

NOKIA 7210

User Guide



NOKIA
CONNECTING PEOPLE

Nokia 7210 User Guide



Phone notes

My Nokia 7210 information		Information source
My number		Wireless provider
International Mobile Equipment Identifier (IMEI)		On back of your phone, beneath the battery
Voicemail number		Wireless provider
Wireless provider customer care		Wireless provider
Message center number		Wireless provider
Default recipient number (e-mail gateway number)		Wireless provider

The wireless phone described in this guide is approved for use in GSM 900, 1800, and 1900 networks.

LEGAL INFORMATION

Part No. 9354676, Issue No. 1

Copyright ©2002 Nokia. All rights reserved.

Nokia, Nokia 7210, Xpress-on Color Covers, Pop-Port, Nokia Connecting People, and the Nokia Original Accessories logos are trademarks or registered trademarks of Nokia Corporation.

Printed in Canada 9/2002

US Patent No 5818437 and other pending patents. T9 text input software
Copyright ©1999-2002. Tegic Communications, Inc. All rights reserved.



Includes RSA BSAFE cryptographic or security protocol software from RSA Security.



Java is a trademark of Sun Microsystems, Inc.

The information contained in this user guide was written for Nokia model 7210 phone. Nokia operates a policy of on-going development. Nokia reserves the right to make changes and improvements to any of the products described in this document without prior notice

UNDER NO CIRCUMSTANCES SHALL NOKIA BE RESPONSIBLE FOR ANY LOSS OF DATA OR INCOME OR ANY SPECIAL, INCIDENTAL, AND CONSEQUENTIAL OR INDIRECT DAMAGES HOWSOEVER CAUSED.

THE CONTENTS OF THIS DOCUMENT ARE PROVIDED "AS IS." EXCEPT AS REQUIRED BY APPLICABLE LAW, NO WARRANTIES OF ANY KIND, EITHER EXPRESS OR IMPLIED, INCLUDING, BUT NOT LIMITED TO, THE IMPLIED WARRANTIES OF MERCHANTABILITY AND FITNESS FOR A PARTICULAR PURPOSE, ARE MADE IN RELATION TO THE ACCURACY AND RELIABILITY OR CONTENTS OF THIS DOCUMENT. NOKIA RESERVES THE RIGHT TO REVISE THIS DOCUMENT OR WITHDRAW IT AT ANY TIME WITHOUT PRIOR NOTICE.

EXPORT CONTROLS

This product contains commodities, technology or software exported from the United States in accordance with the Export Administration regulations. Diversion contrary to U.S. law is prohibited.

FCC/INDUSTRY CANADA NOTICE

Your phone may cause TV or radio interference (for example, when using a telephone in close proximity to receiving equipment). The FCC or Industry Canada can require you to stop using your telephone if such interference cannot be

eliminated. If you require assistance, contact your local service facility. This device complies with part 15 of the FCC rules. Operation is subject to the condition that this device does not cause harmful interference.

Contents

1	Safety first	7
2	An overview of functions	10
	Multimedia messaging service (MMS)	10
	Polyphonic sound (MIDI)	10
	General Packet Radio Service (GPRS)	10
	Speakerphone	11
	Java™ applications	11
	FM stereo radio	11
3	Welcome and quick guide	12
	Get the most out of this guide	12
	Understand wireless network services	13
	Register your phone	13
	E-Newsletters	13
	Understand your phone	14
	Get help	20
	Get started with the Quick Guide	21
	Menu shortcuts	22
	Switch your phone on or off	23
	Check the start screen	24
	Use the selection and scroll keys	26
	Browse phone menus	27
4	Basic operations	32
	Set the clock	32
	Make and answer calls	32
	Call and setup your voicemail	34
	Options during a call	35
	Set up your phone	36
5	Text entry	40
	Standard mode	40
	Predictive text input	41

6	Manage phone security	44
	Security levels	44
	Fixed dialing	45
	Access codes	47
7	The Phone book	50
	View the Phone book menu	50
	Save names and numbers	51
	Copy Phone book entries	55
	1-touch dialing	56
	View Info, Service, and Own numbers	57
8	Menu functions	60
	Messages (Menu 1)	60
	Tips for composing a message	62
	Write and send a text message	64
	Picture messages	66
	E-mail	68
	Multimedia Messages	70
	Voice messages	76
	Automate voicemail	77
	Message options	79
	Organize messages with folders	80
	Delete messages	82
	Call log (Menu 2)	87
	Call log options	87
	View missed calls	88
	View received calls	88
	View dialed numbers	89
	Clear call lists	89
	View call duration	90
	Profiles (Menu 3)	91
	Select a profile	91
	Customize a profile	91

Set a timed profile.....	92
Settings (Menu 4)	94
Call settings	95
Phone settings	100
Display settings	103
Tone settings	105
Alarm clock (Menu 5)	107
Set an alarm.....	107
Turn off an alarm that has been set.....	108
Radio (Menu 6)	109
Turn the radio on and off	109
Use the radio	109
Save a radio channel.....	110
Gallery (Menu 7)	111
Open the Gallery	111
View folders	112
Organizer (Menu 8)	113
Calendar	113
Monthly view.....	114
Go to a date.....	114
Send a Calendar note to another device	116
Make a to-do list.....	117
Games (Menu 9)	119
Launch a game.....	120
Applications (Menu 10).....	121
Launch an application.....	121
Application options	122
Download applications	122
Extras (Menu 11)	124
Use the calculator	124

Use the currency converter	125
Use the countdown timer	126
Use the stopwatch	127
Connectivity (Menu 12)	130
Infrared	130
GPRS	131
Nokia PC Suite	133
Download PC Suite software	133
Services (Menu 13)	134
Notes on wireless Internet access	134
Set up for browsing	135
Sign on to the wireless Internet	135
Use browser options	136
Navigate the wireless Internet	136
Use bookmarks	138
GPRS icons	139
9 Accessories	142
10 Reference information	145
Batteries and chargers	145
Important safety information	147
11 Care and maintenance	153
12 Frequently Asked Questions	155
13 Glossary	158
14 Technical information	160
15 Nokia One-Year Limited Warranty	161
Appendix A	167
Appendix B	171

1 Safety first

Read these simple guidelines. Breaking the rules may be dangerous or illegal. Further detailed information is given in this manual.



Do not switch the phone on when wireless phone use is prohibited or when it may cause interference or danger.



ROAD SAFETY COMES FIRST

Don't use a hand-held phone while driving.



INTERFERENCE

All wireless phones may get interference, which could affect performance.



SWITCH OFF IN HOSPITALS

Follow any regulations or rules. Switch the phone off near medical equipment.



SWITCH OFF IN AIRCRAFT

Wireless devices can cause interference in aircraft.



SWITCH OFF WHEN REFUELING

Don't use the phone at a refuelling point. Don't use near fuel or chemicals.



SWITCH OFF NEAR BLASTING

Don't use the phone where blasting is in progress. Observe restrictions, and follow any regulations or rules.



USE SENSIBLY

Use only in the normal position. Don't touch the antenna unnecessarily.



QUALIFIED SERVICE

Only qualified personnel may install or repair phone equipment.



OBSERVE INFRARED PRECAUTIONS

Do not point the IR beam at anyone's eyes or allow it to interfere with other IR devices.



ACCESSORIES AND BATTERIES

Use only approved accessories and batteries. Do not connect incompatible products.



CONNECTING TO OTHER DEVICES

When connecting to any other device, read its user's guide for detailed safety instructions. Do not connect incompatible products.



BACKUP COPIES

Remember to make backup copies of all important data.





WATER-RESISTANCE

Your phone is not water-resistant. Keep it dry.





CALLING

Ensure the phone is switched on and in service. Enter the phone number, including the area code, then press . To end a call, press . To answer a call, press .



EMERGENCY CALLS

Ensure the phone is switched on and in service. Press  as many times as needed (e.g. to exit a call, to exit a menu, etc.) to clear the display. Enter the emergency number, then press . Give your location. Do not end the call until told to do so.

• ABOUT ACCESSORIES

Check the model number of any charger before use with this device. This device is intended for use when supplied with power from ACP-12 and LCH-9.



Warning: Use only batteries, chargers and accessories approved by the phone manufacturer for use with this particular phone model. The use of any other types may invalidate any approval or warranty applying to the phone, and may be dangerous.

For availability of approved accessories, please check with your dealer.

When you disconnect the power cord of any accessory, grasp and pull the plug, not the cord.

2 An overview of functions

- **MULTIMEDIA MESSAGING SERVICE (MMS)**

Your phone is able to send and receive multimedia messages made up of text and pictures. You may also be able to receive polyphonic ringing tones. You can also save pictures and ringing tones to personalize your phone. See “Multimedia Messages” on page 64 for more information.



This feature uses shared memory. Please see “Shared memory” on page 13 for more information.

- **POLYPHONIC SOUND (MIDI)**

Polyphonic sounds are used in ringing tones and message alert tones. They consist of several sound components played at the same time, like an actual melody through a speaker. Your phone has sound components from over 40 instruments that can be used for polyphonic sounds and the phone can play four instruments simultaneously. The phone supports Scalable Polyphonic MIDI (SP-MIDI) format.

You can receive polyphonic ringing tones via multimedia service, (see “Read and reply to a multimedia message” on page 68), or download them via the gallery menu, see “Gallery (Menu 7)” on page 105 for more information.

- **GENERAL PACKETRADIO SERVICE (GPRS)**

GPRS technology allows mobile phones to send and receive data over a mobile network. Applications such as WAP, MMS, text messaging, and Java™ use GPRS. Your phone supports up to three simultaneous GPRS connections.

For more information on GPRS, see “GPRS” on page 125. Also, consult the PC Connectivity Guide. The PC Connectivity Guide, Nokia PC Suite, and all related software can be downloaded from the U.S. Mobile Phone products section of www.nokia.com.

Before you can use GPRS technology

- Contact your network operator or service provider for availability and subscription to the GPRS service.
- Save the GPRS settings for each of the applications used over GPRS.

PRICING FOR GPRS AND APPLICATIONS

Your wireless provider may charge for GPRS services. For more information on pricing, contact your wireless provider.

• SPEAKERPHONE

You can use your phone as a speakerphone during a call.

- To activate the speakerphone, press **Loudsp**.
- To deactivate the speakerphone during a call, press **Handset**.

The speakerphone deactivates automatically when you end the call, attempt to make a new call, or when you connect a headset.

• JAVA™ APPLICATIONS

Your phone supports Java™ and includes some Java applications and games that have been specially designed for mobile phones. You may be able to download new applications and games to your phone from a PC with Java installer software or from some Mobile Internet services. See “Applications (Menu 10)” on page 115 for more information.



This feature uses shared memory. Please see “Shared memory” on page 13 for more information.

• FM STEREO RADIO

Your phone has an integrated FM stereo radio. You can listen to the radio through a headset or the handsfree speaker (with the headset attached). See “Radio (Menu 6)” on page 103 for more information.

3 Welcome and quick guide

Congratulations on your purchase of the Nokia 7210 mobile phone. Your phone provides many functions which are practical for daily use, such as a Calendar, Radio, Alarm clock, Calculator, and more. A variety of Xpress-on™ color covers are also available. Your phone can also connect to a PC, laptop, or other device using the data cable or built-in IR port. For more information on connectivity, refer to the PC Connectivity Guide. The PC Connectivity Guide, Nokia PC Suite, and all related software can be downloaded from the U.S. Mobile Phone products section of www.nokia.com.

- **GET THE MOST OUT OF THIS GUIDE**

The tips that follow can help you get the most from this guide as you learn to use your phone.

Learn text conventions

This user guide provides text clues to help make instructions clear and easy to follow. These clues are called conventions.

Convention	What it means
bold	The word or phrase appears on the phone's display
bold and blue	The text refers to an address on the world wide web
<i>italics</i>	Indicates emphasis. Pay close attention to any information in italics

Follow graphic clues

This guide uses certain icons to alert you to important information.



Tip: Indicates a shortcut or alternate method of doing something.



Note: Explains a feature or points out an important concept.



Important: Indicates critical information on using a feature.



Caution: Warns when you may lose information.



Warning: Helps you avoid personal injury, damage to the phone, or property damage.

Access alternate formats

This user guide is available in alternate formats, contact Nokia at www.nokiaaccessibility.com or call 1-888-665-4228 for more information.

Look for updates

From time to time, Nokia updates this guide to reflect changes. The latest version may be available at www.nokia.com.

Also, an interactive tutorial may be available at www.nokiahowto.com.

• UNDERSTAND WIRELESS NETWORK SERVICES

The wireless phone described in this guide is approved for use on the GSM 900, GSM 1800, and GSM 1900 networks.

A number of features in this guide are called Network Services. These are special services that you arrange through your wireless service provider. Before you can take advantage of any of these Network Services, you must subscribe to them through your wireless provider and obtain instructions for their use from your service provider.

• REGISTER YOUR PHONE

Make sure to register your phone at www.warranty.nokiausa.com or 1-888-NOKIA-2U (1-888-665-4228) so that we can serve your needs better if you should need to call the center or have your phone repaired.

• E-NEWSLETTERS

When you register your phone, you can sign up for Nokia's e-newsletter, Nokia Connections, if you would like. You will receive tips and tricks on using your phone, accessory information, and special offers.

- UNDERSTAND YOUR PHONE



Use the antenna

Your phone has a built-in antenna. As with any other radio transmitting device, avoid touching the antenna while the phone is powered up.

Contact with the antenna affects call quality and may cause the phone to operate at a higher power level than necessary. Hold the phone as you would any other telephone with the antenna area pointed up and over your shoulder.

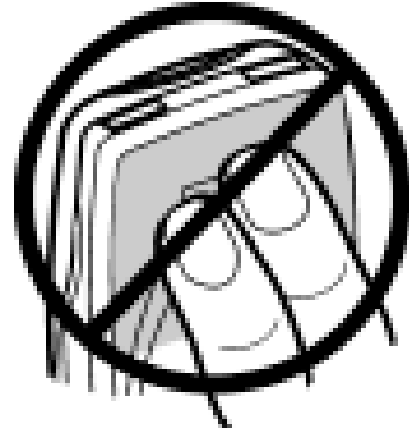

Use the battery

CHARGE THE BATTERY

- 1 Plug the charger transformer in to a standard AC outlet.
- 2 Insert the charger output jack into the round connector at the bottom end of the phone.

After a few seconds, the battery indicator in the display starts to scroll from bottom to top. If the battery is completely flat, it may take a few minutes before the charging indicator appears on the display or any calls can be made.

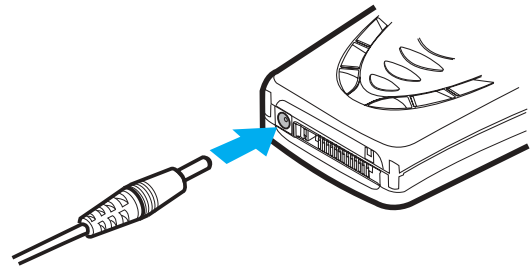

Tip: You can use the phone while the charger is connected.

IMPORTANT BATTERY INFORMATION



Important: Your phone is powered by a rechargeable battery.

Use only batteries approved by Nokia and recharge your battery only with the chargers approved by Nokia. Never use any charger or battery which is damaged.

The battery can be charged and discharged hundreds of times but it will eventually wear out. When the operating time (talk-time and standby time) is noticeably shorter than normal, it is time to buy a new battery.

PROLONG THE BATTERY

Use the following guidelines to obtain the best performance from your battery:

- With your phone turned off, charge your new battery for three hours before its first use. Use the battery until it is fully discharged. Repeat this procedure twice for a total of three charging cycles.
- Note that a new battery's full performance is achieved only after two or three complete charge and discharge cycles. Battery operation time may be less than the estimated times during the first charges. This condition is normal.
- You can use your phone while the battery is charging. However, if the battery is completely empty, it may need to recharge a few minutes before you can make or receive calls or the battery indicator appears.
- After the first charge, you can make and receive calls during the charging cycle, but the calls interrupt the charge. When the phone call ends, the charge will resume.
- The bars on the screen stop scrolling and remain constant when the phone is fully charged. If you leave the phone connected to the charger, the battery receives an additional charge. If you switch the phone on when charging is complete, the message **Battery full** momentarily appears in the display.



Note: The battery will accept a "trickle charge" for an additional two hours.

REMOVE THE BACK COVER

- 1 With the back of the phone facing you, push the back cover release button.
- 2 Lift the bottom of the back cover to remove.

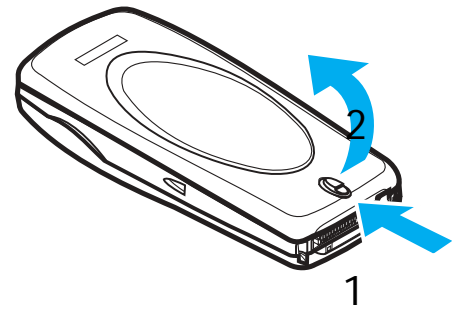

REMOVE THE BATTERY

- 3 After you've removed the back cover, insert your finger into the finger grip and lift the battery from its compartment.

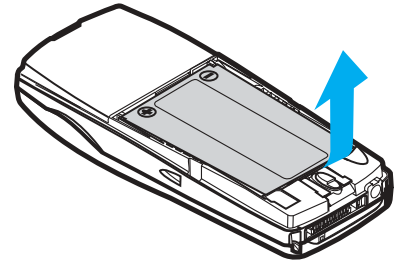

Install the SIM card



Warning: Keep all SIM cards out of reach of small children.

- The SIM card and its contacts can easily be damaged by scratches or bending, so be careful when handling, inserting or removing the card.
- Before installing the SIM card, always make sure that the phone is switched off and that you've removed the cover and battery.

- 1 Slide the SIM card holder toward the bottom end of the phone until it unlocks.

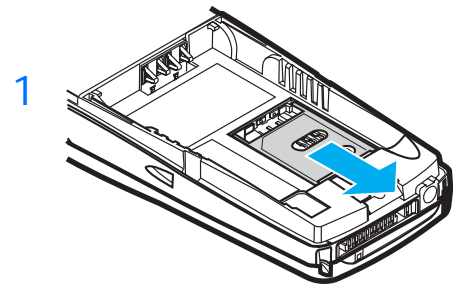

- 2 Swing the SIM card holder open.

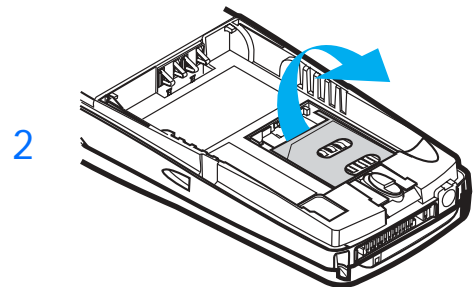

- 3 Insert the SIM card into the holder, (beveled corner last) and the gold contacts facing toward the top end of the phone.

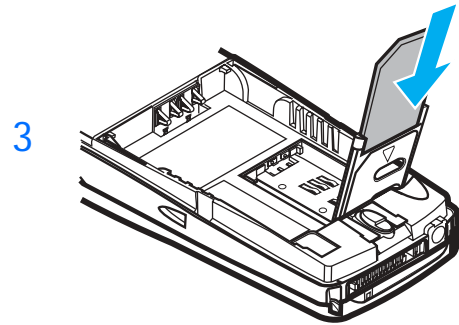

- 4 Close the SIM card holder.

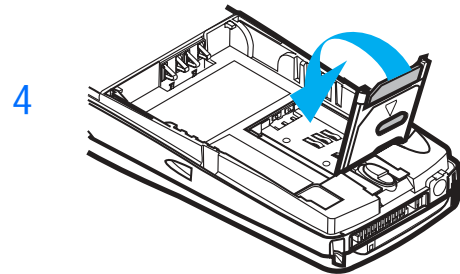

- 5 Slide the SIM card holder toward the top end of the phone until it locks into place.

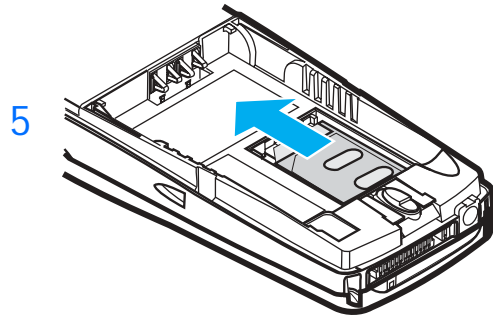

REPLACE THE BATTERY

The SIM card must be installed *before* installing the battery.

- 1 Position the battery so the gold contacts match up with those on the phone. The battery label should be facing *away* from the phone.
- 2 Insert the battery, contact end first into the battery slot.
- 3 Snap the other end of the battery into place.

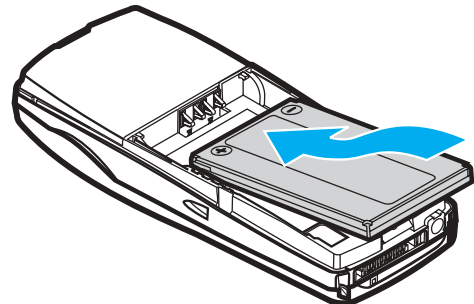

REPLACE THE BACK COVER

- 1 Place the top of the back cover to the locking catch in the top of the phone.
- 2 Position the back cover over the locking catches on the both sides of the phone and press down to lock the cover into place.

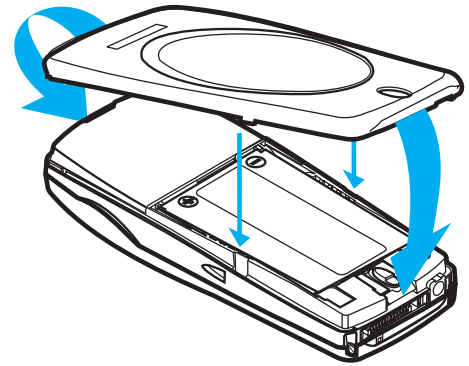

Shared memory

The following features in your phone use shared memory: Phone book, text and multimedia messages, images and ringing tones in gallery, calendar and to-do notes, and Java™ games and applications. Using any of these features leaves less memory for other features. This is especially true with heavy use of any of the features. For example, saving many images may take all of the shared memory and your phone may display that the memory is full. In this case, delete some of the information or entries reserving the shared memory.

The following functions share dynamic memory that is dependent on the data quantity per item and shared memory available at a time in the Nokia 7210:

- Phone book (up to 300 entries)
- SMS messages (up to 150 text messages or 50 picture/concatenated messages)
- Calendar notes (up to 250 entries)
- To-do list (up to 30 entries)
- Fixed ring tones (11 present, not removable)

The following features share a memory pool of 725 kB:

- MMS (max size of 45 kB per MMS message)
- Ring tones (20 preset, all removable)
- Images (10 preset all removable)
- Java applications (3 preset, max download size 64 kB per application)

The following functions use static memory:

- WAP cache (up to 20 entries)
- WAP bookmarks (up to 30 entries)
- WAP security cache and certificates (up to 20 entries)

• GET HELP

Find your phone's label

If you need help, Nokia Customer Care is available for assistance. Before calling, however, please read "Frequently Asked Questions" on page 149.

We also recommend that you write down the following information and have it available if you call. The information can be found on back of the phone, beneath the battery.

- The International Mobile Equipment Identifier (IMEI)
- We also ask that you write down your zip code.

Information label

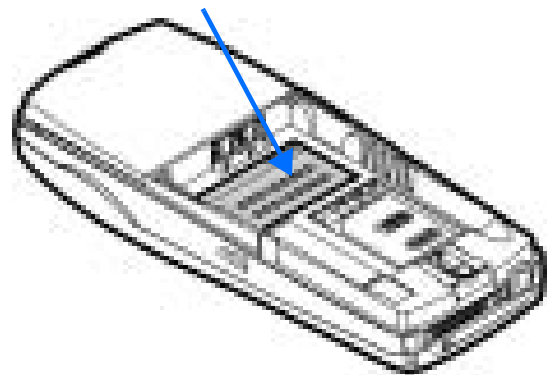





Contact Nokia

Have your phone or accessory with you when contacting Nokia.













Nokia Customer Care Center, USA	Customer Interaction Center, Canada
Nokia, Inc. 7725 Woodland Center Boulevard, Suite 150 Tampa, Florida 33614 Tel: 1-888-NOKIA2U (1-888-665-4228) Fax: 1-813-249-9619 TTY: 1-800-24NOKIA (hearing impaired only) (1-800-246-6542)	Nokia Products Ltd. 601 Westney Road South Ajax, Ontario L1S 4N7 Tel: 1-888-22NOKIA (1-888-226-6542) Fax: 1-905-427-1070

• GET STARTED WITH THE QUICK GUIDE

Make a call	Enter phone number, press 
Answer a call	Press Answer or 
Answer a call with a call waiting	Press  or Options and select Answer call
End a call	Press 
Ignore a call	Press Silence when your phone rings
Redial last number	Press  twice
Adjust call volume	Press up or down on the side volume key
Use the in-call menu	While in a call, press Options
Use 1-touch dialing	Press and hold any key 2 through 9
Save a name and number	Enter a number, press Options , and select Save , then enter a name and press OK
Recall a name/number	Press Names , select Find . Enter name and press Find or List
Check voice mail	Press and hold 1∞ OR dial your voice mailbox number
Write and send a text message	Press Menu 01-1-1 . After a pause, write the message. Press Options , scroll to Send , press Select , enter the recipient's number, press OK
Write and send an E-mail message	Press Menu 01-1-2 . After a pause, enter the recipient's e-mail address. Press OK , enter a subject, and press OK . Write your e-mail message, press Options , scroll to Send e-mail and press Select . Enter the e-mail server number if necessary and press OK . Your e-mail is sent.
Read a new message	Press Show , then press Select
Reply to a message	Press Options , select Reply , write the reply, press Options , select Send , and press OK
Reply to an E-mail message	Press Options , scroll to Reply , and press Select . Compose your message and press Options . Scroll to Sending options and press Select . Scroll to Sending profile and press Select . Highlight your email profile and press Select . Press Options , Accept , enter the e-mail address, press OK .
Send a business card	Recall a name from the phone book. Press Details , then press Options , scroll to Send bus. card , scroll to Via text message and press Select . Enter the recipient's number or press Find to retrieve a number from the Phone book. Press OK . The business card is sent.

• MENU SHORTCUTS

To access a menu or item, press "Menu," then enter the numbers associated with the desired menu or item. For example, press Menu 2-2-1 (Call log - Missed calls) to view any Missed calls.

- | | | |
|-----------|---|------|
| 1 | MESSAGES  | |
| | Text messages | 01-1 |
| | Multimedia messages | 01-2 |
| | Chat | 01-3 |
| | Voice messages | 01-4 |
| | Info messages | 01-5 |
| | Message settings | 01-6 |
| | Service commands | 01-7 |
| 2 | CALL LOG  | |
| | Missed calls | 2-1 |
| | Received calls | 2-2 |
| | Dialed numbers | 2-3 |
| | Delete recent call lists | 2-4 |
| | Call timers | 2-5 |
| | Call costs | 2-6 |
| | GPRS Data counter | 2-7 |
| | GPRS Connection timer | 2-8 |
| 3 | PROFILES  | |
| | Normal | 3-1 |
| | Silent | 3-2 |
| | Meeting | 3-3 |
| | Outdoor | 3-4 |
| | Pager | 3-5 |
| 4 | SETTINGS  | |
| | Time and date settings | 4-1 |
| | Call settings | 4-2 |
| | Phone settings | 4-3 |
| | Display settings | 4-4 |
| | Tone settings | 4-5 |
| | Accessory settings | 4-6 |
| | Security settings | 4-7 |
| | Restore factory settings | 4-8 |
| 5 | ALARM CLOCK  | |
| 6 | RADIO  | |
| 7 | GALLERY  | |
| 8 | ORGANIZER  | |
| | Calendar | 8-1 |
| | To-do list | 8-2 |
| 9 | GAMES  | |
| | Select game | 9-1 |
| | Game downloads | 9-2 |
| | Memory | 9-3 |
| | Settings | 9-4 |
| 10 | APPLICATIONS  | |
| | Select application | 10-1 |
| | App. downloads | 10-2 |
| | Memory | 10-3 |
| 11 | EXTRAS  | |
| | Calculator | 11-1 |
| | Countdown timer | 11-2 |
| | Stopwatch | 11-3 |
| 12 | CONNECTIVITY  | |
| | Infrared | 12-1 |
| | GPRS | 12-2 |
| 13 | SERVICES  | |
| | Home | 13-1 |
| | Bookmarks | 13-2 |
| | Service inbox | 13-3 |
| | Settings | 13-4 |
| | Go to address | 13-5 |
| | Clear the cache | 13-6 |

Contact your service provider

To use the network services available in your phone, you'll need to sign up with a wireless provider. In many cases, the wireless provider will make available descriptions of their services and instructions for using features such as:

- Voice mail and voice privacy
- Call waiting, call forwarding, and caller ID
- Messaging
- News and information services
- Selected Internet services

Wireless providers may differ in their support of features. Before you sign up, make sure a wireless provider supports the features that you need.

Receive accessibility information

Nokia is committed to making mobile phones easy to use for all individuals, including those with disabilities. For more information, visit the Nokia World Wide Web site www.nokiaaccessibility.com.

• SWITCH YOUR PHONE ON OR OFF



Warning: Do not switch the phone on when wireless phone use is prohibited or when it may cause interference or danger.

- 1 To turn your phone on or off, press and hold the power key on top of the phone for at least 3 seconds.

If the phone displays **Insert SIM card** even though the SIM card is properly inserted, or **SIM card not supported**, contact your wireless provider.

- 2 Enter the PIN code if necessary and press OK.
- 3 Enter the security code if necessary and press OK.

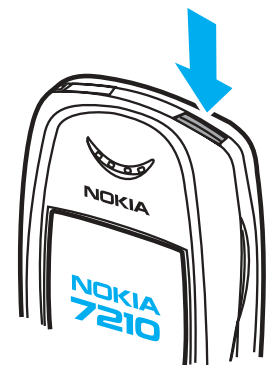







Note: If the language that appears in your display is not correct, see “Set the display language” on page 94 for information on changing your phone’s display language.

- **CHECK THE START SCREEN**

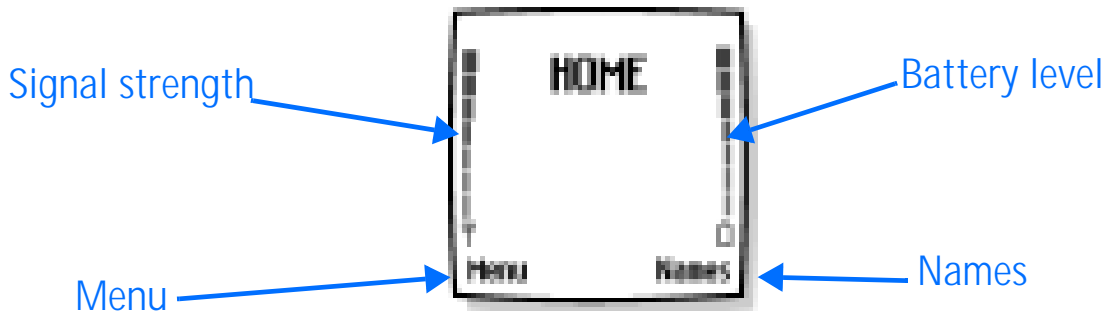



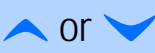









The Start screen is “home base” and indicates your phone is in idle mode.







What’s on the Start screen







HOME	Your wireless provider’s name may appear here
Signal strength	A higher bar indicates a stronger network signal
Battery level	A higher bar indicates more power in the battery
	Left selection key; press this key when Menu is on the Start screen to enter the menu list
	Right selection key; press this key when Names is on the Start screen to enter the Phone book
 or 	Scroll keys; press either of these keys at the Start screen to display any entries in your Phone book

Understand indicators and icons



Icon	Indicates...
	You have one or more text or picture messages. See "Reply to a message or e-mail" on page 63
	You have one or more multimedia messages. See "Read and reply to a multimedia message" on page 68
	You have one or more voice messages. See "Voice messages" on page 70
	Your phone's keypad is locked, see "Lock the keypad (Keyguard)" on page 38
	Your phone is set to the Silent profile. "Profiles (Menu 3)" on page 85
	The alarm clock is set to On . See "Alarm clock (Menu 5)" on page 101
	The countdown timer is running. See "Use the countdown timer" on page 120
	The stopwatch timing is running in the background, see "Use the stopwatch" on page 121
	A GPRS dial-up connection is established, see "GPRS dial-up connections" on page 126
	You have an incoming or outgoing call during a GPRS dial-up connection. GPRS is suspended
	IR connection indicator, see "Infrared" on page 124
	Forward all voice calls. All calls are forwarded to another number. If you have two phone lines, the indicator for line 1 is  and for line 2 
	If you have two phone lines, indicates that you are on the 2nd phone line. See "Phone settings" on page 94

Icon	Indicates...
	Integrated handsfree is active, see "Speakerphone" on page 5
	Calls are limited to a closed user group; see "Closed user groups" on page 43
	The timed profile is selected, see "Profiles (Menu 3)" on page 85
 ,  or 	A headset, handsfree or loopset accessory is connected to the phone

• USE THE SELECTION AND SCROLL KEYS

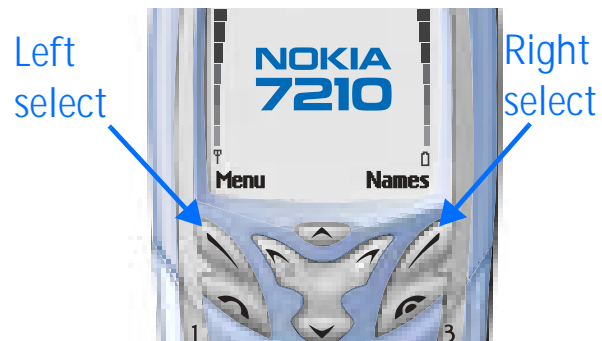
Below each corner of the display are the selection keys. Press  when **Menu** appears above it to show the first of numerous menus. Page through the rest of the menus using the up and down scroll keys ( ). Press  when **Names** appears above it to enter the Phone book.





Tip: Press an up or down scroll key ( ) from the Start screen to view any entries in your Phone book.

Use four-way scrolling

In features, such as the calendar monthly view, text messages, and special characters, you can move the cursor up and down as well as left and right. To move the cursor:



Left, press 

Up, press 
Down, press 

Right, press 

• BROWSE PHONE MENUS

Your phone's features are grouped according to function and are accessed through your phone's main menus. Each main menu contains submenus and lists from which you can select or view items, and customize your phone's features. You can access these menus and submenus by using the *scroll method* or by using a *shortcut*.



Note: Some features may not be available, depending on your network. For more information, contact your wireless provider.

Use the scroll method

- 1 At the Start screen, press **Menu**, then scroll through the main menus using the up and down scroll keys (▲▼).

As you scroll through the menus, the menu number appears in the upper right corner of the display. Below the menu number is a scroll bar with a tab. The tab moves up or down as you scroll through the menus, providing a visual representation of your current position in the menu structure

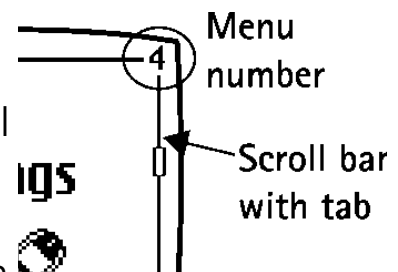

- 2 When you arrive at a menu, press **Select** (↵) to enter that menu's submenus.
 - Press **Back** (←) to return to the previous menu
 - Press **Home** (🏠) to return to the Start screen from any menu or submenu

Use a shortcut

You can go directly to almost any menu or submenu, as well as activate most features by using a shortcut.

- Press **Menu**, then within 3 seconds, press the key or keys associated with the menu function you'd like to view or activate.

For example, to select the **Meeting** profile, press **Menu 3-3-1** from the Start screen (Menu - ³Profiles - ³Meeting - ¹Select). After a brief

pause, the Meeting profile is activated.

A complete list of shortcuts begins on the following page.

Check in-phone help

Many features have brief descriptions (help text) which can be viewed on the display. To view these descriptions, scroll to a feature and wait for about 10 seconds. Press **More** to view all of the description (if necessary), or press **Back** to exit.

ACTIVATE OR DEACTIVATE HELP TEXT

- 1 At the Start screen, press **Menu 4-3-7** (Settings > Phone settings > Help text activation).
- 2 After a brief pause, **On** and **Off** appear in the display.
- 3 Scroll to **On** or **Off** and press **Select**. A confirmation message appears in the display indicating your selection.

Menu shortcuts

1 MESSAGES

To access a menu or item, press "Menu," then enter the numbers associated with the desired menu or item. For example, press Menu 2-2-1 (Call log - Missed calls) to view any Missed calls.

TEXT MESSAGES.	01-1
Create message	01-1-1
Create e-mail	01-1-2
Inbox	01-1-3
Sent items	01-1-4
Archive	01-1-5
Templates	01-1-6
My folders	01-1-7
Delete messages	01-1-8
MULTIMEDIA MSGS	01-2
Create message	01-2-1
Inbox	01-2-2
Outbox	01-2-3
Sent items	01-2-4
Saved items	01-2-5
Delete messages	01-2-6
CHAT	01-3
VOICE MESSAGES.	01-4
Listen to voice messages	01-4-1
Voice mailbox number	01-4-2
INFO MESSAGES.	01-5
Info service	01-5-1
Topics	01-5-2
Language	01-5-3
Info topics saved on SIM card	01-5-4

Read (if received only)	01-5-5
MESSAGE SETTINGS	01-6
Text messages	01-6-1
Multimedia msgs.	01-6-2
Other settings	01-6-3
SERVICE COMMANDS	01-7

2 CALL LOG

MISSED CALLS	2-1
RECEIVED CALLS	2-2
DIALED NUMBERS	2-3
DELETE RECENT CALL LISTS.	2-4
All	2-4-1
Missed	2-4-2
Received	2-4-3
Dialed	2-4-4
CALL TIMERS.	2-5
Duration of last call	2-5-1
Duration of dialed calls	2-5-2
Duration of received calls	2-5-3
Duration of all calls	2-5-4
Clear timers	2-5-5
CALL COSTS.	2-6
Last call units	2-6-1
Units of all calls	2-6-2
Call cost settings	2-6-3
GPRS DATA COUNTER	2-7
Data sent in last session	2-7-1
Data received in last session	2-7-2
All sent data	2-7-3
All received data	2-7-4
Clear counters	2-7-5
GPRS CONNECTION TIMER.	2-8
Duration of last session	2-8-1
Duration of all sessions	2-8-2
Clear timers	2-8-3

3 PROFILES

NORMAL3-1

- Select 3-1-1
- Customize 3-1-2
 - Ringling options 3-1-2-1
 - Ringling tone 3-1-2-2
 - Ringling volume 3-1-2-3
 - Vibrating alert 3-1-2-4
 - Message alert tone . . . 3-1-2-5
 - Keypad tones 3-1-2-6
 - Warning tones 3-1-2-7
 - Alert for 3-1-2-8
- Timed 3-1-3

SILENT 3-2

- Select 3-2-1
- Customize 3-2-2
 - Ringling options 3-2-2-1
 - Ringling tone 3-2-2-2
 - Ringling volume 3-2-2-3
 - Vibrating alert 3-2-2-4
 - Message alert tone . . . 3-2-2-5
 - Keypad tones 3-2-2-6
 - Warning tones 3-2-2-7
 - Alert for 3-2-2-8
- Profile name 3-2-2-9
- Timed 3-2-3

Submenus for Meeting, Outdoor, and Pager are the same as Silent

MEETING. 3-3

OUTDOOR 3-4

PAGER. 3-5

4 SETTINGS

TIME AND DATE SETTINGS . . 4-1

- Clock 4-1-1
- Date 4-1-2

- Auto-update
of date & time 4-1-3

CALL SETTINGS 4-2

- Call forwarding 4-2-1
- Anykey answer 4-2-2
- Automatic redial 4-2-4
- 1-touch dialing 4-2-4
- Call waiting 4-2-5
- Summary after call 4-2-6
- Send my caller identity . . 4-2-7
- Line for outgoing calls¹ . . 4-2-8

PHONE SETTINGS. 4-3

- Language 4-3-1
- Automatic keyguard 4-3-2
- Cell info display 4-3-3
- Welcome note 4-3-4
- System selection 4-3-5
- Confirm SIM
service actions 4-3-6
- Help text activation 4-3-7
- Start-up tone 4-3-8

DISPLAY SETTINGS. 4-4





- Wallpaper 4-4-1
- Color schemes 4-4-2
- Screen saver timeout 4-4-3
- Operator logo 4-4-4
- Display brightness 4-4-5





TOE SETTINGS 4-5

- Ringling options 4-5-1
- Ringling tone 4-5-2
- Ringling volume 4-5-3
- Vibrating alert 4-5-4
- Message alert tone 4-5-5
- Keypad tones 4-5-6
- Warning tones 4-5-7
- Alert for 4-5-8

ACCESSORY SETTINGS 4-6

¹ For availability, contact your wireless provider.

- Headset 4-6-1
 - Default profile. 4-6-1-1
 - Automatic answer . . 4-6-1-2
- Loopset 4-6-2
 - Use loopset 4-6-2-1
 - Automatic answer . . 4-6-2-2
 - Automatic answer . . 4-6-2-3
- SECURITY SETTINGS 4-7**
 - PIN code request 4-7-1
 - Call restrictions 4-7-2
 - Fixed dialing 4-7-3
 - Closed user group. 4-7-4
 - Security level 4-7-5
 - Access codes. 4-7-6
- RESTORE
FACTORY SETTINGS 4-8**
- 5 ALARM CLOCK **
- 6 RADIO **
 - OPTIONS. 6-1
- 7 GALLERY **
- 8 ORGANIZER **
 - CALENDAR 8-1
 - TO-DO LIST. 8-2
- 9 GAMES **
 - SELECT GAME. 9-1
 - GAME SERVICES. 9-2
 - MEMORY 9-3
 - SETTINGS 9-4
 - Game sounds 9-4-1
 - Game lights 9-4-2
 - Shakes. 9-4-3

- 10 APPLICATIONS **
 - SELECT APPLICATION. 10-1
 - APP. DOWNLOADS. 10-2
 - MEMORY. 10-3
- 11 EXTRAS **
 - CALCULATOR. 11-1
 - COUNTDOWN TIMER. 11-2
 - STOPWATCH 11-3
- 12 CONNECTIVITY **
 - INFRARED 12-1
 - GPRS 12-2
 - GPRS modem settings . 12-2-1
 - GPRS connection. 12-2-2
- 13 SERVICES **
 - HOME 13-1
 - BOOKMARKS. 13-2
 - SERVICE INBOX 13-3
 - SETTINGS. 13-4
 - Active service settings . 13-4-1
 - Edit active service settings 13-4-2
 - Appearance settings. . . 13-4-3
 - Cookie settings 13-4-4
 - Authority certificates . . 13-4-5
 - Service inbox settings. . 13-4-6
 - GO TO ADDRESS 13-5
 - CLEAR THE CACHE. 13-6

4 Basic operations

• SET THE CLOCK

Before many functions such as call timers and other features will operate properly, you need to set the clock.

- 1 At the Start screen, press **Menu 4-1-1** (Settings - Time and date settings - Clock).

After a brief pause, **Show clock** (or **Hide clock**) **Set the time**, and **Time format** appear in the display with **Show clock** (or **Hide clock**) highlighted.



- 2 Scroll to **Set the time** and press **Select**.
- 3 Enter the time (in hh:mm format) and press **OK**.
- 4 Scroll to **am** or **pm** and press **Select**. The time is set.

• MAKE AND ANSWER CALLS





Note: Your phone must be switched on to use this function. Do not switch the phone on when wireless phone use is prohibited or when it may cause interference or danger.

Use the keypad

- 1 Enter the phone number (including the area code), and press .
 - To delete a character to the left of the cursor, press **Clear**.
- 2 Press  to end the call or to cancel the call attempt.



Use the phone book

- 1 At the Start screen, press  or  and scroll to the entry you wish to view.
- 2 Press  to make the call or press **Details** to view details of the entry.



Tip: To quickly search the list of entries in your Phone book, press any key in which the letters match the first letter of the name for which you're searching.

Answer or reject an incoming call

- Press  to answer the call
- Press  to reject the call; the call is diverted to your voicemail

If you press **Silence**, only the ringing tone is muted. You can then either answer or reject the incoming call.



Tip: If the HDB-4 or HDS-3 headset is connected, you can answer or end a call by pressing the key on the headset.



Answer a call with the keypad locked

To answer a call with keyguard on, simply press . During the call, all features function as normal. When you end or reject the call, the keypad automatically re-locks.



Note: When Keyguard is on, calls may be possible to dial emergency numbers (for example, 911 or other official emergency numbers). Key in the emergency number and press . The number is displayed only after you have keyed in its last digit.

Redial the last number

- 1 At the Start screen, press  to display the last 20 numbers you have dialed.
- 2 Press  to redial the last number, or scroll to the number (or name) you wish to redial and press .

Adjust the earpiece volume

- To increase the volume of a call, press the volume up key on the left side of the phone.
- To decrease the volume of a call, press the volume down key on the left side of the phone.

When adjusting the volume, a bar chart appears in the display indicating the volume level.

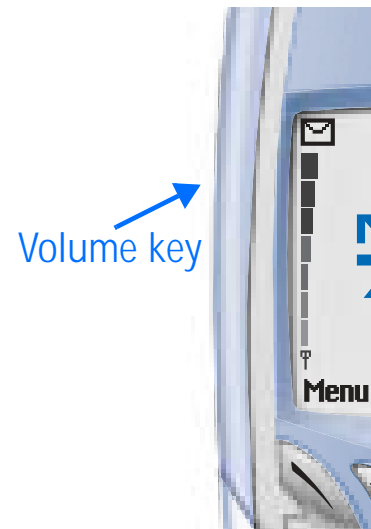

• CALL AND SETUP YOUR VOICEMAIL

- 1 Once you've saved the voice mailbox number, press and hold **1∞**.
- 2 When you connect and the pre-recorded greeting begins, follow the automated instructions to setup your voicemail.

Listen to your voice messages

Once you've setup voicemail, you can dial the number one of 3 ways:

- Dial the number using the keypad
- Press and hold **1∞**
- Press Listen if there's a notification message in the display

When you connect and the pre-recorded greeting begins, follow the automated instructions to listen to your voice messages.

Make a conference call

Conference calling is a network service that allows up to six persons to take part in a conference call.

- 1 Make a call to the first participant.
- 2 To call a new participant, press **Options**, scroll to **New call**, and press **Select**.
- 3 Enter the phone number of the new participant (or press **Find** to retrieve a number from your Phone book) and press **Call**. The first call

is put on hold.

- 4 When the new call picks up, press **Options**, scroll to **Conference**, and press **Select** to connect the calls.
- 5 To add a new participant to the call, repeat steps 2 through 4.

HAVE A PRIVATE CONVERSATION WITH ONE OF THE PARTICIPANTS:

- 6 Press **Options**, select **Private** and select the desired participant. Rejoin the conference call as described in step 4.
- 7 To end the conference call, press .

• **OPTIONS DURING A CALL**

Many of the options that you can use during a call, are network services. Press **Options** during a call to display those listed in the following table.

- Scroll to an option and press **Select** to activate the option or enter its submenu

Option	Function
Mute	Mute your voice; you can hear the other party but they can't hear you
Unmute	Return to normal from mute status
End call	End the call
End all calls	End all calls within a conference call
Phone book	Open the Phone book menu
Menu	Display the main menus
Hold	Place the current call on hold
Unhold	Remove the current call from hold status
New call	Place a new call; the first call is put on hold
Conference	Call another party and invite them into the call
Private	Have a private conversation with one participant in a conference call

Option	Function
Answer	Answer another incoming call
Reject	Reject a call; the calling party receives a busy signal
Loudspeaker	Enable the handsfree feature in your phone
Handset	Disable handsfree and return to normal use (earpiece)
Touch tones	Send touch tones generated by your phones keypad
Swap	Switch between the active call and the call on hold

Press **Swap** to switch between the active call and the call on hold, **Transfer** to connect a call on hold, and  to disconnect yourself from all calls.

• SET UP YOUR PHONE

Use the Optional headset

The HDB-4 may be purchased with your phone or separately as an accessory.

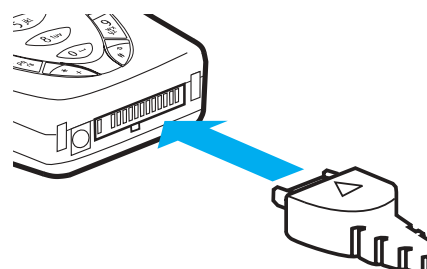

Connect the headset

- 1 Plug the headset jack into the Pop-Port™ connector at the bottom end of your phone.





- 2 Position the headset on your ear as it appears in the illustration to the right.

With the headset connected, you can make, answer, and end calls as usual.

- Use the keypad to enter numbers
- Press  to place a call
- Press  to end a call



Adjust display brightness

- 1 Press Menu 4-4-5 (Settings - Display settings - Display brightness).
After a brief pause, a bar chart appears in the display indicating the current brightness level.
- 2 Press  or  to adjust the brightness to your preference.

Change the Xpress-on™ covers

-  **Important:** Before changing covers, ensure the phone is powered off and disconnected from the charger or any other device. Always store and use the phone with the covers attached.

REMOVE THE BACK COVER

- 1 Push the back cover release toward the top of the phone.
- 2 Lift the back cover away from the phone to remove.

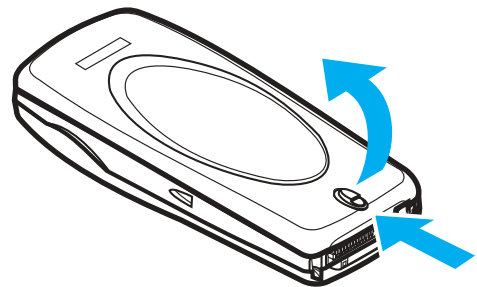

REMOVE THE BATTERY

- 3 After you've removed the back cover, insert your finger into the finger grip and lift the battery from its compartment.

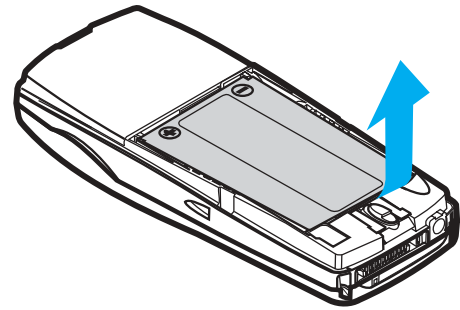

REMOVE THE FRONT COVER

- 4 Press the front cover latch on the top of the phone while gently pulling the top of the front cover away from the rest of the phone.

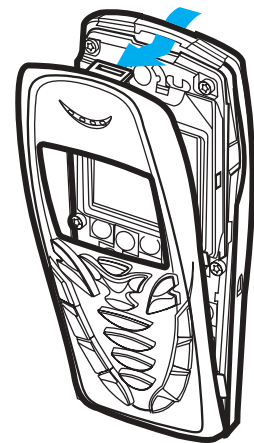

INSTALL THE KEYPAD AND NEW FRONT COVER

- 5 Remove the key mat from the old front cover and place it into the new front cover as shown.

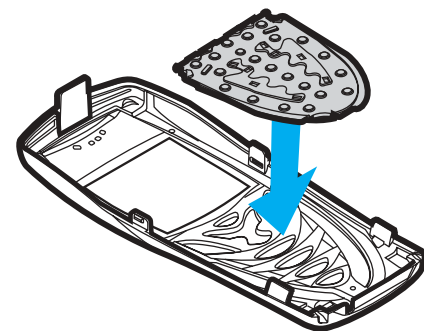

- 6 Insert the latches from the bottom of the new front cover into the matching holes at the bottom of the phone.
- 7 Gently push the latches from the middle of the front cover into the matching holes in the middle of the phone.
- 8 Gently push the cover latch on the top of the front cover through the locking hole in the top of the phone, and snap the cover into place.
- 9 Install the battery, and then match the top of the back cover to the locking catch in the top of the phone.
- 10 Position the back cover over the locking catches on both sides of the phone, and press down to lock the cover into place.

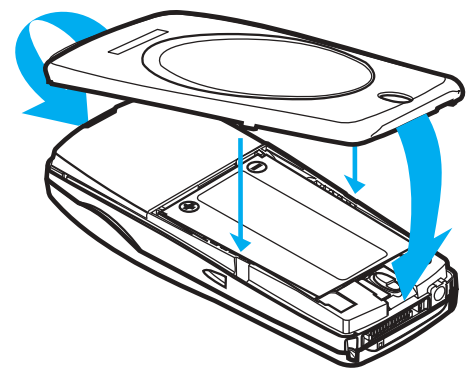
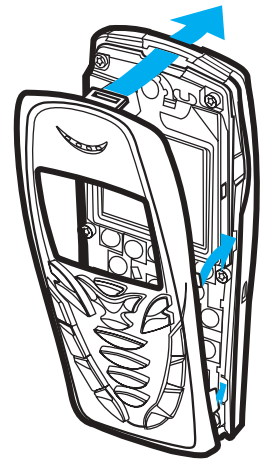

5 Text entry

You can use two methods for entering text and numbers.

- The **standard mode** is the only way to enter names into such things as the Phone book, calendar notes, and renaming caller groups
- **Predictive text input** is a quick and easy method for writing messages

• STANDARD MODE

Enter text (Abc)

- Press a key once to insert the first letter on the key, twice for the second letter, and so on. If you pause briefly, the last letter in the display is accepted and your phone awaits the next entry.
- Press **0**– to enter a space thereby accepting a completed word
- Press **1**∞ to enter a period (.)
- Press ***+** to display special characters. See more about special characters on the following pages

Enter numbers (123)

To switch to 123 mode from **Abc** mode, press and hold **#**↕ at any message entry screen until the icon in the upper left corner of the display switches from **Abc** to **123** (or vice versa).

CLEAR THE SCREEN

- Press **Clear** to backspace the cursor and delete a character
- Press and hold **Clear** to backspace continuously and delete

Enter punctuation and special characters

While at any text entry screen, press ***+** to display special characters (press and hold ***+** if predictive text is on). The following special characters are available

.	,	'	?	!	"	-	()	@	/
:	_	;	+	&	%	*	=	<	>	£
€	\$	¥	α	[]	{	}	\	~	^
ı	¿	§	#		└	⬅				

Use four-way scrolling

Navigate special characters using the scroll keys much as you would a joystick. Once a character is highlighted, press **Insert** to insert the character into your message.

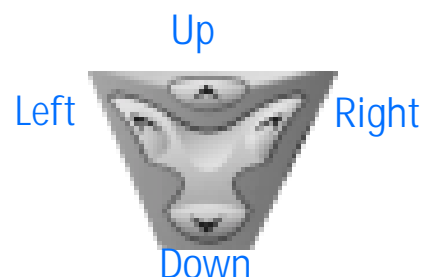

• PREDICTIVE TEXT INPUT

Predictive text input allows you to quickly write messages using your keypad and the phone's built-in dictionary. You can use predictive text to write messages, create a calendar notes, make to-do lists, and more.

Activate/deactivate predictive text

- At a text entry screen, press and hold **Options**. **T9 prediction off** or **T9 prediction on** appears (depending on the prior mode).

OR

- If predictive text is off, press **Options**, scroll to **Predictive text**, and press **Select**.
- Scroll to the language of your choice and press **Select**.

Predictive text is turned on. The predictive text icon () appears in

the upper left corner of the display.

 **Note:** The Language setting in predictive text affects the time and date formats of the Clock, Alarm clock, and Calendar.

Write with predictive text

For example, to write *Nokia* with the English dictionary selected, press each of the following keys only *once*: (with predictive text on). The illustration below simulates your display each time a key is pressed.



PREDICTIVE TEXT TIPS

- Press **0** to enter a space and begin writing the next word
- If a displayed word is not correct, press ***+** to see other matches
- If ? appears after a word, press **Spell** to add the word to the dictionary
- Press **1∞** to insert a period into your message
- Press and hold **Options** to turn predictive text on and off
- Press and hold ***+** to display special characters. See “Enter punctuation and special characters” and “Use four-way scrolling” on the previous page for the easiest way to enter special characters

 **Note:** Press **#^** to switch predictive text on and off or to cycle through the various modes available. As you press **#^**, the following icons (not descriptions) appear in the display:

 Uppercase text Predictive text is Off	 Sentence case text Predictive text is On
 Lowercase text Predictive text is Off	 Lowercase text Predictive text is On

Add new words to the dictionary

If you encounter a word that predictive text doesn't recognize, a question mark (?) follows the word and **Spell** appears in the lower left of the display.

- Press **Spell**, enter your new word using the keypad, and press **Save**.

The word is added to the dictionary as well as the message you're writing.

NOTES ABOUT ADDING WORDS

- New words that you accept by pressing **Select**, **0←**, or deleting the space between two words are saved to the dictionary.
- Depending on the language and the length of the words, you may be able to add hundreds of words to the dictionary.
- When the dictionary is full, the most recent addition replaces the first.

6 Manage phone security

Lock the keypad (Keyguard)

Remember to lock your phone's keypad to prevent accidental calls. If the keypad is locked, it unlocks when you receive a call. After the call, the lock automatically reactivates.



Important: When Keyguard is on, calls may be possible to dial emergency numbers (for example, 911 or other official emergency numbers). Key in the emergency number and press . The number appears in the display after you've keyed in the last digit.

- To lock the keypad, press Menu ***+**.

Unlock the keypad

- At the Start screen, press Unlock ***+**.

• SECURITY LEVELS

The security level determines your access to features when a "non-owner" SIM card is used. A "non-owner" SIM card is one (other than the original) that is inserted after you power off the phone. There are 3 security levels:

Security levels

Off	Owner and Non-owner cards are treated the same
Memory	Non-owner cards can access SIM memory. Any changes to the memory setting requires the security code.
	The owner card has access to all features, but the security code is required to change a memory setting
Phone	The security code is required upon power-up

Set your security level

- 1 At the Start screen, press Menu 4-7-5 (Settings - Security settings - Security level).

- 2 After a brief pause, you're prompted to enter the security code. The default code is 12345. Enter the security code and press OK.
- 3 Scroll to **Off**, **Memory**, or **Phone** and press **Select**. A message appears in the display confirming your selection

• FIXED DIALING

Once you setup and activate a fixed dialing list, your phone can make calls *only* to those numbers that you've defined in the fixed dialing list. Fixed dialing is a network feature and must be supported by your wireless provider.



Note: When fixed dialing is set on, calls may be possible to certain emergency numbers in some networks (such as 911 or other official emergency numbers).

Set up and activate a fixed dialing list

- 1 At the Start screen, press **Menu 4-7-3** (Settings - Security Settings - Fixed dialing). After a brief pause, the options in the following table appear in the display.

Fixed dialing options

On	Activate fixed dialing (see note above)
Off	Deactivate fixed dialing
Number list	View the numbers in your fixed dialing list



Note: If you activate fixed dialing and the number list is empty, all outgoing calls, except for emergency numbers such as 911, require entry of the PIN2 code.

- 2 Scroll to **Number list** and press **Select**. **Fixed dialing not active** and then **Fixed dialing list empty** appear in the display.
- 3 You're prompted to enter the PIN2 code. Enter the PIN2 code and press OK.

- 4 Enter the fixed dialing number, or press **Find** to retrieve a number from your Phone book and press **OK**.
- 5 Enter a name for the number and press **OK**. A confirmation note appears in the display and you're returned to the fixed dialing number list.
- 6 Press **Back**, scroll to **On**, and press **Select** to activate fixed dialing.

View or edit the fixed dialing list

- 1 At the Start screen, press **Menu 4-7-3** (Settings - Security Settings - Fixed dialing).
- 2 Scroll to **Number list** and press **Select**.
- 3 You're prompted to enter the PIN2 code. Enter the PIN2 code and press **OK**.
- 4 Any numbers which you've assigned to fixed dialing appear in the display.
- 5 Scroll to a number and press **Options**.
- 6 The options in the following table appear in the display.

Fixed dialing number options

View number	View the number for an entry
Add	Add a number to your fixed dialing list
Edit	Edit the highlighted entry
Delete	Delete the highlighted entry
Delete all	Delete all entries in your fixed dialing list

- Use the scroll keys to highlight an option
- Press **Select** to activate or enter an option's submenu

Notes about fixed dialing

- If a SIM card with fixed dialing that is activated is inserted into a phone that doesn't support fixed dialing, the SIM card is rejected
- If you try to add a name (without a number) to the fixed dialing list, you'll receive an error message
- If you try to browse the fixed dialing list, but haven't stored any numbers, **Fixed dialing list empty** appears in the display
- You cannot access SIM memory manually (view or copy numbers on the SIM card) while fixed dialing is active

• ACCESS CODES

Use access codes to change your security code, PIN code, and PIN2 code.



Note: Avoid using codes similar to emergency numbers such as 911 to prevent accidental dialing of the emergency number.

The security code

The security code controls access to features such as the security level and is supplied with the phone. The preset code is 12345.



Note: If you enter the wrong security code five times in succession, you won't be able to enter a code for five minutes, even if you power off the phone between incorrect entries.

CHANGE YOUR SECURITY CODE

Once you change the security code from its preset of 12345, keep the new code secret, and in a safe place separate from your phone.

- 1 Press **Menu 4-7-6-1** (Settings - Security settings - Access codes - Change security code).

After a brief pause, you're prompted to enter the current security code (default is 12345).

- 2 Enter the current security code and press **OK**. You're prompted to enter the new security code.
- 3 Enter the new security code (up to 10 characters) and press **OK**.

You're asked to re-enter the new security code for verification.

- 4 Enter the new security code again and press **OK**. A message appears in the display confirming your security code has been changed.

The PIN code

The PIN code protects the SIM card from unauthorized access. The PIN code can be 4- 8 digits in length. After three successive incorrect entries the PIN code is blocked and you'll be asked to enter the personal unblocking key (PUK) code.



Note: The PIN code must be obtained from your wireless provider. The PIN code is typically provided with your SIM card.

PIN CODE REQUEST

Enable your phone to request the PIN code upon power-up. This provides extra security in case your phone is lost or stolen.

- 1 Press **Menu 4-7-1** (Settings - Security settings - PIN code request).
- 2 After a brief pause, you're prompted to enter the current PIN code. Enter the PIN code and press **OK**.
- 3 Scroll to **On** and press **OK**. A message appears in the display confirming your selection.

CHANGE YOUR PIN CODE

Before you can change your PIN code, you'll need to enable **PIN code request**. See "PIN code request" immediately preceding this section.

- 1 Press **Menu 4-7-6-2** (Settings - Security settings - Access codes - Change PIN code).
- 2 After a brief pause, you're prompted to enter the current PIN code. Enter the PIN code and press **OK**.
- 3 You're prompted to enter the new PIN code. Enter the new PIN code and press **OK**.
- 4 You're prompted to re-enter the new PIN code for verification. Enter the new PIN code again and press **OK**.

A message appears in the display confirming your PIN code has been changed.

The PIN2 Code

The PIN2 code is required for features such as Fixed dialing. If you enter an incorrect PIN2 code three times in succession, the PIN2 code is blocked and you'll have to enter the PUK2 code.



Note: The original PIN2 code must be obtained from your wireless provider.

CHANGE YOUR PIN2 CODE

- 1 Press Menu 4-7-6-3 (Settings - Security settings - Access codes - Change PIN2 code). You're prompted to enter the current PIN2 code.
- 2 Enter the current PIN2 code and press OK. You're prompted to enter the new PIN2 code.
- 3 Enter the new PIN2 code and press OK. You're asked to verify the new PIN2 code by entering it again.
- 4 Enter the new PIN2 code again and press OK. A message appears in the display confirming you've changed the PIN2 code.

Personal unblocking key (PUK) codes

PUK and PUK2 codes are used to restore blocked PIN and PIN2 codes. Both PUK and PUK2 codes are eight characters in length and cannot be changed. PUK and PUK2 codes must be obtained from your wireless provider.



Important: If you enter an incorrect PUK or PUK2 code 10 times in succession, the message SIM rejected appears in the display and the SIM card can no longer be used. You must contact your wireless provider for a new SIM card.

Closed user groups

A closed user group is a network service that specifies the group of people whom you can call and who can call you. For more information contact your network operator or service provider.

7 The Phone book

Your Phone book can save up to 300 names, with multiple numbers and text notes for each name. The amount of numbers and text entries that you can save may vary, depending on their length and the total number of entries in the Phone book.



Note: This feature uses shared memory. Please see “Shared memory” on page 13 for more information.

• VIEW THE PHONE BOOK MENU

- 1 At the Start screen, press the right selection key () under Names. The menu items in the left column of the following table appear in the display.
- 2 Scroll to an item. Press Select to activate the feature or enter its submenu.

Menu item	Function
Find	Find a name or select from a list
Add entry	Add a name to your Phone book
Edit name	Edit an existing name
Delete	Delete a name and its associated numbers
Copy	Copy entries from Phone memory to SIM and vice versa
Add number	Add a number to an existing name
Settings	Set memory in use (Phone or SIM), change your Phone book view, and check the memory status of your Phone and SIM card

Menu item	Function
1-touch dialing	Display the list of 1-touch dialing numbers saved to memory
Service numbers	Display a list of numbers related to your wireless provider
Own numbers	View the numbers (line 1, line 2, data) in use by your SIM card
Caller groups	View and edit the properties (such as the ring tone) for any of the caller groups

- **SAVE NAMES AND NUMBERS**

You can save names and numbers to phone memory or to SIM memory.

Quickly save a name and number

- 1 At the Start screen, enter the phone number you wish to save.
- 2 Press **Options**, ensure **Save** is highlighted, and press **Select**.
- 3 Enter a name for the number and press **OK**. A confirmation message appears in the display indicating your entry has been saved.

Quickly save (only) a number

You can save a phone number as a stand-alone entry in your phonebook.

- 1 At the Start screen, enter the number you wish to save.
- 2 Press and hold **Options**. A message appears in the display confirming your number is saved.

Save an entry using the Phone book menu

- 1 At the Start screen, press **Names**, scroll to **Add entry** and press **Select**.
- 2 Enter a name using the keypad and press **OK**.
- 3 Enter a number and press **OK**.

- 4 Press **Done** to return to the Start screen.

Save addresses and notes

To save an email address, you'll need to add it to an existing entry (name).

- 1 Find the entry (name) in your Phone book to which you'd like to add an address or note.
- 2 With the entry highlighted, press **Details**.
- 3 Press **Options**, scroll to **Add detail** and press **Select**.
- 4 Scroll to the address or note of your choice and press **Select**.
- 5 Enter the text for the note or address and press **OK**.



Select your Phone book view and memory

- 1 Press **Names**, scroll to **Settings**, and press **Select**.
- 2 Scroll to any of the options in the following table. Press **Select** to enter the option's submenu.

Option	Function
Memory in use	Select the memory you wish to use. Options are Phone , SIM card , or Phone and SIM combined. With Phone and SIM selected, names and numbers are saved to phone memory but entries saved to both memories appear in the display
Phone book view	Select the Name list , Name and number , or Name only view
Memory status	View the amount of phone or SIM memory used as well as the amount of phone or SIM memory available

Save multiple numbers and text items per name

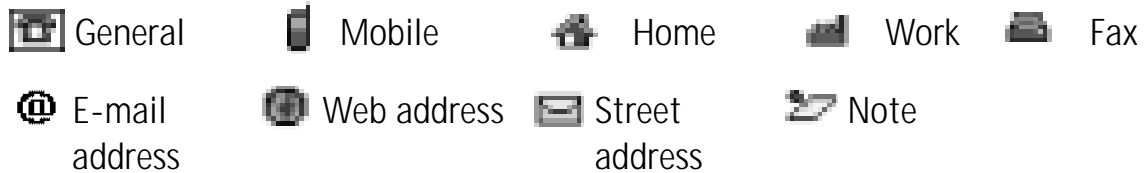

You can save different types of phone numbers and short text items per name to the Phone book. The first number you save for any entry is automatically set as the default, or primary number.

- 1 At the Start screen, press  or  and scroll to the entry to which you wish to add a number or text item.
- 2 Press **Details**, and then press **Options**.
- 3 Scroll to **Add number** or **Add detail** and press **Select**.
- 4 Scroll to one of the following types and press **Select**:









- 5 Enter the number or text for the type you've selected and press **OK**.
 - To change the type, select **Change type** in the options list.

CHANGE THE DEFAULT (PRIMARY) NUMBER

- 1 At the Start screen, press  or , scroll to the entry you wish to change and press **Details**.
- 2 Scroll to the number you wish to set as default and press **Options**.
- 3 Scroll to **As primary no.** and press **Select**.

Search for a name in the Phone book

- 1 At the Start screen, press  or  to display the contents of your Phone book.
- 2 Press the key which corresponds to the first letter of the name for which you are performing a search.
- 3 Press  or  to scroll up and down through names in the list.
Press  or  to move the cursor left or right in the search window at the bottom of the display, if necessary.

- 4 Press **Details** to view the details of the selected name.

Edit a name, number or text item

- 1 Search for the entry as described in the previous section and press **Details**.
- 2 Scroll to the name, number or text item you wish to edit and press **Options**.
- 3 Scroll to **Edit name**, **Edit number**, or **Edit detail** and press **Select**.
- 4 Edit the name, number, or detail to your preference and press **OK**.

Delete names and numbers

- 1 At the Start screen, press **Names**, scroll to **Delete**, and press **Select**.
- 2 To delete individual names and numbers, scroll to **One by one** and press **Select**.
- 3 Scroll to the entry you wish to delete, press **Delete**, and press **OK** to confirm the deletion.
- 4 To delete the entire contents of your Phone book, scroll to **Delete all**, then scroll to the phone book you wish to delete (**Phone** or **SIM card**).
- 5 Press **Delete**, then press **OK** to confirm. You're asked to enter the security code.
- 6 Enter the security code and press **OK**.

• COPY PHONE BOOK ENTRIES

- 1 At the Start screen, press **Names**, scroll to **Copy**, and press **Select**.
- 2 Scroll to **From phone to SIM card** or **From SIM card to phone** and press **Select**. The following options appear in the display:

One by one	Select and copy entries one by one
All	Copies all entries from the SIM card or Phone
*Primary nos.	Copies only primary numbers. This appears only if you select From phone to SIM .

- 3 Scroll to the copy method of your choice and press **Select**.
 - a) If you selected **One by one**, go to step 4.
 - b) If you selected **All** or **Primary nos.**, go to step 6.
- 4 Scroll to the entry you wish to copy and press **Copy**.
- 5 Scroll to **Keep original** or **Move original** and press **Select**. The entry is copied and you're returned to the list of Phone book entries.
- 6 If you selected **All** or **Primary nos.** in step 3, scroll to **Keep original** or **Move original** and press **Select**.
- 7 Press **OK** to confirm your choice. All entries are copied to the selected destination. Press **Back** to return to the list of Phone book entries, or press  to exit and return to the Start screen.

 **Caution:** Select **Keep original** if you're unsure of which copy method to use. This ensures original entries are merely copied to the new location. **Move original** deletes files after copying.

Send and receive business cards

You can send and receive an entry in your Phone book via IR or text message, if supported by your wireless provider.

RECEIVE A BUSINESS CARD VIA IR

- 1 Press **Menu 12-1** (Connectivity - Infrared) to ensure IR is activated.
When you receive the business card, your phone beeps and a message

appears in the display.

- 2 Select **Save** to save the business card in the phone's memory, or press **Exit** (or **OK**) to discard the business card.

SEND A BUSINESS CARD

You can send a business card via IR or as an text message to a compatible phone or other handheld device.

- 1 Highlight an entry from the Phone book that you wish to send and press **Details**.
- 2 Press **Options**, scroll to **Send bus. card** and press **Select**.
 - To send the business card via IR, make sure the receiving device is set up to receive data via its IR port and select **Via infrared**.
 - To send the business card as a message, select **Via text message**.
- 3 If you selected **Via infrared** (and the entry has multiple sub-entries) scroll to **Primary no.** or **All details** and press **Select**. Your business card is sent.
- 4 If you selected **Via text message** (and the entry has multiple sub-entries), scroll to **Primary no.** or **All details** and press **Select**.
- 5 Enter the number for your recipient or press **Find** to retrieve a number from your Phone book.
- 6 Press **OK** and the business card is sent.

• 1-TOUCH DIALING

You can associate any entry in your Phone book with keys **2^{abc}** through **9^{wzx}** and then dial those entries by pressing and holding the assigned key.

Assign a key to 1-touch dialing

- 1 At the Start screen, press **Names**, scroll to **1-touch dialing** and press **Select**.
- 2 Scroll to any empty slot and press **Assign**.

- 3 Enter the number (including the area code) and press **OK**, or press **Find** to retrieve a number from your Phone book.
- 4 Enter a name for the number and press **OK**.
 - If 1-touch dialing is off, the phone displays a prompt asking if you'd like to turn 1-touch dialing on. Press **Yes** to activate 1-touch dialing.
- 5 The entry appears in the slot you've assigned.

Make a call with 1-touch dialing

- Press and hold the key to which an entry has been assigned. Your phone dials the entry assigned to the key.

CHANGE 1-TOUCH DIALING NUMBERS

- 1 At the Start screen, press **Names**, scroll to **1-touch dialing** and press **Select**.
- 2 Scroll to the 1-touch dialing entry you wish to change and press **Options**.
- 3 Scroll to **Change** and press **Select**.
- 4 Enter the new number, or press **Find** to retrieve a number from your Phone book, and press **OK**.
- 5 Enter a name for the entry and press **OK**.

DELETE 1-TOUCH DIALING NUMBERS

- 1 At the Start screen, press **Names**, scroll to **1-touch dialing** and press **Select**.
- 2 Scroll to the 1-touch dialing location you wish to delete and press **Options**.
- 3 Scroll to **delete** and press **Select**. You're asked to confirm the deletion.
- 4 Press **OK** to delete the key assignment.

- **VIEW INFO, SERVICE, AND OWN NUMBERS**

Your wireless provider may have saved your phone's operating number, as well as various information and service numbers to your SIM card.



Note: This feature may not be supported by your SIM card. If so, contact your wireless provider for more information.

- 1 Press **Names** at the Start screen, scroll to one of the number types in the following table, and press **Select**.

Number type	Used this number to...
Info numbers	Contact your wireless provider to obtain information
Service numbers	Contact your wireless provider to obtain service
Own numbers	Display the operating number, or numbers which have been assigned to your phone by your wireless provider

- 2 To view details of any of the number types in the previous table, press **Details** when the number type appears in the display.

Caller groups

You can add Phone book entries to any of 5 caller groups, and then assign a unique ringing tone or graphic to that group. This enables you to identify callers from the group by their unique ringing tone or graphic. A caller group can be as small as one person or as large as your entire Phone book. Caller groups can be renamed to suit your preference.

CALLER GROUP OPTIONS



- 1 At the Start screen, press **Names**, scroll to **Caller groups**, and press **Select**. The following Caller groups are available.

Family VIP Friends Business Other

- 2 Use the scroll keys (▲▼) to highlight a group. Press **Select** to display the following caller group options:

Rename group	Rename the group to your preference
Group ringing tone	Set the ringing tone for the group
Group logo	Turn the graphic for the caller group on or off
Group members	Add or remove members from the caller group

Setup a caller group

- 1 At the Start screen, press  or  to display a list of entries in your Phone book.



Tip: Perform a “quick find” when Phone book entries are displayed by entering the first letter of a name.  appears at the bottom of the display to indicate you’re performing a search.

- 2 Scroll to a name you’d like to add to a caller group and press **Details**.
- 3 Press **Options**, scroll to **Caller groups**, and press **Select**.
- 4 Scroll to the caller group to which you’d like to add the name and press **Select**. A confirmation message appears in the display.

8 Menu functions

Messages (Menu 1)



If you've subscribed to a message service, you can send and receive messages to compatible phones that are also subscribed to a message service. You can also send and receive picture messages, multimedia messages, and e-mail if supported by your network. Composed messages can be up to 450 characters in length.

Linked messages

Your phone can send and receive long messages (up to 450 characters) in sequences. While receiving linked messages, you can start reading the first part before the phone has received the entire message.

While viewing the message, you may see *some text missing* on the display. This is normal, and the message content will be updated as soon as the missing sequence arrives.

If the memory is full, you may have to delete a message from your inbox or outbox before your phone can update the missing text.



Before you can send and receive messages



You'll need the following to send and receive messages:

- A messaging service through your wireless provider
- A message center number, which must be saved to your phone (if your wireless provider hasn't done so already)

Message icons

Icons that precede the title of a message indicate the following:

	The message has not been read
	The message has been read

	A message (which you've composed) has not been sent
	The message is a delivery report
	The message is a MMS (multimedia message)

Choose your message type

You can choose the type of message sent by your phone. Types include Text and Fax.



Note: The default message type is Text.



Note: This feature must be supported by your wireless provider.

- 1 At the Start screen, press **Menu 01-6** (Messages - Message settings).
- 2 After a brief pause, **Text messages** appears highlighted. Press **Select**.
- 3 **Sending profile** is highlighted. Press **Select**.
- 4 **Default profile** is highlighted. Press **Select**.
- 5 Scroll to **Messages sent as** and press **Select**.
- 6 Scroll to the message type of your choice and press **Select**. A message appears in the display confirming your selection.

Save your message center number

Messages sent by your phone are routed through your wireless provider's message center. Normally, this number is saved to your phone by your wireless provider. To save the number manually, do the following:

- 1 At the Start screen, press **Menu 01-6** (Messages - Message settings).
- 2 **Text messages** is highlighted. Press **Select**.
- 3 **Sending profile** is highlighted. Press **Select**.
- 4 **Default profile** is highlighted. Press **Select**.
- 5 *If the box in the display is empty*, enter the number given by your wireless provider and press **OK**.

- 6 If the box in the display is full, edit the number *only* if you are sure the number is incorrect, or you'd like to change the number, and press OK.

A message appears in the display confirming your number is saved.

• TIPS FOR COMPOSING A MESSAGE

Predictive text input

Predictive text allows you to write messages using a built-in dictionary. It's much faster than using the traditional "multi-tap" method. For each letter of the word that you're spelling, you only need to press the corresponding key on your keypad *once*. You can use predictive text to write a message, create a calendar note, make a to-do list, and more.

Activate/deactivate predictive text

- At any text entry screen, press and hold **Options**. Predictive text is turned on (or off), depending on its previous mode.

OR

- 1 At a text entry screen, press **Options**, scroll to **Predictive text**, and press **Select**.
- 2 Scroll to the language of your choice and press **Select**.

Predictive text is turned on. The predictive text icon () appears in the upper left corner of the display.

-  **Note:** The Language setting affects the time and date formats of the Clock, Alarm clock, and Calendar.

Use predictive text

For example, to write *Nokia*, with the English dictionary selected, press each of the following keys *once*: (with predictive text on):









The illustration above simulates your display each time a key is pressed.

- Press **0-** to enter a space and begin writing the next word.
- If a displayed word is not correct, press ***+** to see other matches. To return to the previous word in the list of matches, press **Previous**.
- If **?** appears after a word, press **Spell** to add the word to the dictionary.
- Press **1∞** to insert a period into your message.
- Press and hold ***+** to display special characters. Press ***+** again to cycle through all available characters. See “Use special characters” in the following section for more information on special characters.



Note: Press **#^** to switch predictive text on or off and to use predictive text in various modes. As you press **#^**, the following icons (not the descriptions) appear in the upper left of the display:

 Uppercase text Predictive text is Off	  Sentence case text Predictive text is On
 Lowercase text Predictive text is Off	  Lowercase text Predictive text is On

Add new words to the dictionary

If you encounter a word that predictive text doesn't recognize, a question mark (?) follows the word and **Spell** appears in the lower left of the display.

- Press **Spell**, enter your new word using the keypad, and press **Save**.

The word is added to the dictionary as well as the message you're writing.

NOTES ABOUT ADDING WORDS

- New words that you accept by pressing **Select**, **0-**, or deleting the space between two words are saved to the dictionary.
- Depending on the language and the length of the words, you may be able to add hundreds of words to the dictionary.

- When the dictionary is full, the most recent addition replaces the first.

Use special characters





While entering text, press and hold ***+** to display the following special characters. Press ***+** again to cycle through all available characters:

.	,	'	?	!	"	-	()	@	/
:	_	;	+	&	%	*	=	<	>	£
€	\$	α	[]	{	}	\	~	^	i
¿	§	#	┌	←						

Use four-way scrolling

In features, such as the calendar monthly view, text messages, and special characters, you can move the cursor up and down as well as left and right.



Left, press  Up, press 
Down, press  Right, press 

• WRITE AND SEND A TEXT MESSAGE



Note: This feature uses shared memory. Please see "Shared memory" on page 13 for more information.

- 1 At the Start screen, press Menu 01-1-1 (Messages - Text messages > Create message).



Tip: To go quickly to the Create message display, press  at the Start screen.

- 2 After a brief pause, the message entry screen appears in the display.

- 3 Compose a message using the keypad and press **Options**.
- 4 Scroll to **Send** and press **Select**.
- 5 Enter the recipient's phone number, or press **Find** to retrieve a number from your Phone book, and press **OK**. Your message is sent.

Read messages

When you receive a message, your phone beeps and **Message received** appears in the display as well as the unopened letter icon (✉).

- 1 Press **Show** to read the message, or **Exit** to move it to your inbox.



Note: When you have unopened messages in your inbox, ✉ is shown in the upper left corner of the Start screen as a reminder.

- 2 Use the scroll keys (▲ or ▼) to view the whole message if necessary.



Tip: Keep scrolling to view other information, such as the sender number and time the message was sent.

- 3 Press **Back** to move the message to the Inbox, or press **Options** for other choices, such as **Reply** or **Forward**.

Read linked messages

Your phone can receive one long message (up to 450 characters) in sequences. You can start reading the first part before the phone has received the entire message.

While viewing the message, you may see **some text missing** on the display. This is normal, and the message content will be updated as soon as the missing sequence arrives.

If the memory is full, you may have to delete a message from your inbox or outbox before your phone can update the missing text.

Reply to a message

- 1 While viewing a message, press **Options**, scroll to **Reply**, and press **Select**.
- 2 Compose your reply using the keypad, then press **Options**, scroll to **Send**, and press **Select**.

- 3 The number of the original sender appears in the display. Press OK and your reply is sent.

Forward a message

- 1 While viewing a message, press **Options**.
- 2 Scroll to **Forward** and press **Select**.
- 3 Enter the recipient's phone number, or press **Find** to retrieve a number from your Phone book.
- 4 Press **OK**. The message is forwarded.

• PICTURE MESSAGES



Note: This feature uses shared memory. Please see "Shared memory" on page 13 for more information.

Your phone comes with 10 pre-loaded pictures. You can, however, overwrite any of the 10 pictures that come with your phone. Pictures can be attached to a message and sent via text message to compatible phones. Picture messages behave the same as text messages, but pictures take up more space than text. Pictures are stored in the "Templates" folder under Messages - Templates.



Note: You cannot send a picture message via e-mail.

Download pictures

Your phone can download pictures, or receive them from compatible phones via text messaging to use in messages. You can also create pictures and send them to your phone or other compatible phones using Nokia PC Suite.





Note: This function can be used only if it is supported by your wireless provider. Only phones that offer picture message features can receive and display picture messages. Contact your wireless provider for details.

When you receive a picture message

When you receive a picture message, your phone beeps and Message received appears in the display as well the message icon ().

- 1 Press **Show** to view the picture message, or press **Exit** to move it to your inbox.
- 2 If you have more than one picture message, scroll to the message of your choice and press **Select** to view the message.

 **Note:** When you have unopened picture messages in your inbox,  is shown in the upper left corner of the Start screen as a reminder.

- 3 Use the scroll keys to view the whole picture if necessary.

 **Tip:** Keep scrolling to view other information, such as the sender number and time the message was sent.

- 4 Once you're finished, press **Back** to move the picture message to the Inbox, or press **Options** for other choices, such as **Reply** or **Forward**.

TO SAVE THE PICTURE

If you'd like to save the picture to your Templates folder for later use:

- 1 Press **Options**, scroll to **Save picture**, and press **Select**. You can then enter a title for the picture and press **OK**.

 **Note:** If your templates folder is full of pictures, just scroll to the picture you'd like to replace and press **Select**.

Compose and send a picture message

One picture message is equivalent in size to 3 text messages. When you insert a picture into a message, you'll have enough remaining space for about 121 characters in the message. If you try and insert a picture into a message that is almost full of text, a beep sounds and you're prompted to delete some text before proceeding.

- 1 At the Start screen, press **Menu 01-1-1** (Messages - Text messages - Create message).

After a brief pause, the message edit screen appears in the display.

- 2 Write a message using the keypad (or enter nothing if you choose to just send a picture), and press **Options**.



Tip: Insert pictures before adding text. You can then check remaining space for text in the upper right corner of the display.

- 3 Scroll to **Insert picture** and press **Select**. A list of pictures appears in the display.
- 4 Scroll to a picture and press **View**.
- 5 Press **Insert** to insert the picture into your message, otherwise:
 - a) Press **Back**, scroll to another picture, and press **View** again.
 - b) Press **Insert** to insert the picture into your message.
- 6 To send the picture message, press **Options**, scroll to **Send**, and press **Select**.
- 7 Enter the phone number for your recipient (or press **Find** to retrieve a number from your Phone book) and press **OK**. The message is sent.

PREVIEW, CHANGE, OR DELETE A PICTURE MESSAGE

- 1 After a picture has been inserted into your message, press **Options** at the message edit screen.
- 2 Scroll to one of the following options and press **Select**.
 - a) **Preview** - Previews the inserted message before sending. Press **Back** to return to the list of options.
 - b) **Change picture** - Takes you back to the picture list. Scroll to highlight a new picture, press **View** and then press **Insert** to replace the previous picture in your message.
 - c) **Delete picture** - Press **OK** to delete the picture from your message, or press **Back** to return to the list of options.

• **E-MAIL**

You can send e-mail up to 160 characters in length to anyone with an e-mail address. First, you'll need to setup an e-mail profile and modify a few other settings. It takes just a few minutes, and you only need to do this once.



Important: The e-mail address is included in the total character count for an e-mail message, which is 160 characters.



Note: You cannot insert pictures into e-mail.



Note: Wireless providers may customize the text message settings interface. For more details about text message services, please contact your wireless provider.

Write and send e-mail



Note: See “Tips for composing a message” on page 56 for ways to write messages faster.

- 1 At the Start screen, press **Menu 01-1-2** (Messages - Text messages - Create e-mail).

After a brief pause, you're prompted to enter the e-mail address.

- 2 Enter the e-mail address, or press **Find** to retrieve an e-mail address from your Phone book, and press **OK**.
- 3 Enter a subject for the e-mail and press **OK**.
- 4 Compose your e-mail using the keypad and press **Options**.



Tip: Be sure and leave enough space in the total character count (160) for the e-mail address.

- 5 Scroll to **Send e-mail**, if necessary, and press **Select**. Your e-mail is sent.

Reply to a message or e-mail

When you have received a text message or e-mail, , the number of new messages and ___ **Message(s) received** appears in the display.





Note: The blinking  indicates that the message memory is full. Before you can receive new messages, delete some of your old messages. See “Delete messages” on page 76 for more information.

- Press **Show** to view the message now, or **Exit** to view it later.

READING THE MESSAGE LATER:

- 1 Press Menu, and select Messages, Text messages and Inbox.
- 2 If more than one message is received, select the message you want to read and press Select.

An unread text message is indicated by  in front of the message, and an unviewed picture message by .

• MULTIMEDIA MESSAGES



Note: This feature uses shared memory. Please see “Shared memory” on page 13 for more information.

A multimedia message (MMS) can contain text and images. Your phone has a multimedia message viewer for playing messages and a multimedia inbox for storing saved messages. Once you save the multimedia message, you can use the image as a screen saver.



Note: This function can be used only if it is supported by your wireless provider. Only compatible devices can receive and display multimedia messages.

A multimedia message can contain text and images. Your phone supports multimedia messages of up to 45 kB. If the maximum size is exceeded, the phone may not be able to receive the message. Depending upon your network, you may receive a message that includes an Internet address where you can go to view the multimedia message.

Pictures included in multimedia messages are scaled down to fit the size of your display.



Note: The default setting of the multimedia message service is on, and your wireless provider may charge for messages received.

Multimedia messaging supports the following picture formats: JPEG, GIF, PNG, OTA-BMP and WBMP.



Note: If a received message contains unsupported elements, they may be replaced with the text **Object format not supported**

Define MMS settings

Before you can use the multimedia message feature, you need to first define the way you want to receive the messages.

ALLOW MULTIMEDIA RECEPTION

You can choose to receive all messages or to receive messages only when you are in the service provider's home network.

- 1 At the Start screen, press Menu 01-6-2-2 (Messages - Message settings - Multimedia msgs. - Allow multimedia reception). After a brief pause, a list of options appears in the display.
 - Yes to allow all incoming messages
 - In home system to allow incoming messages only if you are in the service provider's home system.
- 2 After selecting one of the reception options, scroll to **Incoming multimedia messages**, then press **Select**.
- 3 Scroll to **Retrieve**, then press **Select**.

BLOCK MULTIMEDIA RECEPTION

- 1 At the Start screen, press Menu 01-6-2-2 (Messages - Message settings - Multimedia msgs. - Allow multimedia reception). After a brief pause, a list of options appears in the display.
- 2 Scroll to **No** and press **Select**.

ALLOW OR NOT ALLOW ADVERTISEMENTS

- 1 At the Start screen, press Menu 01-6-2-5 (Messages - Message settings - Multimedia msgs. - Allow advertisements). After a brief pause, **Yes** and **No** appear in the display.
- 2 Scroll to the setting of your choice and press **Select**.

Other MMS settings

Other multimedia settings include saving your messages to the **Sent** items folder and editing your connection settings.

- 1 At the Start screen, press Menu 01-6-2 (Messages - Message settings - Multimedia msgs.). After a brief pause, a list of options appears in the display.
- 2 Scroll to an option. Press Select to activate the option or to enter its submenu.

Message Setting	Function
Save sent messages	Saves sent multimedia messages to the Sent items folder
Allow multimedia reception	Chooses Yes, No, or In home network for your multimedia service. In home network can't receive multimedia messages outside the home network.
Incoming multimedia messages	Select Retrieve to receive multimedia messages, or Reject if you don't wish to receive multimedia messages.
Connection settings	Define WAP settings for retrieving multimedia messages. Activate the set where you want to save the connection settings and then edit the settings.
Allow advertisements	Allows you to enable or disable reception of automatic multimedia advertisements

Edit multimedia connection settings

- 1 At the Start screen, press Menu 01-6-2-4 (Messages - Message settings - Multimedia msgs. - Connection settings).
- 2 Scroll to Edit active multimedia settings and press Select.

- 3 The connection settings in the following table appear in the display. Scroll to a setting. Press Select to enter the setting's submenu.

Connection setting	Function
Settings' name	Rename the setting to your preference
Homepage	Enter the homepage where your browser retrieves multimedia messages
Session mode	Select session modes Temporary or Permanent
Data bearer	Select the data bearer
GPRS access point	Define the access point
IP address	Enter or change the IP address
Authentication type	Select from Normal or Secure
User name	Edit or enter your user name
Password	Edit or enter a password

ABOUT CONNECTION SETTINGS

You may be able to receive multimedia connection settings as a text message from your wireless provider. For more information, contact your wireless provider.

SELECT A FONT SIZE FOR YOUR MESSAGES

- 1 Press Menu 01-6-3-1 (Messages - Message settings - Other settings - Font size). After a brief pause a list of choices appear in the display.
- 2 Scroll to Small font or Large font and press Select. A message appears in the display confirming your selection.

Write and send a multimedia message

For availability and subscription to the multimedia messaging service, contact your wireless provider.



- 1 At the Start screen, press **Menu 01-2-1** (Messages - Multimedia messages - Write message). After a brief pause, the message entry screen appears in the display.
- 2 Enter the text of your message and press **Options**.
- 3 Scroll to **Insert image** and press **Select**.
- 4 Choose your image from the list and press **Select**.
- 5 Scroll to **Send to number** or **Send to e-mail** and press **Select**.



Note: If you've attached a picture to the message, you cannot send the message via e-mail.

- 6 Enter the number of the recipient, or the e-mail address and press **Select**. The message is sent.

Read and reply to a multimedia message

When a multimedia message is being received,  appears (blinking) in the display. Once the message has been fully downloaded,  and **Multimedia message received** appears in the display.

- 1 To view the message, press **Show**. To view the message later, press **Exit** (and then **No** when asked to discard).
- 2 While viewing the message, press **Options**. Some or all of the following options may appear in the display. Scroll to an option and press **Select** to activate the option or enter its submenu.

Option	Function
Delete message	Delete a saved message
Reply	Reply to the message. Press Options and then Send . The sender's phone number or e-mail is used as the default
Forward to no.	Forward the message to another number

Option	Function
Forward to e-mail	Forward the message to an e-mail address
Edit	Edit the message. You can only edit messages that you've written
Details	View the message subject, size, and class
Save tone	Save a ringing tone, if included, to the gallery
Zoom in	Enlarge the picture
Save image	Save any picture that is attached to your picture gallery



Note: If  blinks and **Multimedia memory full**, view waiting msg. appears in the display, memory for multimedia messages is full. You need to delete some of your old messages. See "Delete messages" on page 76 for more information.

Chat

You can have a conversation with another person using this "faster text messaging" application. You can't save messages, but you can view them while chatting. Chat messages costs about the same as text messages.

START A CHAT SESSION

- 1 At the Start screen, press **Menu 01-3** (Messages - Chat). After a brief pause, you're prompted to enter the recipient's phone number.
- 2 Enter the recipient's number or press **Find** to retrieve a number from the phone book, and press **OK**.
- 3 Enter your Chat name (up to 5 characters) and press **OK**.

Another way to start a chat: When you have received a message, press **Show** to read it. To start a chat, press **Options** and select **Chat**.

- 4 Enter your chat message using the keypad. For faster ways to write a message, see "Write with predictive text" on page 36.
- 5 When you're ready to send the message, press **Options**, scroll to **Send**,

and press **Select**.

- 6 When you receive a reply, the message from the other person is shown above your original message.
- 7 To reply to the message, press **OK** and repeat the steps 4 and 5.
- 8 To end the chat session, press **OK** and select **Quit**.
 - To view the latest messages of the current chat session, press **Options** and select **Chat history**. The message that you have sent is indicated by "<" and your nickname. The messages from your chat partner are indicated by ">" and that sender's nickname.
 - Press **Back** to return to the message you are writing. To edit your nickname, press **Options**, scroll to **Chat name** and press **Select**.

• VOICE MESSAGES

If you subscribe to voicemail, your wireless provider will furnish you with a voice mailbox number. You need to save this number to your phone to use voicemail. When you receive a voice message, your phone lets you know by beeping, displaying a message, or both. If you receive more than one message, your phone shows the number of messages received.

Save your voice mailbox number

Your wireless provider may have already saved your voice mailbox number to your phone. If so, the number will appear in the display in step 2. Press **OK** to leave the number unchanged.

- 1 At the Start screen, press **Menu 01-4-2** (Messages - Voice messages - Voice mailbox number).
- 2 After a brief pause, the **Voice mailbox number** screen appears in the display.
- 3 If the box is empty, enter the voice mailbox area code and number.
- 4 Press **OK**. Your phone confirms the number has been saved.



Tip: Save yourself the trouble of entering the mailbox codes each time you dial voicemail. See “Automate voicemail” later in this section for more information.

Call and setup your voicemail

- 1 Once you’ve saved the voice mailbox number, press and hold **1∞**.
- 2 When you connect to voicemail and the pre-recorded greeting begins, follow the service’s automated instructions to setup your voicemail.

Listen to your voice messages

Once you’ve setup voicemail, you can dial the number in one of 4 ways:

- Dial the number using the keypad
- Press and hold **1∞**
- Press **Listen** if there’s a notification message in the display
- Press **Menu 01-4-1** (Messages - Voice messages - Listen to voice messages). After a brief pause, your phone dials the voicemail number.

Once you connect and the pre-recorded greeting begins, follow the automated instructions to listen to your voice messages.

• AUTOMATE VOICEMAIL

You can insert special characters called “dialing codes” into phone numbers such as voicemail and then save the number to a 1-touch dialing location. Dialing codes instruct the receiving system to pause, wait, bypass, or accept the numbers that follow them in the dialing string.



Note: Each voicemail service can vary. The examples and steps that follow are for clarification. Check with your wireless provider if you have specific questions about your voicemail service.

Write down some information

- 1 Write down your voice mailbox number.
- 2 Call and check your voicemail as you normally would.

- 3 Write down your interaction with the recorded prompts step-by-step. Keep in mind that each voicemail service may vary. However, it should look something like this:

Dial 2145551212, pause 5 seconds, press 1, pause 2 seconds, press 1234, press pound key.



Important: Be precise, you'll need this information in "Setup voicemail with dialing codes" later in this section.

LEARN HOW TO INSERT DIALING CODES

Press ***+** repeatedly to cycle through dialing codes. Once the desired code appears in the display, pause briefly and the code is inserted into the dialing string.

For example, press ***+** four times to display the "w" (wait character). Pause briefly and the wait character is inserted into the dialing string. Available dialing codes are as follows:

Dialing codes

*	Bypasses a set of instructions
+	Precedes an international telephone number
p	Pauses for 2.5 seconds before sending any numbers that follow
w	Wait. Your phone waits for you to press  before it sends any numbers or codes that follow.

Setup voicemail with dialing codes

- 1 At the Start screen, press Names, scroll to 1-touch dialing, and press Select.
- 2 Scroll to an empty 1-touch dialing slot and press Assign.
- 3 Enter your voice mailbox number, including the area code.
- 4 Refer to the table entitled "dialing codes," and enter any codes as necessary using the information that you wrote down earlier.

For example, if you pause for 5 seconds after connecting to voicemail,

enter **p** twice *after* the voice mailbox number, such as 2145551212**pp**.

- 5 Enter any remaining pauses, PIN codes, and other information that allows you to listen to your messages, then press **OK**.
- 6 Enter a name (such as Voicemail) and press **OK**. A message appears in the display confirming your 1-touch dialing location has been saved.

Now, to dial and listen to your voicemail, just press and hold the assigned 1-touch dialing key at the Start screen. No other keypresses should be necessary to connect and listen to your messages.

• MESSAGE OPTIONS

Some or all of the options in the following table are available for text messages, picture messages, multimedia messages, and e-mail.

- 1 While viewing a text, picture, multimedia message, or e-mail press **Options**.
- 2 Scroll to highlight an option. Press **Select** to activate the option or enter its submenu.

Option	Function
Delete	Delete the message you're viewing
Reply	Reply to the message; you've the option to include the Original text in the reply, a template, or empty screen
Use detail	Extract numbers, e-mail addresses and website addresses from the current message
Forward	Forward the message to another recipient
Edit	Edit the message
Move	Move the message to a folder you specify
Rename	Rename the message before it's saved to a folder

Option	Function
Copy to Calendar	Copy text from the beginning of the message to your phone's calendar as a reminder note for the current day.
Message details	View the sender's name and phone number, the message center used, reception date and time.

• ORGANIZE MESSAGES WITH FOLDERS

Save messages to folders

You can save messages to an existing folder or to a folder that you've created.

- 1 Press **Menu 01-1-1** (Messages - Text message - Create message). After a brief pause, the message entry screen appears in the display.
- 2 Write your message and press **Options**.
- 3 Scroll to **Save message** and press **Select**.
- 4 Scroll to the **Archive**, **Templates**, or **My folders** (if you've created a folder of your own) and press **Select**. The message is saved.

View saved messages

- 1 At the Start screen, press **Menu 01-1** (Messages - Text messages).
- 2 After a brief pause, scroll to the folder containing the message you wish to view and press **Select**.
- 3 Once the folder opens, scroll to the message you wish to view and press **Select**.

Inbox folder

Messages are automatically stored in the inbox after they've been read or if you press **Back** when **Message received** appears on the Start screen.

Archive folder

Store messages that have been read in the **Archive** folder.

Templates folder

Pictures and pre-written templates are stored in the **Templates** folder. Pre-loaded templates can be edited/customized.

My folders

Keep your messages organized by creating custom folders and saving some of your messages there.

ADD A FOLDER OF YOUR OWN

- 1 At the Start screen, press **Menu 01-1-7** (Messages - Text messages - My folders). After a brief pause, the folder opens.
- 2 Press **Options**. Scroll to **Add folder** and press **Select**.
- 3 Enter a name for the new folder and press **OK**. The folder is added.

REMOVE A FOLDER

Only folders created in **My folders** can be deleted. The **Inbox**, **Outbox**, **Archive**, and **Template** folders are protected. When you delete a folder, all messages in the folder are also deleted.

- 1 At the Start screen, press **Menu 01-1-7** (Messages - Text messages - My folders). After a brief pause, the folder opens.
- 2 Any folders that you've created appear in the display. Scroll to the folder you wish to remove and press **Options**.
- 3 Scroll to **Delete folder** and press **Select**. You're asked to confirm the deletion.
- 4 Press **OK** to delete or **Back** to exit.

Move a message to a folder

- 1 While viewing the message, press **Options**.
- 2 Scroll to **Move** and press **Select**.
- 3 Scroll to the destination folder and press **Select**.

• DELETE MESSAGES

If your message memory is full and you have more messages waiting at the network,  blinks in on Start screen. You can do the following to create more space:

- Read some of the unread messages and then delete them
- Delete messages from some of your folders

Delete a single message

To delete a single message, you need to open it first.

- 1 Press **Menu 01-1** (Messages - Text messages). After a brief pause, a list of options appears in the display.
- 2 Scroll to the folder containing the message you wish to delete and press **Select**. A list of messages, if you have any, appears in the display.
- 3 Scroll to the message you wish to delete and press **Select**. The message opens.
- 4 Press **Options**, scroll to **Delete**, and press **Select**.
- 5 You're asked to confirm the erasure. Press **OK** to delete the message or **Back** to exit.

Delete all messages in a folder

- 1 At the Start screen, press **Menu 01-1-8** (Messages - Text messages - Delete messages). After a brief pause, a list of your folders appears in the display.
- 2 Scroll to the folder containing the messages you wish to delete and press **Select**. You're asked to confirm your erasure.

 **Important:** If you select **All messages**, it deletes any messages which have been read in *all* of the folders.

- 3 Press **OK** to empty the folder.

Change text, e-mail and picture message settings

- 1 At the Start screen, press Menu 01-6-1-1 (Messages - Message Settings - Text messages - Sending profile).
- 2 If more than one message profile set is supported by your SIM card, scroll to the set you wish to change and press Select.

Message Setting	Function
Message center number	Save the phone number of the message center, which is necessary for sending text messages; obtain this number is from your wireless provider
Default recipient number	For text messages, the default number used to send messages
Use GPRS	Set GPRS as the preferred method of sending text messages
Reply via same center	Allow the recipient of your message to send you a reply message via your message center (network service).
Messages sent as	Select the message type Text, E-mail, Page, or Fax
Message validity	Define how long the network attempts to send your messages before it gives up
E-mail server number	For e-mail messages, the default number used to send e-mail
Delivery reports	Request the network to send delivery reports on your messages
Rename sending profile	Change the name of the selected sending profile; the sending profile sets display only if your SIM card supports more than one set

OVERWRITE SETTINGS FOR TEXT, E-MAIL, AND PICTURE MESSAGES

When the message memory is full, your phone can't send or receive any new messages. However, you can set your phone to automatically replace old messages in the **Inbox** and **Outbox** folders when new ones arrive.

- 1 Press **Menu**, 01-6-1 (Messages - Message settings - Text messages). After a brief pause, a list of options appear in the display.
- 2 Scroll to **Overwriting in sent items** or **Overwriting in inbox** and press **Select**.
- 3 Scroll to **Allowed** and press **Select** to replace the old messages with new ones in the **Sent items** or **Inbox** folder, respectively.

Change multimedia message settings

- 1 At the Start screen, press **Menu** 01-6-2 (Messages - Message settings - Multimedia msgs.). After a brief pause, a list of options appears in the display.
- 2 Scroll to an option. Press **Select** to activate the option or to enter its submenu.

Message setting	Function
Save sent messages	Saves sent multimedia messages to the Sent items folder
Allow multimedia reception	Chooses Yes, No, or In home network for your multimedia service. In home network can't receive multimedia messages outside the home network
Incoming multimedia messages	Select Retrieve to receive multimedia messages, or Reject if you don't wish to receive multimedia messages
Allow advertisement	Allows you to enable or disable reception of automatic multimedia advertisements

RECEIVE MULTIMEDIA CONNECTION SETTINGS AS A TEXT MESSAGE

You may be able to receive multimedia connection settings as a text message from your wireless provider. For more information, contact your wireless provider.

SELECT A FONT SIZE

- 1 Press Menu 01-6-3-1 (Messages - Message settings - Other settings - Font size). After a brief pause, a list of choices appear in the display.
- 2 Scroll to **Small font** or **Large font** and press **Select**. A message appears in the display confirming your selection.

Use the info message service

With the info message network service, you can receive short text messages on various topics, such as weather and traffic conditions, from your wireless provider.

- 1 At the Start screen, press Menu 01-5 (Messages - Info messages). After a brief pause, the list of options in the following table appears in the display.
- 2 Scroll to an option. Press **Select** to activate the option or to enter its submenu.

Message setting	Function
Info service	Select On or Off to activate or deactivate the service
Topics	Options for selecting, adding, editing, and deleting info topics
Language	Select the language in which info messages are received. The language you select does not affect the language you select under the Phone settings menu
Info topics saved on SIM card	Select one or more info topics to save to your SIM card



Note: For more information on topics, contact your wireless provider.

Use service commands

Use the **Service commands** editor to enter and send service requests (also known as USSD commands) to your wireless provider. Contact your wireless provider for information about specific service commands.

- 1 At the Start screen, press **Menu 01-7** (Messages - Service commands).
- 2 Enter a service request, such as an activation command for a specific network service, and press **Send**.

Call log (Menu 2)

Call log stores information about the last 10 missed, 10 received, or 20 dialed calls. It also adds the total duration of all calls. When the number of calls exceed the maximum, the most recent call replaces the oldest. For Call log to work properly:



- Your wireless provider must support caller ID, and it must be enabled
- Your calls can't be blocked
- Your phone must be on and within the service area

• CALL LOG OPTIONS

Whether you are viewing missed, received, or dialed calls, each of the menu options will be the same. Please refer to the following table regarding menu options for these features.

Missed, received, and dialed call options

Call time	Display the date and time of the call
Send message	Send a message to the number
View number	Display the number
Edit number	Edit the number and associate a name with the number
Save	Enter a name for the number and save it to your Phone book
Add to name	Add the number to an existing entry in your Phone book, if the number is not associated with a name
Delete	Clear the number from memory
Call	Call the number

- **VIEW MISSED CALLS**

Missed calls are calls that were never answered. You can check for missed calls in two ways:



Note: The Missed calls feature does not function while your phone is off or outside of the service area.

- 1 If # missed call appears in the display, press List. The phone number appears in the display.
- 2 Press Options to display the options listed in the table on page 81.
- 3 Scroll to an option, press Select to activate the option or to enter its submenu.

OR

- 1 At the Start screen, press Menu 2-1 (Call log - Missed calls).
After a brief pause, a list of missed calls appears in the display (if any exist).
- 2 Scroll to a name or number and press Options to display the options listed in the table on page 81.
- 3 Scroll to an option, press Select to activate the option or to enter its submenu.

- **VIEW RECEIVED CALLS**

Received calls are calls that have been answered.

- 1 At the Start screen, press Menu 2-2 (Call log - Received calls).
After a brief pause, a list of received calls appears in the display (if any exist).
- 2 Scroll to a name or number and press Options to display the options listed in the table on page 81.
- 3 Scroll to an option, press Select to activate the option or enter its submenu.

- **VIEW DIALED NUMBERS**

You can view dialed numbers in one of two ways:

- 1 At the Start screen, press . Your most recently dialed numbers appear in the display.
OR
- 2 At the Start screen, press **Menu 2-3** (Call log - Dialed numbers). After a brief pause, your most recently dialed numbers appear in the display.
- 3 Scroll to a name or number and press **Options** to display the options listed in the table on page 81.
- 4 Scroll to an option, press **Select** to activate the option or enter its submenu.

Call times

You can receive up to five calls from the same number and view the time each call occurred. Your clock must be set for this feature to work accurately. See "Set the clock" on page 26 for instructions on setting your clock.

- 1 While viewing a missed or received call, press **Options**, scroll to **Call time**, and press **Select**.
- 2 The time that the last call occurred appears in the display.
- 3 Press  to view other call times from this number. Press **Back** to return to the options list.

- **CLEAR CALL LISTS**

To clear any missed, dialed, or received calls from your phone's memory:

- 1 At the Start screen, press **Menu 2-4** (Call log - Delete recent call lists).
After a brief pause, **All**, **Missed**, **Received** and **Dialed** appear in the display.
- 2 Scroll to the call type you'd like to clear and press **Select**.

- **VIEW CALL DURATION**

- 1 **Duration of last call.** At the Start screen, press **Menu 2-5-1** (Call log - Call timers - Duration of last call). The duration of your last call appears in the display.
- 2 **Duration of dialed calls.** At the Start screen, press **Menu 2-5-2** (Call log - Call timers - Duration of dialed calls). The duration of all dialed calls appears in the display.
- 3 **Duration of received calls.** At the Start screen, press **Menu 2-5-3** (Call log - Call timers - Duration of received calls). The duration of all received calls appears in the display.
- 4 **Duration of all calls.** At the Start screen, press **Menu 2-5-4** (Call log - Call timers - Duration of all calls). The duration of all calls (missed, dialed, and received) appears in the display.

Profiles (Menu 3)

Profiles define how your phone reacts when you receive a call or a message, how your keypad sounds when you press a key, and more. Ringing options, keypad tones, and other settings for each of the 5 available profiles can be left at their default setting, or customized to suit your needs. Select and customize the most suitable profile for your situation, such as when you are in a meeting or outdoors. The following profiles are available:



- Normal • Silent • Meeting • Outdoor • Pager



Note: Profiles are also available for accessories such as a headset and car kit. See “Accessory settings” on page 99 for more information about accessory profiles.

• SELECT A PROFILE

- 1 At the Start screen, press Menu 3 (Profiles).
After a brief pause, the list of profiles appears in the display.
- 2 Scroll through the available profiles and press Select once the profile of your choice is highlighted.
- 3 Scroll to Select and press Select.

• CUSTOMIZE A PROFILE

You can customize any of the profiles a variety of ways.

- 1 At the Start screen, press Menu 3 (Profiles).
After a brief pause, the list of profiles appears in the display.
- 2 Scroll to the profile you wish to customize and press Select.
- 3 Scroll to Customize and press Select.

- 4 Use the scroll keys to display each of the options in the following table. Once you arrive at the option you'd like to customize, press **Select**.

 **Note:** You cannot rename the **Normal** profile.

Custom profile options

Ringling options	Select the ringling tone style
Ringling tone	Select the ringling tone for incoming calls
Ringling volume	Set the volume of your ringling tone
Vibrating alert	Turn the vibrating alert on or off
Message alert tone	Select the tone for received messages
Keypad tones	Set the volume of your keypad tones (or turn them off)
Warning tones	Turn warning and confirmation tones on or off
Alert for	Define which caller groups the selected profile will accept or decline. See "Caller groups" on page 52 for more information.
Profile name	Rename the profile (up to 16 characters)

• SET A TIMED PROFILE

Timed profiles can be used to prevent missed calls. For example, suppose you attend an event that requires your phone be set to **Silent** before the event starts, but you forget to return it to **Normal** until long after the event. During this time, you've missed several calls because the ringling tone was silent. A timed profile can prevent this by automatically returning your phone to the default profile at a time you specify.

 **Note:** Timed profiles can be set up to 24 hours in advance.

- 1 At the Start screen, press **Menu 3** (Profiles).
After a brief pause, the list of profiles appears in the display.
- 2 Scroll to the profile you wish to activate and set for timed expiration, then press **Select**.
- 3 Scroll to **Timed** and press **Select**.
- 4 Enter the time for the profile to expire and press **OK**.
The profile you've set for expiration is now active and appears in the Start screen along with a small "clock" icon

Settings (Menu 4)



Set the clock

- 1 At the Start screen, press Menu 4-1-1 (Settings - Time and date settings - Clock).

After a brief pause, Show clock (or Hide clock)

Set the time, and Time format appear in the display with Show clock (or Hide clock) highlighted.

- 2 Scroll to Set the time and press Select.
- 3 Enter the time (in hh:mm format) and press OK.
- 4 Scroll to am or pm and press Select. The time is set.

Show/hide the clock

You have the option of displaying (or not displaying) the clock on the Start screen.

- 1 At the Start screen, press Menu 4-1-1 (Settings - Time and date settings - Clock).

After a brief pause, Show clock (or Hide clock) Set the time, and Time format appear in the display with Show clock (or Hide clock) highlighted.

- 2 Press Select.
 - If your clock was previously "hidden," (not shown on the display), it will now appear in the upper right corner of the Start screen.
 - If your clock was previously shown in the display, it will now be hidden from view.

Change the time format

You can set the time format for am/pm or 24 hour format (military time).

- 1 At the Start screen, press Menu 4-1-1 (Settings - Time and date settings - Clock).

After a brief pause, **Show clock** (or **Hide clock**) **Set the time**, and **Time format** appear in the display with **Show clock** (or **Hide clock**) highlighted.

- 2 Scroll to **Time format** and press **Select**.
- 3 Scroll to **24-hour** or **am/pm** and press **Select**. A message appears in the display confirming your selection.

Set the date

- 1 At the Start screen, press **Menu 4-1-2** (**Settings - Time and date settings - Date**). After a brief pause, a list of options appears in the display.
- 2 Scroll to **Set the date** and press **Select**.
- 3 Enter the date and press **OK**. The date is set.

Set or change the date format

- 1 At the Start screen, press **Menu 4-1-2** (**Settings - Time and date settings - Date**).
- 2 Scroll to **Date format** and press **Select**.
- 3 Scroll to the format of your choice and press **Select**.
- 4 Scroll to the **date separator** of your choice (period, slash, hyphen, or space) and press **Select**. A message appears in the display confirming your selection.

• CALL SETTINGS

Call forwarding

Call forwarding tells your network to redirect incoming calls to another number.



Note: Call forwarding is network-dependent and may not work the same in all networks. Contact your wireless provider for availability.

ACTIVATE CALL FORWARDING



Note: This is a network dependent feature. All options listed in the following table may not appear in the display. Contact your wireless provider for more information.

- 1 At the Start screen, press **Menu 4-2-1** (Settings - Call settings - Call forwarding).
- 2 After a brief pause, the forwarding options listed in the following table appear in the display.

Forward all voice calls	Forward all calls to the number you specify
Forward if busy	Forward incoming calls when you're in a call
Forward if not answered	Forward incoming calls to another number if you're unable to answer. You can also set a delay before forwarding takes place
Forward if out of reach	Forward incoming calls when your phone is off reach
Forward when not able to take calls	Forward calls that aren't picked up. You can also set a delay before forwarding takes place
Forward all fax calls	Forward all fax calls to a fax mailbox
Forward all data calls	Forward all data calls to a data mailbox
Cancel all call forwarding	Cancel any call forwarding options you may have set

- 3 Scroll to the option of your choice and press **Select**.
- 4 Scroll to **Activate** and press **Select**.
- 5 Scroll to the destination to which your calls will be forwarded (such as **To other no.**) and press **Select**.
- 6 Enter the number to which your calls, data, or other information will be forwarded and press **OK**.

Your phone calls the network to activate the feature you've requested. The network sends a confirmation note when the feature has been activated successfully.



CANCEL CALL FORWARDING

- At the Start screen, press **Menu 4-2-1-8** (Settings - Call settings - Call forwarding - Cancel all call forwarding).



Note: Cancel all call forwarding may affect your ability to receive voice mail messages. Contact your wireless provider for specific details.

Anykey answer

Anykey answer allows you to answer an incoming call by briefly pressing any key except the power key, , , and .

- 1 At the Start screen, press **Menu 4-2-2** (Settings - Call settings - Anykey answer). After a brief pause, **On** and **Off** appear in the display.
- 2 Scroll to your choice and press **Select**.

Automatic redial

Occasionally, your network may experience heavy traffic, resulting in a "fast" busy signal when you dial. With automatic redial activated, your phone redials the number up to 10 times, and notifies you once the network becomes available.

ACTIVATE OR DEACTIVATE AUTOMATIC REDIAL

- 1 At the Start screen, press **Menu 4-2-3** (Settings - Call settings - Automatic redial). After a brief pause, **On** and **Off** appear in the display.
- 2 Scroll to your choice and press **Select**.

1-touch dialing

You can assign any entry in your Phone book to keys **2^{abc}** through **9^{w^xz^x}**, and then dial those entries by pressing and holding the assigned key.

ASSIGN A KEY TO 1-TOUCH DIALING

- 1 At the Start screen, press **Names**, scroll to **1-touch dialing** and press **Select**.

- 2 Scroll to any empty slot and press **Assign**.
- 3 Enter the number (including the area code) and press **OK**, or press **Find** to retrieve a number from your Phone book.
- 4 Enter a name for the number and press **OK**.

MAKE A CALL WITH 1-TOUCH DIALING

- *Press and hold* the key to which an entry has been assigned.
OR
- Press the key to which an entry has been assigned and then press .



Call waiting

If supported by your wireless provider, call waiting notifies you of an incoming call even while you're in a call. You can then accept, reject, or ignore the incoming call.

ACTIVATE CALL WAITING

- 1 Press **Menu**, scroll to **Settings**, and press **Select**.
- 2 Scroll to **Call settings** and press **Select**.
- 3 Scroll to **Call waiting** and press **Select**.
- 4 Scroll to **Activate** and press **Select**.

USE CALL WAITING

- During a call, press  to answer the waiting call. The first call is put on hold.
- Press  to end the active call.

Activate/deactivate summary after call

Your phone can display the time spent on a call when you hang up.

TURN ON SUMMARY AFTER CALL

- 1 At the Start screen, press **Menu 4-2-6** (Settings - Call settings - Summary after call).
After a brief pause, **On** and **Off** appear in the display.
- 2 Scroll to **On** and press **Select**.

TURN OFF SUMMARY AFTER CALL

- 1 At the Start screen, press Menu 4-2-6 (Settings - Call settings - Summary after call).

After a brief pause, On and Off appear in the display.

- 2 Scroll to Off and press Select.

Send my caller identity with next call

You can prevent your number from being displayed on the receiving party's caller ID. This feature is network dependent and works on a call-by-call basis. Contact your wireless provider for more information.

- 1 At the Start screen, press Menu 4-2-7 (Settings - Call settings - Send my caller identity). After a brief pause, Default, Yes, and No appear in the display.
- 2 Scroll to the selection of your choice and press Select. A message appears in the display confirming your selection.

Select a line for outgoing calls



Note: This is a network dependent feature. Check with your wireless provider for availability and a description of the feature.

- 1 At the Start screen, press Menu 4-2-8 (Settings - Call settings - Line for outgoing calls). After a brief pause, Line 1 and Line 2 appear in the display.



Important: If you select Line 2 and have not subscribed to this network service, you will not be able to place calls. However, calls on both lines can be answered regardless of the selected line.

- 2 Scroll to Line 1 or Line 2 and press Select. A message appears in the display confirming your selection.



Tip: If supported by your SIM card, you can prevent the line selection by using the Lock option.

• PHONE SETTINGS

Set the display language

- 1 At the Start screen, press **Menu 4-3-1** (Settings - Phone settings - Language).

After a brief pause, **Automatic**, **English**, **Português**, **Español**, and **Français** appear in the display.

- 2 Scroll to the language of your choice and press **Select**.



Note: The Language setting affects the time and date formats of the Clock, Alarm clock, and Calendar.

ACTIVATE OR DEACTIVATE AUTOMATIC KEYGUARD



Important: When keyguard is on, it may be possible to dial emergency numbers (for example, 911 or other official emergency numbers). Key in the emergency number and press . The number is displayed only after you have keyed in its last digit.

You can set the keypad of your phone to lock automatically after a preset time delay (from 10 seconds to 60 minutes). When the preset delay expires, the keypad locks automatically.

- 1 At the Start screen, press **Menu 4-3-2** (Settings - Phone settings - Automatic keyguard). After a brief pause, **On** and **Off** appear in the display.
- 2 Scroll to **On** (or **Off** to deactivate) and press **Select**.
- 3 If you selected **On**, **Set delay** appears in the display.
- 4 Enter the delay (in minutes and seconds) and press **OK**.

Cell info display



Note: Cell info display is network-dependent and may not work the same in all networks. Contact your wireless provider for availability.

When this function is selected, your phone will indicate when it is used in a system cell based on Micro- Cellular Network technology. MCN technology increases the capacity of wireless networks in urban areas. The setting will remain in effect even if the SIM card is changed or the phone is switched off.

- 1 Press **Menu 4-3-3** (Settings - Phone settings - Cell info display). After a brief pause, **On** and **Off** appear in the display.
- 2 Scroll to **On** (or **Off**) and press **Select**. A message appears in the display confirming your selection.



Note: If the **GPRS** connection is set to **Always online**, info messages may not be received. In that case, set the **GPRS** connection to **When needed**, see “**GPRS**” on page 125 for more information.

Welcome note

You can write a welcome note which shows up briefly on your display whenever you power up your phone.



Note: Predictive text input is unavailable for entering Welcome note text.

- 1 At the Start screen, press **Menu 4-3-4** (Settings - Phone settings - Welcome note).
After a brief pause, the message edit screen appears in the display awaiting text input.
- 2 Enter a note (up to 44 characters).
 - Press ***+** to display and select from available special characters. For more information on special characters, “Enter punctuation and special characters” on page 35.
- 3 When you’re finished, press **Options**, scroll to **Save**, and press **Select**.
Scroll to **Delete** and press **Select** if you want to delete the previous text and begin writing another note.

System selection

You may be able to manually search for another network which has a roaming agreement with your home wireless provider.

- 1 At the Start screen, press Menu 4-3-5 (Settings - Phone settings - System selection). After a brief pause, **Automatic** and **Manual** appear in the display.
- 2 Scroll to **Automatic** or **Manual** and press **Select**.

Option	Function
Automatic	Your phone defaults to those settings which have been preset by your wireless provider
Manual	Your phone searches for a network which has a roaming agreement with your wireless provider



Note: If No system access appears in the display, you'll need to switch to **Automatic** mode, or insert another SIM card into the phone.

Confirm SIM service actions

This option allows you to request notification when your service provider makes changes to SIM-related services (such as activating GPRS service).

- 1 Press Menu 4-3-6 (Settings - Phone settings - Confirm SIM service actions). After a brief pause, **Yes** and **No** appear in the display.
- 2 Scroll to the selection of your choice and press **Select**. A message appears in the display confirming your selection.

Help text

Your phone displays brief descriptions for most menu items. When you arrive at a feature or menu, pause for about 10 seconds. Use the scroll keys to page through the full help text, if necessary.

ACTIVATE/DEACTIVATE HELP TEXT

The default setting for Help text is On. However, you can turn help text on or off by doing the following from the Start screen.

- 1 Press **Menu 4-3-7** (Settings - Phone settings - Help text activation). After a brief pause, **On** and **Off** appear in the display.
- 2 Scroll to your choice and press **Select**. A message appears in the display confirming your selection.

START-UP TONE

You can set your phone to play (or not to play) a start-up tone when the phone is switched on.



- 1 At the Start screen, press **Menu 4-3-8** (Settings - Phone settings - Start-up tone). After a brief pause, **On** and **Off** appear in the display.
- 2 Scroll to your choice and press **Select**. A message appears in the display confirming your selection.

• DISPLAY SETTINGS

Wallpaper

You can set your phone to display a background picture (wallpaper) on the Start screen. Some pictures are pre-saved in the **Gallery** menu. You can also receive pictures via multimedia message, download them from WAP pages or transfer them with PC Suite from your PC and then save them in the **Gallery**. Your phone supports JPEG, GIF, BMP, PNG, and WBMP formats.

SELECT WALLPAPER

- 1 Press **Menu 4-4-1** (Settings - Display settings - Wallpaper). After a brief pause, **On**, **Off**, and **Change image** appear in the display.
- 2 Scroll to **Change image** and press **Select** to browse the gallery for another image.
- 3 Use the scroll keys ( ) to browse the image gallery. When you arrive at the image of your choice, press **Options**, scroll to **Set as wallpaper**, and press **Select**.

- 4 If **Replace current wallpaper?** appears in the display, press **OK**. A message appears in the display confirming your selection.

ACTIVATE/DEACTIVATE WALLPAPER

- 1 Press **Menu 4-4-1** (Settings - Display settings - Wallpaper). After a brief pause, **On**, **Off**, and **Change image** appear in the display.
- 2 Scroll to **On** or **Off** and press **Select**.

Color schemes

You can change the color of some display components in your phone, such as indicators and signal bars.

- 1 At the Start screen, press **Menu 4-4-2** (Settings - Display settings - Color Schemes). After a brief pause, a list of color schemes appear in the display.
- 2 Scroll to the color scheme of your choice and press **Select**. A message appears in the display confirming your selection.

Screen saver

The screen saver is activated when no function of the phone is used after a preset period of time. Press any key to deactivate the screen saver. The screen saver is also deactivated when the phone is out of the network coverage area.

- 1 At the Start screen, press **Menu 4-4-3** (Settings - Display settings - Screen saver timeout). After a brief pause, **2 minutes**, **5 minutes**, and **Other** appear in the display.
- 2 Scroll to **2 minutes** or **5 minutes** and press **Select**.
- 3 If you want to set a custom time (up to 60 minutes), scroll to **Other** and press **Select**. Enter the custom time and press **OK**. A message appears in the display confirming your selection.

SCREEN SAVER TIMEOUT

You can set your phone to display a screen saver after a preset time or after a custom time (up to 60 minutes) of your choosing.

Display brightness

You can change the brightness of your phone's display.

- 1 Press Menu 4-4-5 (Settings - Display settings - Display brightness). After a brief pause, a bar chart appears in the display indicating the current brightness level.
- 2 Use the left and right scroll keys (↶ and ↷) or the side volume keys to adjust the contrast level to your preference.
- 3 Press OK to accept your settings.

• TONE SETTINGS

You can adjust the ringing volume, keypad tones, and more for the currently active profile. The same options are described in detail under "Customize a profile" on page 85.

Accessory settings

The **Accessory settings** menu is shown only if the phone is or has been connected to one of the compatible accessories such as the headset, car kit, or mobile inductive loopset.

- 1 At the Start screen, press Menu 4-6 (Settings - Accessory settings). The following options may be available:
- 2 Scroll to Headset, Handsfree or Loopset and press Select.

IF YOU SELECTED HEADSET

The following options are available. Scroll to the option of your choice and press Select to enter the option's submenu and modify its settings.

- **Default profile** - Choose the profile you wish to be automatically activated when a headset is connected
- **Automatic answer** - Calls are answered automatically after 1 ring when a headset is connected. Scroll to **On** or **Off** and press **Select**

IF YOU SELECTED HANDSFREE

The following options are available. Scroll to the option of your choice and press Select to enter the option's submenu and modify its settings.

- **Default profile** - Choose the profile you wish to be automatically activated when your phone is connected to a car kit.

- **Automatic answer** - Calls are answered automatically after 1 ring when a car kit is connected. Scroll to **On** or **Off** and press **Select**.
- **Lights** - Choose to keep the phone lights always on, or to shut off automatically after several seconds. Scroll to **On** or **Automatic** and press **Select**.

IF YOU SELECTED LOOPSET

The following options are available. Scroll to the option of your choice and press **Select** to enter the option's submenu and modify its settings.

- **Use loopset** - Enable use of the LPS-4 mobile inductive loopset. Scroll to **Yes** or **No** and press **Select**.
- **Default profile** - Choose the profile you wish to be automatically activated when a loopset is connected.
- **Automatic answer** - Calls are answered automatically after 1 ring when a loopset is connected. Scroll to **On** or **Off** and press **Select**.

Security settings

For information on PIN code request, Call restrictions, Fixed dialing, and other security features, see "Manage phone security" on page 38.

Restore factory settings

You can reset some of the menu settings to their original values.

- 1 At the Start screen, press **Menu 4-8** (Settings - Restore factory settings). After a brief pause, you're prompted to enter the security code.
- 2 Enter the security code (the default is 12345) and press **OK**. A message appears in the display confirming your original settings have been restored.



Note: Any data that you have entered, such as names and numbers in your Phone book will not be deleted.

Alarm clock (Menu 5)

The alarm clock is based on your phone's internal clock. It sounds an alert any time you specify and even works if the phone is off.



• SET AN ALARM

IF AN ALARM HAS NOT BEEN SET

- 1 At the Start screen, press Menu 5 (Alarm clock). After a brief pause, you're prompted to enter a time for the alarm.
- 2 Enter the time for the alarm in hh:mm format and press OK.
- 3 Scroll to am or pm and press Select. Alarm on appears briefly in the display and  appears on the Start screen.

IF AN ALARM HAS PREVIOUSLY BEEN SET

- 1 At the Start screen, press Menu 5 (Alarm clock). After a brief pause, On and Off appear in the display.
- 2 Scroll to On and press Select. You're prompted to set the alarm time.
- 3 Enter the time for the alarm in hh:mm format and press OK.
- 4 Scroll to am or pm and press Select. Alarm on appears briefly in the display and  appears on the Start screen.

When the alarm sounds

Your phone beeps, vibrates, and the display lights up. Stop and Snooze appear in the bottom of the display.

WITH THE PHONE ON

Press Stop to shut the alarm off.

OR

Press Snooze. The alarm stops for 10 minutes and Snoozing appears in the display.



Note: If you don't press a key, the alarms stops (snoozes) for 5 minutes, and then sounds again.

WITH THE PHONE OFF

- 1 The alarm sounds. If you press **Stop** the following appears in the display:

Switch the phone on?



Note: The phone will only power up if you select **Yes** when **Switch the phone on?** appears in the display.

- 2 Press **Yes** to power up the phone. Press **No** to keep it switched off.



Warning: *Do not* switch the phone on when wireless phone use is prohibited or when it may cause interference or danger.

• TURN OFF AN ALARM THAT HAS BEEN SET

- 1 At the Start screen, press **Menu 5** (Alarm clock). After a brief pause, **On** and **Off** appear in the display.
- 2 Scroll to **Off** and press **Select**. **Alarm off** appears briefly in the display.

Radio (Menu 6)



Note: Your phone must be switched on to use this function. Do not switch the phone on when wireless phone use is prohibited or when it may cause interference or danger.



To listen to the FM radio on your phone connect the HDS-3 stereo headset or HDB-4 boom headset to the connector on the bottom of the phone. The leads of the headset function as the antenna, so let it hang freely.



Note: The quality of the radio broadcast depends on the radio station's coverage in that particular area.



• TURN THE RADIO ON AND OFF

- At the Start screen, press Menu 6 (Radio).
- To quickly turn off the radio, press and hold .

• USE THE RADIO



Note: When you place or receive a call, the radio automatically mutes. Once the call is ended, the radio automatically switches back on.

- With the radio on, press Options to choose from the options listed in the following table. Press  or  to scroll to an option. Press Select to activate the option or enter its submenu.

Option	Function
Turn off	Turn off the radio
Save channel	Save the current station to one of 20 locations

Option	Function
Automatic tuning	Briefly press either scroll key to start the channel search up or down. Press OK when a channel is found.
Manual tuning	Press ▲ or ▼ to search in increments of 0.1 Mhz
Set frequency	Manually enter the frequency of a known radio station
Delete channel	Delete a saved channel
Loudspeaker	Listen to the radio through the speakerphone
Mono output/ Stereo output	Listen to the radio in monaural mode. If already in manual mode, Stereo output appears in the display



Tip: To quickly set the radio frequency, press *+ with the radio on.



Tip: To manually tune the radio, press #^ with the radio on.



Note: When an application using a GPRS connection is sending or receiving data, it may interfere with the radio.

• SAVE A RADIO CHANNEL

You can save a preset station to any one of 20 locations in memory, and then tune to that station by simply pressing ▲ or ▼ with the radio on.

- 1 With the radio on, press and hold ▲ or ▼ to start the channel search. Searching stops when a channel is found.
- 2 To save the channel, press **Options**, scroll to **Save channel**, and press **Select**.
- 3 Enter a name for the channel and press **OK**.
- 4 Next, scroll to an (empty) location to save the channel and press **Select**.





Tip: To quickly save an FM station to a memory location from 1 to 9, press and hold the corresponding number key while the radio is playing. Then, enter the name of the channel and press **OK**.

Gallery (Menu 7)

You can save pictures and ringing tones to folders in the gallery, or create folders of your own and save them there. You can download images and tones via MMS, WAP, or Nokia PC Suite.



 **Note:** This feature uses shared memory. Please see “Shared memory” on page 13 for more information.

 **Note:** Your phone must be switched on to use this function. Do not switch the phone on when wireless phone use is prohibited or when it may cause interference or danger.

• OPEN THE GALLERY

- At the Start screen, press Menu 7 (Gallery). After a brief pause, the submenus in the following table appear in the display.

Option	Function
View folders	Explore the folders in the gallery menu. See “View folders” in the following section for more info
Delete folder	Delete a folder you’ve created
Rename folder	Rename a folder you’ve created
Add folder	Add a folder of your own
^a Gallery downloads	Use the image and tone downloads in your phone; see the following for more information

- The phone tries to connect to the Internet using your WAP browser and the currently active set of gallery downloads. If the connection fails, you may need to activate another set or change the current settings. See “Set up for browsing” on page 129 for more information.

• VIEW FOLDERS

- 1 At the Start screen, press **Menu 7-1**(Gallery - View folders), and then press **Select**. A list of folders appear in the display.
- 2 Scroll to a folder, such as **Images** or **Tones** and press **Open**.
- 3 Scroll through the list of images or tones, and press **Options**. Press **Select** to activate the option or to enter its submenu.

Option	Function
Open/Play	Open the selected file; in the Tones folder, this option is named Play
Delete	Delete the selected file
Move	Move the file to another folder
Rename	Rename the selected file
Set as wallpaper/Set as ring tone	Set the graphic as wallpaper. In the Tones folder, this option is Set as ringing tone ; the tone is applied to profile in use
Details	View details of the file, such as the name, time and date the file was created
Sort	Sort the files according to date, type, name, or size

Organizer (Menu 8)

 **Note:** Your phone must be switched on to use this function. Do not switch the phone on when wireless phone use is prohibited or when it may cause interference or danger.

Your phone has many useful features for organizing your everyday life, including a calendar and a to-do list.



• CALENDAR

The calendar keeps track of reminders, calls you need to make, meetings, and birthdays. It can even sound an alarm for any of these events.

 **Note:** This feature uses shared memory. Please see "Shared memory" on page 13 for more information.

OPEN THE CALENDAR

At the Start screen, press Menu 8-1 (Organizer - Calendar). After a brief pause, the Monthly view appears in the display with the current date highlighted by a black box.

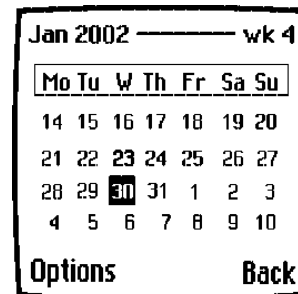





Monthly view





Tip: To quickly open the Calendar, press  at the Start screen.

USE FOUR-WAY SCROLLING

You can move the cursor in some calendar views using the , , , and  keys much the same as a joystick. To move the cursor:



Left, press 

Up, press 
Down, press 

Right, press 

- **MONTHLY VIEW**

Monthly view provides an overview of the selected month and weeks. It also allows you to jump to a specific date. Any days or dates that appear in bold font contain calendar notes such as a meeting or reminder.

- **GO TO A DATE**

- 1 Press **Menu 8-1** (Organizer - Calendar). After a brief pause, the monthly view appears in the display.
- 2 Press **Options**, scroll to **Go to date**, and press **Select**.
- 3 Enter the date (for example 12/15/2002) and press **OK**. The monthly view appears in the display with the "jump date" highlighted.

Make a note for a specific date

You can choose from five types of notes; **Meeting**, **Call**, **Birthday**, **Memo**, and **Reminder**. Your phone asks for further information depending on which note you choose. You also have the option to set an alarm for any note that you select.



Note: This feature uses shared memory. Please see "Shared memory" on page 13 for more information.

- 1 Go to the date for which you want to set a reminder. See "Go to a date" in the previous section if you need more information.
- 2 From the monthly view (with the go to date highlighted), press **Options**.
- 3 Scroll to **Make a note**, and press **Select**.
- 4 Scroll to one of the following note types and press **Select**



Meeting



Call



Birthday



Memo



Reminder

- 5 Enter your note, press **Options**, scroll to **Save**, and then press **Select**.
 - For a **Meeting** note, you're prompted to enter a subject, location, and then a start/end time. You're then given the option to set an alarm.

- For a **Call** note, you're prompted to enter a phone number, a name, and the time. You're then given the option to set an alarm.
- For a **Birthday** note, you're prompted to enter the person's name, and year of birth. You're then given the option to set an alarm.
- For a **Memo** note, you're prompted to enter a subject and then an end date. You're then given the option to set an alarm.
- For a **Reminder** note, you're prompted to enter the subject you wish to be reminded about, you're then given the option to set an alarm.

View calendar notes - the Day view

After you've created some calendar notes, you can view them as follows:

- 1 At the Start screen, press **Menu 8-1** (Organizer - Calendar).
After a brief pause, the monthly view appears in the display with the current date highlighted. Any dates that contain calendar notes will be in bold font.
- 2 Use four-way scrolling to go to the date containing the note.
- 3 Press **Options**, scroll to **View day**, and press **Select**. Any notes you have for the day will appear in a list format.
- 4 To view the body of a highlighted note, press **Options**, scroll to **View** and press **Select**.

Options while viewing a list of notes

- 1 Press **Options** while viewing a day's notes to display those options listed in the following table.
- 2 Scroll to an option. Press **Select** to activate the option or to enter its submenu.

Calendar note options

View	View the full note
Make a note	Make another note for the selected date
*Delete	Delete the note
*Edit	Edit the note

Calendar note options

*Move	Move the note to another date on your calendar
*Repeat	Enable the note to recur on a regular basis (daily, weekly, bi-weekly, monthly, and yearly)
Go to date	Jump to another date on your calendar
*Send note	Send the note to another device via Infrared or as a text message or in vCal format
*Copy	Copy the note. You can then “paste” the note to another date
*Settings	Set the date and time, date and time format, the day each week starts, and whether you want your notes to auto-delete after a specified time
Go to to-do list	Takes you to the to-do list for today's date

*Indicates an option that is available only while viewing the body of a note (not the header).

• SEND A CALENDAR NOTE TO ANOTHER DEVICE

Send a note via Infrared or text message



Note: If sending via IR (infrared), ensure the other device is set to receive data via IR. For more information on enabling the receiving device's IR, refer to the user guide for the receiving device.

- 1 At the Start screen, press **Menu 8-1** (Organizer - Calendar). After a brief pause, the monthly view appears in the display.
- 2 Jump, or scroll to the date containing the note you wish to send.



Tip: Any days containing notes will be in bold font.

- 3 Press **Options**, scroll to **View day**, and press **Select**.
- 4 Scroll to the note you wish to send and press **Options**.
- 5 Scroll to **Send note** and press **Select**.
- 6 Scroll to **Via Infrared**, **As note**, or **As text message**, and press **Select**.

- 7 If you selected **Via Infrared**, align the infrared ports of both devices and press **Select**. The note is sent.
- 8 If you selected **As note**, enter the number for the recipient (or press **Find** to retrieve a number from your Phone book), and press **OK**. The note is sent.
If you selected **As text message**, the note appears in the display.
- 9 Press **Options**, scroll to **Send**, and press **Select**.
- 10 Enter the number for the recipient (or press **Find** to retrieve a number from your Phone book), and press **OK**. The note is sent.

RECEIVE CALENDAR NOTES FROM ANOTHER DEVICE

When you receive a Calendar note, your phone displays **Calendar note received**. You can then save the note in your Calendar and set an alarm for any date and time.

VIEW RECEIVED CALENDAR NOTES

- 1 When your phone displays **Calendar note received**, press **Show**.
- 2 The text of your note appears in the display. Use the scroll keys to view the entire message, if necessary.

SAVE RECEIVED CALENDAR NOTES

- 1 After viewing the Calendar note, press **Options**.
- 2 Scroll to **Save** and press **Select**.

DISCARD VIEWED CALENDAR NOTES

- 1 After viewing the Calendar note, press **Options**.
- 2 Scroll to **Discard** and press **Select**.

• MAKE A TO-DO LIST



Note: This feature uses shared memory. Please see “Shared memory” on page 13 for more information.

You can keep track of your tasks with the to-do list feature. You may be able to save up to 30 notes, depending on their length.



Note: To-do notes are not related to specific dates.

Add a to-do note

- 1 At the Start screen, press **Menu 8-2** (Organizer - To-do list).
- 2 After a brief pause, press **Options**. If this is your first time to use the to-do list, **Add** is highlighted. You can also go to the Calendar.
- 3 Press **Select**, enter your to-do note and press **Options**.
- 4 Scroll to **Save** and press **Select**.
- 5 Scroll to **High, Medium, or Low** priority and press **Select**. The to-do note is saved.

Options while viewing notes

Press **Options** while viewing the header or body of a particular note and the following options appear in the display.

Header view	Option	Body view	Option
View	View the body of a note	Edit	Edit the content of a note
Add	Add another note	Set deadline	Set a deadline for the note
Delete	Delete the note	Mark note as done	Mark a note or task as complete; no more reminders will follow
Sort by deadline	Sort the notes according to their deadline	Delete	Delete the note
Send	Send the note as a text message	Edit priority	Change the priority to high, medium, or low
Go to calendar	Leave the to-do list and go to the calendar	Send	Send the note as a text message
Save to calendar	Save the to-do note to a date on your calendar	Go to calendar	Leave the to-do list and go to the calendar
N/A	N/A	Save to calendar	Save the to-do note to a date on your calendar

Games (Menu 9)



Note: Your phone must be switched on to use this function. Donot switch the phone on when wireless phone use is prohibited or when it may cause interference or danger.





- 1 At the Start screen, press Menu 9 (Games). After a brief pause, the list of game submenus in the following table appear in the display.
- 2 Scroll to a submenu. Press Select to enter the submenu and choose other settings.





Note: Some menus listed in the following table are network dependent. Contact your wireless provider for more information.

Submenu	Function
Select game	Select a game or enter a game's option list. See "Game options" on page 114 for more info on game options
Game downloads	Connect to game downloads on the Internet using your WAP browser
Memory	Check the available memory for games and game related applications
Settings	Turn game sounds, lights, and shakes on or off

• LAUNCH A GAME

- 1 Press Menu 9-1 (Games - Select game). After a brief pause, a list of games appears in the display.
- 2 Scroll to a game and press . If the selection is a single game it will launch. Otherwise, a list of games within the selected game set appears in the display. To launch a single game, scroll to the desired game and press .



Tip: If a game uses the whole display area, selection keys such as Options or Back will not appear in the display. Press  or  to show the options keys Select or Back (returns to the game).

Game options

- While viewing the games list, press Options to display those listed in the following table. Scroll to an option and press Select to activate the option or enter its submenu.

Option	Function
Open	Play the game
Delete	Delete the game
Web access	Options for restricting network access
Check version	Display the version of the highlighted game
Details	Display details of the game

Applications (Menu 10)



 The phone must be switched on to use this function. Do not switch on the phone when the use of a wireless phone is prohibited or when it may cause interference or danger.

With the **Applications** menu you can manage the Java™ applications installed on your phone, or those that may be offered by your wireless provider.



 **Note:** This feature uses shared memory. Please see “Shared memory” on page 13 for more information.

• LAUNCH AN APPLICATION

- 1 At the Start screen, press Menu 10-1 (Applications - Select application). After a brief pause, one or more applications appear in the display.
- 2 Scroll to an application or an application set and press **Options**, or press .
- 3 If the selection is a single application it will be launched. Otherwise, a list of applications in the selected application set is displayed.
 - To launch a single application within the set, scroll to the desired application and press **Options**, then press **Select** or .

• APPLICATION OPTIONS

Option	Function
Open	Opens the selected application or application set
Delete	Delete the application or application set from your phone.
Web access	Provides options for restricting network access Ask first (ask for net access) Allowed (allow net access) Not allowed (to not allow net access)
Check version	Check if a new version of the application is available for download
Web page	Provides further information or data for the application from an Internet page; this feature is network dependent and only appears if an Internet address has been provided with the application
Details	Shows additional information about the application

• DOWNLOAD APPLICATIONS

You can download new Java™ applications in different ways.

Use Application downloads

- 1 At the Start screen, press **Menu 10-2** (Applications - App. downloads). After a brief pause, the list of available WAP bookmarks appears in the display.



Note: This feature is network dependent. Contact your wireless provider for more information.

- Scroll to **More bookmarks** (if necessary) and press **Select** to access the list of WAP bookmarks in your **Services** menu.
- 2 Scroll to the appropriate bookmark that contains the application you wish to download, and press **Select** to connect to the WAP page. See

“Navigate the wireless Internet” on page 130 for information on browsing WAP pages.

Use the Game downloads menu

- At the Start screen, press Menu 9-2 (Games - Game downloads). After a brief pause, your phone connects to the WAP pages using the currently active set of WAP settings.



Note: If the connection fails, you may enter the Services menu and activate another set of service settings. See “Use browser options” on page 130 for more info on browser settings.

Use PC Suite

Use the Java™ Application installer from PC Suite to download the applications in your phone.



Note: Nokia does not warrant for applications from non-Nokia sites. If you choose to download Java applications from non-Nokia sites, take precautions for security or content.



Note: When you download a game or an application, it may be saved in the Games menu instead of the Applications menu.

Memory status for applications

You can view the size of memory available for game and application installations.

- At the Start screen, press Menu 10-3 (Applications - Memory). After a brief pause, the amount of free memory appears in the display.

Extras (Menu 11)

 **Note:** Your phone must be switched on to use this function. Do not switch the phone on when wireless phone use is prohibited or when it may cause interference or danger.



• USE THE CALCULATOR

The calculator in your phone adds, subtracts, multiplies, divides, counts the square and the square root and converts currency values.

 **Note:** Your phone must be switched on to use this function. Do not switch the phone on when wireless phone use is prohibited or when it may cause interference or danger.

 **Note:** Calculator has a limited accuracy and rounding errors may occur, especially in long divisions.

- 1 Press **Menu 11-1** (Extras - Calculator). After a brief pause, the calculator screen appears in the display.
- 2 Enter the first number in the calculation Press **#♦** for a decimal point if necessary.
- 3 Press ***+** to cycle through the add (+), subtract (-), multiply (*), and divide (/) characters. Pause briefly to select the currently displayed character.

 **Note:** To perform a square or square root calculation, press **Options**, scroll to **Square** or **Square root** and press **Select**.

- 4 Enter the second number in your calculation.
- 5 Press **Options**. Equals is highlighted. Press **Select**. The sum of your calculation appears in the display.

• USE THE CURRENCY CONVERTER

You can convert foreign currency to domestic, or vice versa directly from the Start screen.

- 1 At the Start screen, enter a currency amount to convert.
- 2 Press **Options**, scroll to one of the following and press **Select**:

To home	Converts foreign currency to domestic currency
To foreign	Converts domestic currency to foreign currency

If you haven't done so already, you're prompted to enter the exchange rate.

- 3 Enter the exchange rate and press **OK**. Press **#**  to insert a decimal. The converted amount appears in the display.

Edit the exchange rate

- 1 At the Start screen, press **Menu 11-1** (Extras > Calculator). After a brief pause, the calculator screen appears in the display.
- 2 Press **Options** (Exchange rate is highlighted), then press **Select** and scroll to highlight or display one of the following options:

Foreign units in home units	Enter the number of home units it takes to make one unit of foreign currency
Home units in foreign units	Enter the number of foreign units it takes to make one unit of your home currency

- 3 Press **Select** to edit your choice.
- 4 Enter the exchange rate and press **OK**. The exchange rate is saved.

• USE THE COUNTDOWN TIMER

The countdown timer is like an egg-timer or the timer on your microwave oven. You can enter a specified time (up to 99 hours and 59 minutes), and when the time runs out, your phone sounds an alarm.



Note: Your phone must be switched on to use this function. Do not switch the phone on when wireless phone use is prohibited or when it may cause interference or danger.



Note: The countdown timer only works when the phone is on. Once you turn off your phone, the timer is no longer active.

Set the countdown timer

- 1 At the Start screen, press **Menu** 11-2 (Extras - Countdown timer).
- 2 After a brief pause, you're prompted to enter the time. Enter 2 digits for hours, 2 digits for minutes, then press **OK**.
- 3 Enter a note for the timer, then press **OK**. The timer begins running.

CHANGE THE TIME

After you've set the timer, you can change the time.

- 1 At the Start screen, press **Menu** 11-2 (Extras - Countdown timer).
After a brief pause, **Change time** and **Stop timer** appear in the display.
- 2 Scroll to **Change time** and press **Select**.
- 3 Enter the new time and press **OK**.
- 4 Leave the note as it was, or enter a new note and press **OK**. The timer begins running.

WHEN THE ALARM SOUNDS

When the time runs out, your phone sounds an alarm, displays the timer note, and flashes its lights.

- Press any key during the alarm to stop the timer.
- After 30 seconds the timer alert expires automatically.

STOP THE TIMER BEFORE THE ALARM SOUNDS

- 1 At the Start screen, press **Menu 11-2** (Extras - Countdown timer).
After a brief pause, **Change time** and **Stop timer** appear in the display.
- 2 Scroll to **Stop timer** and press **Select**. **Timer stopped** appears in the display.

• USE THE STOPWATCH



Your phone has a stopwatch that can be used to track time at sporting events or other occasions. The stopwatch displays time in hours, minutes, seconds and fractions of a second. 00:00:00:0



Note: Your phone must be switched on to use this function. Do not switch the phone on when wireless phone use is prohibited or when it may cause interference or danger.

Note about stopwatch operation

Using the stopwatch consumes the battery and the phone's operating time will be reduced. Be careful not to let it run in the background when performing other operations with your phone.

If you press  and return to the Start screen, the clock continues to run in the background and the  icon appears in the upper left corner of the screen.

To return to the Stopwatch screen, take the following steps:

- 1 Press **Menu 11-3** (Extras - Stopwatch). After a brief pause, a list of options appear in the display.
- 2 Scroll to **Continue** and press **Select**.
 - To stop the clock, press **Stop**.

Measure time

- 1 Press **Menu 11-3** (Extras - Stopwatch). After a brief pause, a list of options appear in the display.
- 2 Scroll to **Split timing** and press **Select**.

- 3 Press **Start** to begin split timing. The running time appears on the screen.

Measure split time

You can use the split time function for such things as a long distance race when you need to pace yourself.

- 1 Press **Menu 11-3** (Extras - Stopwatch). After a brief pause, a list of options appear in the display.
- 2 Scroll to **Split timing**, then press **Select**.
- 3 Press **Start**.
- 4 Take an intermediate time by pressing **Split**. The timer continues to run. The split time appears below the running time.

If you split the time more than once, the new measured time appears at the beginning of the list. You can scroll to see previous measured times.

Measure lap time

You can use the lap time function when you want to track how long it takes to complete each cycle or lap.

- 1 Press **Menu 11-3** (Extras - Stopwatch). After a brief pause, a list of options appear in the display.
- 2 Scroll to **Lap timing** and press **Select**.
- 3 Press **Start**. The running time appears on the screen.
- 4 Take a lap time by pressing **Lap**.

The clock stops, then starts immediately from zero. The lap time appears below the running time.

If you take more than 1 lap time, the new measured time appears at the beginning of the list. You can scroll to see previous measured times. When you press **Stop**, the total time appears at the top.

SAVE THE LAP TIME

- 1 While the clock is running, press **Stop**, then press **Options**.
- 2 Scroll to **Save** and press **Select**.

- 3 Enter a name for the measurement and press OK. If you don't enter a name, the total time is used as the default title for the lap time.

STOP THE LAP TIMER

Press **Stop** to end the lap timer.

Choose other stopwatch options

You can choose the following options when using the Stopwatch.

Choice	Function
Continue	Shows up when the Stopwatch is working in the background.
Show last time	Allows you to view the last measured time.
View times	Allows you to browse the saved times.
Delete times	Allows you to delete any saved times. You can delete the saved times one by one or all at once.

Note about stopwatch operation

Using the stopwatch consumes the battery and the phone's operating time will be reduced. Be careful not to let it run in the background when performing other operations with your phone.

If you press  and return to the Start screen, the clock continues to run in the background and the  icon appears in the upper left corner of the screen.

To return to the Stopwatch screen, take the following steps:

- 1 Press **Menu 11-3** (Extras - Stopwatch). After a brief pause, a list of options appear in the display.
- 2 Scroll to **Continue** and press **Select**.
 - To stop the clock, press **Stop**.

Connectivity (Menu 12)



Note: Your phone must be switched on to use this function. Do not switch the phone on when wireless phone use is prohibited or when it may cause interference or danger.



You can make a serial connection between your phone and a PC using the DKU-5 data cable, which is available for purchase as an accessory. Once you establish this connection, you can access phone information from your PC, or use your phone as a wireless modem. It may also be possible to make this same serial connection between your phone and an Infrared-equipped laptop or IR-equipped desktop PC using your phone's infrared port.

- **INFRARED**

You can set up the phone to receive data through its infrared (IR) port. To use an IR connection, transmission and reception must be to or from an infrared compatible phone or device. You can send or receive data such as business cards and calendar notes to or from a compatible phone or data device (such as a computer) via the IR port of your phone.



Important: Do not point the IR (infrared) beam at anyone's eye or allow it to interfere with other IR devices. This device is a Class 1 Laser product.

SEND AND RECEIVE DATA VIA IR

- Ensure that the IR ports of the sending and receiving devices are pointing at each other and that there are no obstructions between the devices. The preferable distance between the two devices in an infrared connection is from 3 inches to 3 feet.
- Activate IR in your phone by pressing **Menu 12-1** (Connectivity - Infrared) at the Start screen.
- The user of the other device should activate IR as well.

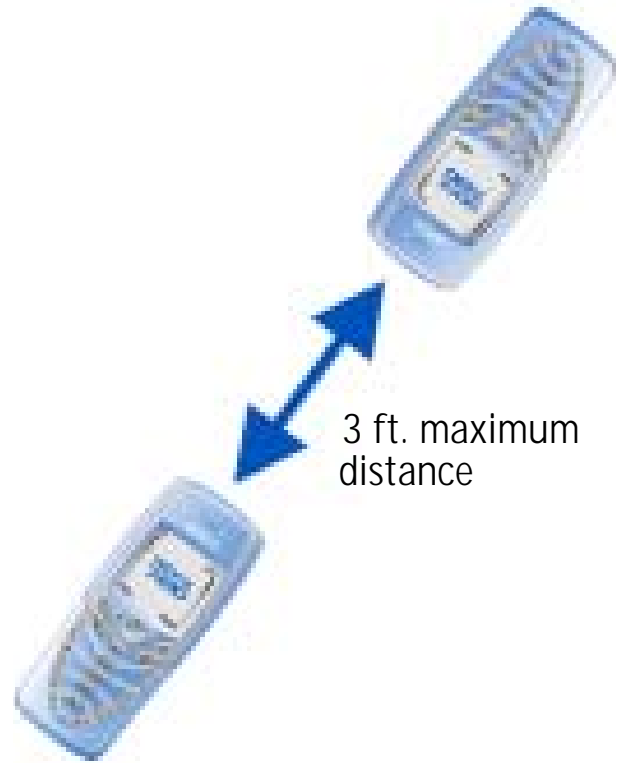

If data transfer is not started within two minutes after the activation of the IR port, the connection is cancelled and has to be started again.

IR CONNECTION INDICATOR

- When **Ⓜ** is shown continuously, the IR connection is activated and your phone is ready to send or receive data via its IR port.
- When **Ⓜ** blinks, your phone is trying to connect to the other device or a connection has been lost.

- **GPRS**

General Packet Radio Service (GPRS) is a technology used to send and receive data via short bursts or packets over the wireless network. With GPRS, you can stay connected to the Internet and allow for faster downloads without completing a dial-up connection. Applications using GPRS include the WAP browser, text messaging and dial-up connections for making digital data calls.

GPRS dial-up connections

When you use your Nokia phone as a wireless modem, you have the option of enabling GPRS connectivity from your PC or laptop computer.



Note: Before you can use GPRS for dial-up connections you must first subscribe to the GPRS network service. Contact your service provider for details on pricing and availability.

Some service providers may have already set up information for your GPRS dial-up connection.

For more information, see the PC/PDA connectivity guide. This document can be downloaded from the Nokia website at <http://www.nokia.com>.

Using data communication applications

For information on using a data communication application, refer to the documentation provided with the application.

If you use IR connection:

- Activate the IR connection in your phone by pressing Menu 12-1 (Connectivity - Infrared). Also, make sure that the connection is active in your PC.

If you use the DKU-5 data cable:

- 1 Connect the cable to the USB port on the back of your computer and to the connector on your phone.
- 2 Start using the data communications application on the computer.



Note: Making or answering phone calls during a computer connection is not recommended as it might disrupt the operation.

For better performance during data calls, place the phone on a stationary surface with the keypad facing downward. Do not move the phone by holding it in your hand during a data call.

• NOKIA PC SUITE

Once your phone is connected to your PC, you can use PC Suite to:

- Make a backup copy of the data in your phone (Content Copier)
- Edit Phone book names and numbers, profiles, and settings via your PC's keyboard (Phone Editor)
- Create ringing tones and transfer them to your phone (PC Composer)
- Create caller group icons or pictures for use with picture messaging (PC Graphics)
- Use the Nokia Image Converter to convert and optimize graphics for use in MMS messages or for creating wallpaper for your phone.
- Use the Nokia Sound Converter to convert General MIDI files for use with MMS messages and as ringing tones for your phone.
- Use the Nokia Phone Editor to edit your phone book and settings from your PC.
- Synchronize the Phone book and reminders with PIM applications such as Microsoft Outlook, Outlook Express, and Lotus Organizer (PC Sync)

Please refer to the *Nokia PC Suite Connectivity Guide* for installation and setup instructions.

• DOWNLOAD PC SUITE SOFTWARE

PC Suite software and documentation for the Nokia 7210 phone can be downloaded from the U.S. Mobile Phone products section of www.nokia.com/us.

Services (Menu 13)

Your phone has a built-in browser you can use to connect to selected services on the Internet. You can view weather reports, check news or flight times, view financial information, and much more.



 **Note:** This feature is network dependent. Contact your wireless provider for more information.

• NOTES ON WIRELESS INTERNET ACCESS

This section gives a brief overview of wireless Internet technology.

Technology background

WAP

A technology called Wireless Application Protocol (WAP) is to mobile devices what the World Wide Web (WWW) is to personal computers. The mobile community began developing WAP several years ago to provide access to the Internet for mobile users.

Today, most WAP sites are made up of text and hyperlinks. Some pages even contain low-resolution graphics, or require data input. Your service provider and others are free to design WAP sites as they choose, so the sites are as variable as Web pages on the Internet.

Internet content on your personal computer is called a “web page.” Internet content on your mobile phone is called a “page,” or “WAP card.”

The wireless provider's role

Because wireless Internet content is designed to be viewed from your phone, your wireless provider now becomes your “wireless Internet service provider” as well.

It's likely that your wireless provider has created a home page and set up your browser to go to this page when you log on to the Internet. Once at your service provider's home page, you may find links to a number of other sites.

- **SET UP FOR BROWSING**

It shouldn't be necessary to manually configure the browser on your phone. Normally this is done by your wireless provider once you've subscribed to the feature. Contact your wireless provider if you have problems using the browser.

- **SIGN ON TO THE WIRELESS INTERNET**

Use the **Services** menu to connect to the Internet.



Note: Your phone must be switched on to use this function. Do not switch the phone on when wireless phone use is prohibited or when it may cause interference or danger.

Press **Menu 13-1** (Services - Home). After a brief pause, your phone attempts to connect to your wireless provider's home page.

OR

At the Start screen, press and hold **0**.

Your phone connects to the Internet and to your service provider's home page.

If you see the message **Check service settings**, the phone may not be set up for browsing. Contact your wireless provider to make sure that your phone is configured properly.

- **USE BROWSER OPTIONS**



The **Services** menu gives you the options shown in the following table. Some wireless providers may have customized the options on the Services menu. Contact your wireless provider for more information if any of the options shown in the following table are not available.

Choice	What it does
Home	Starts the browser and takes you to your service provider's home page.
Bookmarks	Shows a list of all saved bookmarks. Bookmarks help you find a WAP site quickly.
Service inbox	Allows you to receive notifications from your service provider about new e-mail messages, changes in stock prices, and so on
Settings	Provides options for changing connection settings, appearance settings, and authority certificate.
Go to address	Accepts an address you enter.
Clear the cache	Empties the browser's temporary memory. It's advisable to empty the cache at the end of each session.

- **NAVIGATE THE WIRELESS INTERNET**

Since your phone's screen is much smaller than a computer screen, Internet content is displayed differently than you may be accustomed to seeing. This section contains guidelines for using phone keys to navigate a WAP site. Examples of how to read a WAP site follow the guidelines.

General guidelines for using the phone keys

- Use the scroll keys to browse the WAP site.  or .
- To select a highlighted item, press .
- To enter letters and numbers, press the keys **0**– through **9**^{wx}.
- To enter special characters, press the ***+** key.

Examples of wireless Internet sites

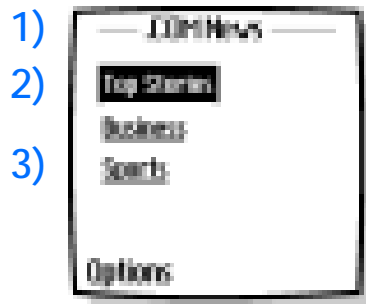

The following illustrations show most of the elements you may find on a wireless Internet site. These are examples only.



1) **Header line**: shows the current Internet site.

2) **Active link**: appears as a highlighted word.

3) **Inactive link**: appears as an underlined word.

Scroll through the list of links using  and .

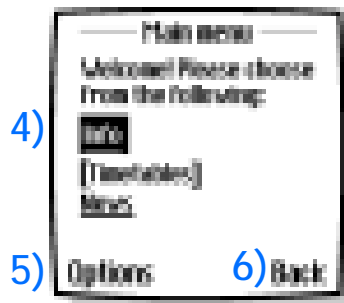

4) **Selection list**: Brackets [] appear when you have the option to enter information.

5) **Options**: Press **Options** to go to the site's menu and/or browser page.

6) **Back**: Press **Back** to return to the previous page.

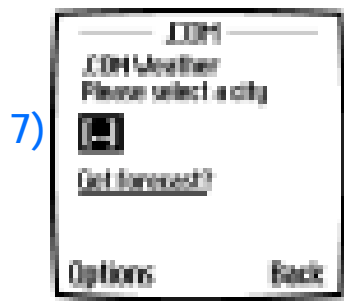

7) **Data entry field**: Brackets [] that enclose dots indicate when you need to enter information. In this example, you can enter your zip code to receive the local weather forecast.

• USE BOOKMARKS

You can save addresses for your favorite sites as bookmarks. A bookmark helps you find a site again, just as a slip of paper helps you find a page in a book. You can add up to 30 bookmarks to your browser.

Set a bookmark while browsing

- 1 Press **Menu** 13-2 (Services - Bookmarks). After a brief pause, a list of bookmarks (if any) appear in the display.
- 2 Press **Options**, scroll to **New bookmark** (if necessary), and press **Select**.
- 3 Enter an address for the bookmark and press **OK**.
- 4 Enter a title for the bookmark and press **OK**. A message appears in the display confirming your bookmark is saved.

Disconnect from the Internet

To close your connection, simply press  twice.

Security issues

BE SURE TO CLEAR THE CACHE MEMORY

The information or services you access with the WAP browser are temporarily saved in the cache memory of the phone. A cache is a buffer memory, which is used to store data temporarily.

If you tried to access or have accessed confidential information requiring passwords (for example, your bank account), empty the cache of your phone after each use.

CLEAR THE CACHE

- 1 Press **Menu** 13 (Services). After a brief pause, a list of options appear in the display.
- 2 Scroll to **Clear the cache** and press **Select**.

CLEAR THE CACHE WHILE BROWSING

- Press **Options**, scroll to **Clear the cache** and press **Select**.

About authority certificates

To use some WAP services, such as banking services, you need an authority certificate. Using the certificate can help you to improve the security of connections between your phone and a WAP server.

You can download the certificate from a WAP page if the WAP service supports the use of authority certificates. After the download, you can view the certificate, then save or delete it. If you save the certificate, it is added to the list of certificates in the phone.

Your phone alerts you if the identity of the WAP server or WAP gateway cannot be verified or is not authentic.

VIEW THE LIST OF AUTHORITY CERTIFICATES



- 1 Press **Menu 13-4** (Services - Settings). After a brief pause, a list of settings appears in the display.
- 2 Scroll to **Authority certificates** and press **Select**.

• GPRS ICONS

The following icons appear on the screen to show you the status of your GPRS connection.



Note: In order to use GPRS, you must first subscribe to the network service. Contact your service provider for details on availability and pricing.

G	Shows up in the upper left corner of the screen. Indicates an active GPRS connection, for example, when you are using the WAP browser.
	Indicates that circuit switched (CS) or voice calls are not possible when using GPRS.
	Indicates that the GPRS connection has been interrupted by a voice call.

Set up an automatic connection

Some service providers may have customized the options on the **Services** menu. Contact your service provider for more information if the options shown here are not available.





Important: GPRS may not be available in all wireless networks. The establishment and continuation of a GPRS and Internet connection depends on network availability, service provider support, and signal strength.

You can choose one of the following options for your GPRS connection.

- 1 At the Start screen, press **Menu 12-2-2** (Connectivity - GPRS - GPRS connection). After a brief pause, the following options appear in the display.
- 2 Scroll to an option and press **Select** to activate the option or to enter its submenu.
 - **Always online:** the phone is automatically registered to a GPRS network when you turn your phone on. When you use the WAP browser, the connection between your phone and the network is created and data transfer is possible. When you exit the WAP browser, the GPRS connection ends but the registration to the GPRS network remains.
 - **When needed:** the GPRS connection is established when you use the WAP browser and is closed when you exit the WAP browser.

Receive a call while online

If you are using the WAP browser over GPRS, you can still receive a voice call. Your data call is put on hold and you can choose to answer the call.

- To answer the incoming call, press .
- To reject the incoming call, press .



Note: After you end your voice call, the GPRS connection automatically resumes.



Make a call while online

When you are browsing a WAP card and want to make a call, you can select **Use number**. Your phone then searches the information on the WAP card for a string of numbers. You can then choose from the number or numbers displayed to place the call.

An alternate way is to press  to disconnect from the Internet, then place your call by searching the phone book for a name and number or by keying in the phone number.

Make an emergency call while online

If you are using GPRS to connect to the Internet, you can end your data connection and then make an emergency call.

- 1 To close your Internet connection, simply press .
- 2 Enter the emergency number for your present location (for example, 911 or any other official emergency number—emergency numbers vary by location).
- 3 Press .

9 Accessories

Standard 720 mAh Li-Ion Battery (BLD-3)

Provides up to 5 hours of talk time.
Provides up to 3 hours talk time with the speaker.
Provides up to 10 days of standby time.
Radio and headset up to 20 hours.
Radio and speaker up to 8 hours.

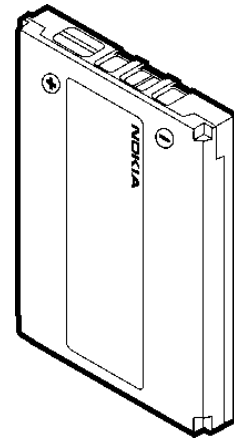

Note: Operation times are estimates and may vary depending on network conditions, charging and phone use.

Rapid Cigarette Lighter Charger (LCH-9)

Quickly charges the phone's battery from your vehicle.

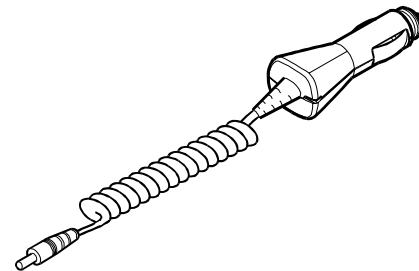

Rapid Travel Charger (ACP-12)

This lightweight AC charger can be used with all battery options. To use the charger, plug it into a standard 120V AC wall outlet, and connect the lead from the charger to the base of your phone. Calls can be made during charging, even with a fully discharged battery. The charger can also be used together with the optional Desktop Stand (DCV-14).

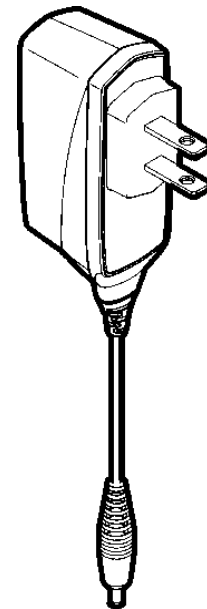

Boom Headset (HDB-4)

New over-the-ear design concept boom headset is small, lightweight, and provides excellent audio quality.



Stereo Headset (HDS-3)

Distinctive Nokia design enabling the use of stereo FM radio available on some Nokia phones. Provides excellent audio quality and handsfree functionality with an integral send/end button.

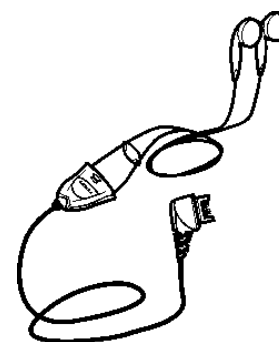

Loopset (LPS-4)

With the Nokia Loopset, people who use a T-coil equipped hearing aid have the freedom to talk on a digital mobile phone. The loopset goes around your neck - so it can be worn comfortably and discreetly.

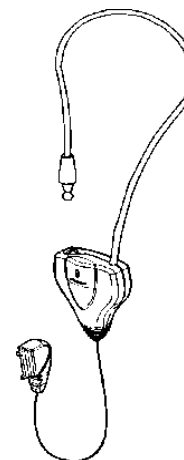

Data Cable (DKU-5)

For e-mail, faxes, Internet and data transmissions. Easy and convenient connection with no modem or PC card needed.

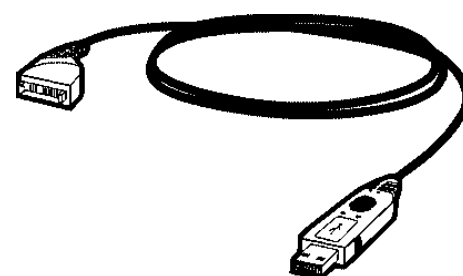

Complete Car Kit (CARK-143)

The full car kit is a complete handsfree solution for your vehicle.

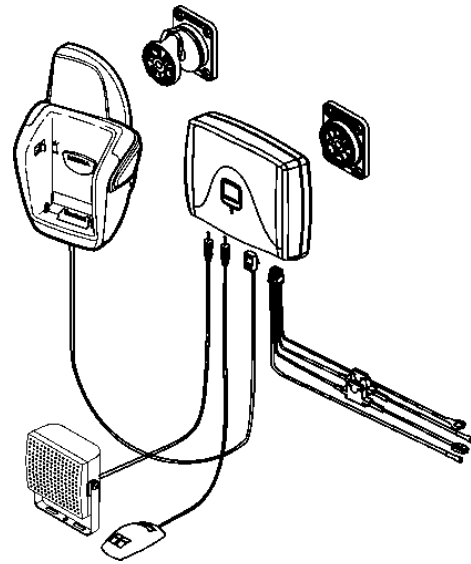

Xpress-on™ Color Covers

Express yourself with Xpress-on™ color covers that match your own unique style. Nokia 7210 color covers available in yellow, black, and red.

Leather carry case (CSL-32)

- Luxurious leather carry case
- Uses BCH-12P belt clip



Leather carry case (CSL-23)

- Luxurious, hard leather case with flap
- Integrated belt clip

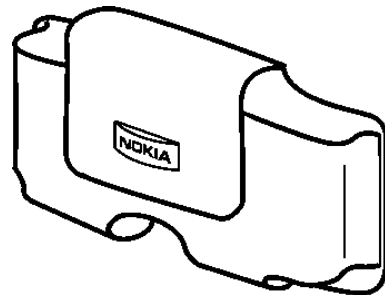

10 Reference information

This section provides information about your phone's batteries, accessories, chargers, safety guidelines and technical information. Be aware that the information in this section is subject to change as batteries, chargers, and accessories change.

• BATTERIES AND CHARGERS

This phone is intended for use when supplied with power from the ACP-12U and LCH-9 chargers. Other usage could invalidate any approval given to this apparatus and might be dangerous.



Warning: When you purchase batteries, chargers, and accessories for your phone, use only batteries, chargers, and accessories that have received approval from the phone's manufacturer. The use of any other type of phone-related hardware will invalidate any approval or warranty applying to the phone, and could also be dangerous. For availability of approved batteries, chargers, and accessories, check with your dealer.

- When the battery is fully charged, the indicator will tell you that the battery is fully charged.
- When you are not using a charger, disconnect it from the power source. Do not leave the battery connected to a charger for more than a week, since overcharging could shorten its lifespan. If left unused, a fully charged battery will discharge itself over time.

Temperature extremes can affect the ability of your battery to charge. Therefore, allow it to cool down or warm up before trying to charge it.

When the battery is running out of power and your phone only has a few minutes of talk time remaining, a warning tone sounds and the **Battery low** message appears briefly. When no more talk time is left, a warning tone is sounded and the phone switches off.

Do not short-circuit the battery. Accidental short-circuiting can occur when a metallic object, like a coin, a clip, or a pen causes a direct connection of the + and - terminals of the battery, which are metal strips on the end of the battery.

An example of short-circuiting could occur if you carry a spare battery in your pocket or purse, where the battery could come into contact with such objects as a coin. Short-circuiting could damage either the battery or the connecting object.

Leaving the battery in hot or cold places, such as in a closed car in either summer or winter conditions, will reduce the capacity and lifetime of the battery. Always try to keep the battery between 59° F and 77° F (15° C and 25° C).

A phone with a hot or cold battery might not work temporarily, even if the battery is fully charged. The performance of Li-Ion batteries is particularly limited in temperatures below 0° C (32° F).

The following list provides guidelines that you can follow:

- When the operating time (talk time and standby time) is noticeably shorter than normal, buy a new battery.
- Use the battery only for its intended purpose.
- Never use any charger or battery that is damaged and/or worn out.
- Batteries must be recycled or disposed of properly. Do not dispose of batteries by putting them in fire!
- When you disconnect the power cord of any accessory, grasp and pull the plug, not the cord.

• IMPORTANT SAFETY INFORMATION

Traffic safety

Do not use a wireless telephone while driving a vehicle. Always secure the phone in its holder; do not place the phone on the passenger seat or where it can break loose in a collision or sudden stop.

Remember road safety always comes first!

Operating environment

Remember to follow any special regulations and always switch off your phone wherever forbidden, or when it may cause interference or danger.

When connecting the phone or accessory to another device, read its user's guide for safety instructions. Don't connect incompatible products.

As with other mobile radio transmitting equipment, users are advised to operate this equipment only in the normal operating position (held to your ear with the antenna pointing over your shoulder).

Pacemakers

Pacemaker manufacturers recommend a distance of 20 cm (6 inches) be maintained between a hand-held wireless phone and a pacemaker to avoid interference with the pacemaker. These recommendations are consistent with independent research and recommendations of Wireless Technology Research.

PERSONS WITH A PACEMAKER:

- Should always keep the phone more than 20 cm (6 inches) from their pacemaker when the phone is switched on.
- Should not carry the phone in a breast pocket.
- Should use the ear opposite the pacemaker to minimize the potential for interference.
- Should switch off the phone immediately if there is any reason to suspect that interference is taking place.

Hearing aids

Some digital wireless phones may interfere with hearing aids. In the event of such interference, consult your wireless provider.

Other medical devices

Operation of any radio transmitting equipment, including cellular phones, may interfere with the functionality of inadequately protected medical devices. Consult a physician or the manufacturer of the medical device to determine if it is adequately shielded from external RF energy, or if you have any questions.

Switch off your phone in health care facilities when regulations posted in these areas instruct you to do so. Hospitals or health care facilities may be using equipment that could be sensitive to RF energy.

Electronic devices

Most modern electronic equipment is shielded from radio frequency (RF) signals. However, certain electronic equipment may not be shielded against the RF signals emanating from your wireless phone.

Posted facilities

Switch your phone off in any facility where posted notices so require.

Potentially explosive atmospheres

Switch off your phone when in any area with a potentially explosive atmosphere and obey all signs and instructions. Sparks in such areas could cause an explosion or fire resulting in bodily injury or even death.

Users are advised to switch off the phone when at a refuelling point (service station). Users are reminded of the need to observe restrictions regarding the use of radio equipment in fuel depots (fuel storage and distribution areas), chemical plants, or where blasting operations are in progress.

Areas with a potentially explosive atmosphere are often but not always clearly marked. They include below deck on boats, chemical transfer/storage facilities, vehicles using liquefied petroleum gas (such as propane

or butane), areas where the air contains chemicals or particles, such as grain, dust or metal powders, and any other area where you would be advised to turn off your vehicle engine.

Vehicles

Only qualified personnel should install or service the phone in a vehicle. Faulty installation or service may be dangerous and invalidate the warranty.

RF signals may affect improperly installed or inadequately shielded electronic systems in motor vehicles (for example, electronic fuel injection systems, electronic anti-skid (anti-lock) braking systems, electronic speed control systems, air bag systems).

Check with the manufacturer or its representative regarding your vehicle. You should also consult the manufacturer of any equipment that has been added to your vehicle.

Ensure all wireless phone equipment in your vehicle is mounted and operating properly.

Don't carry or store flammable liquids, gases or explosive materials in the same compartment as the phone or its accessories.

For vehicles equipped with an air bag, remember that an air bag inflates with great force. Don't place any objects in the area over the air bag or in the air bag deployment area. If in-vehicle wireless equipment is improperly installed and the air bag inflates, serious injury could result.

Aircraft

Switch off your phone before boarding an aircraft. The use of wireless telephones in an aircraft may be dangerous to the operation of the aircraft, disrupt the wireless telephone network, and may be illegal.

Failure to observe these instructions may lead to suspension or denial of telephone services to the offender, legal action, or both.

Emergency calls



Important: This phone, like any wireless phone, operates using radio signals and cannot be guaranteed to connect in all conditions. Therefore, you should never rely solely upon any wireless phone for essential communications (such as medical emergencies).

Remember, to make or receive any calls the phone must be switched on and in a service area with adequate signal strength. Emergency calls may not be possible on all wireless phone networks or when certain network services and/or phone features are in use. Check with local wireless providers for more information.

MAKING AN EMERGENCY CALL:

1 If the phone is not on, switch it on.



Important: Some networks may require that a valid SIM card be properly inserted in the phone.

2 Press and hold  to return to the Start screen.

3 Enter the emergency number for your present location (for example, 911 or other official emergency number). Emergency numbers vary by location.

4 Press .

If certain features are in use (Keyguard, fixed dialing, and so on), you may first need to turn those features off before you can make an emergency call. Consult this guide and your local wireless provider for more information.

When making an emergency call, remember to provide all information as accurately and clearly as possible. Remember that your wireless phone may be the only means of communication at the scene of an accident - don't cut off the call until given permission to do so.

Certification Information

THIS MODEL PHONE MEETS THE GOVERNMENT'S REQUIREMENTS FOR EXPOSURE TO RADIO WAVES.

Your wireless phone is a radio transmitter and receiver. It is designed and manufactured not to exceed the emission limits for exposure to radio frequency (RF) energy set by the Federal Communications Commission of the U.S. Government. These limits are part of comprehensive guidelines and establish permitted levels of RF energy for the general population. The guidelines are based on standards that were developed by independent scientific organizations through periodic and thorough evaluation of scientific studies. The standards include a substantial safety margin designed to assure the safety of all persons, regardless of age and health.

The exposure standard for wireless mobile phones employs a unit of measurement known as the Specific Absorption Rate, or SAR. The SAR limit set by the FCC is 1.6W/kg.* Tests for SAR are conducted using standard operating positions accepted by the FCC with the phone transmitting at its highest certified power level in all tested frequency bands. Although the SAR is determined at the highest certified power level, the actual SAR level of the phone while operating can be well below the maximum value. This is because the phone is designed to operate at multiple power levels so as to use only the power required to reach the network. In general, the closer you are to a wireless base station antenna, the lower the power output.

Before a phone model is available for sale to the public, it must be tested and certified to the FCC that it does not exceed the limit established by the government-adopted requirement for safe exposure. The tests are performed in positions and locations (for example, at the ear and worn on the body) as required by the FCC for each model. The highest SAR value for this model phone as reported to the FCC when tested for use at the ear is 0.45W/kg, and when worn on the body, as described in this user guide, is 1.06W/kg with CSL-23. (Body-worn measurements differ among phone models, depending upon available accessories and FCC requirements).

While there may be differences between the SAR levels of various phones and at various positions, they all meet the government requirement.

The FCC has granted an Equipment Authorization for this model phone with all reported SAR levels evaluated as in compliance with the FCC RF exposure guidelines. SAR information on this model phone is on file with the FCC and can be found under the Display Grant section of <http://www.fcc.gov/oet/fccid> after searching on FCC ID PYA NHL-4.

For body worn operation, this phone has been tested and meets the FCC RF exposure guidelines when used with the Nokia accessories supplied or designated for this product. When carrying the phone while it is on, place the phone in the specific carrying case that has been tested for compliance.

Use of other accessories may not ensure compliance with FCC RF exposure guidelines.

*In the United States and Canada, the SAR limit for mobile phones used by the public is 1.6 watts/kg (W/kg) averaged over one gram of tissue. The standard incorporates a substantial margin of safety to give additional protection for the public and to account for any variations in measurements. SAR values may vary depending on national reporting requirements and the network band. For SAR information in other regions please look under product information at <http://www.nokia.com>.

11 Care and maintenance

Your phone is a product of superior design and craftsmanship and should be treated with care. The suggestions below will help you to fulfill any warranty obligations and to enjoy this product for many years. When using your phone, battery, charger, or any accessory:

- Keep all parts and accessories out of small children's reach.
- Keep all parts and accessories dry. Precipitation, humidity, and liquids contain minerals that will corrode electronic circuits.
- Don't use or store parts or accessories in dusty, dirty areas. Moving parts can be damaged.
- Don't store parts or accessories in hot areas. High temperatures can shorten the life of electronic devices, damage batteries, and warp or melt certain plastics.
- Don't store parts or accessories in cold areas. When the phone warms up (to its normal temperature), moisture can form inside the phone, which may damage electronic circuit boards.
- Don't attempt to open. Non-expert handling could cause damage.
- Don't drop, knock or shake. Rough handling can break internal circuit boards.
- Don't use harsh chemicals, cleaning solvents, or strong detergents to clean parts or accessories. Wipe it with a soft cloth slightly dampened in a mild soap-and-water solution.
- Don't paint. Paint can clog moving parts and prevent proper operation.
- Use only the supplied or an approved replacement antenna. Unauthorized antennas, modifications or attachments could damage the phone and may violate regulations governing radio devices.
- If the phone, battery, charger, or any accessory is not working properly, take it to your nearest qualified service facility. The personnel there will assist you, and if necessary, arrange for service.

- **TROUBLESHOOTING**

The following table lists some common problems and their solutions.

Problem	Possible cause	Possible solution
My phone isn't charging	The charger and phone aren't properly connected	Securely connect the charger to the phone
	The charger is not properly plugged into the wall	Ensure the charger is plugged in correctly
My phone isn't making/receiving calls	The battery isn't charged	Charge the battery
	The signal strength is poor	If you are indoors, move toward a window
I can't listen to my voice messages	You don't have voicemail service	Call your wireless provider
	You haven't setup your voicemail service with your wireless provider	Call your wireless provider
	You haven't saved your voicemail number to your phone	See "Save your voice mailbox number" on page 70
	You've forgotten your password or are entering it incorrectly	Call your wireless provider
	The voicemail number you've saved to your phone is incorrect	Call your wireless provider
When I insert my SIM card into another phone, it's rejected	Fixed dialing is activated on your SIM card and the receiving phone doesn't support fixed dialing	Deactivate fixed dialing on the SIM

12 Frequently Asked Questions

This section lists answers to the most frequently asked questions. Some of the answers contain menu shortcuts. For a list of shortcuts, see “Menu shortcuts” on page 16.

Q. What is my security code?

A. The default security code is 12345. However, Nokia recommends that you change this code immediately. Certain features can be used only after the correct security code has been successfully entered.

Q. How do I lock and unlock the keypad?

A. Lock the keypad by pressing Menu *+. To unlock the keypad, press Unlock *+.

Q. How do I make the phone ring louder?

A. Press Menu 3 (Profiles), and scroll through the list of profiles until you find the one for which you want to set the ringing volume. Then press Select.

- Scroll to Customize and press Select.
- Scroll to Ringing volume and press Select.
- Scroll to the volume level of your preference and press Select.

Q. How do I change the ringing tone?

A. Press Menu 3 (Profiles) and scroll through the list of profiles until you find the one for which you want to set the ringing tone. Then press Select.

- Scroll to Customize and press Select.
- Scroll to Ringing tone, and then press Select.
- Scroll through the options. After you hear the tone you want to use, press Select.

Q. How do I store my voice mailbox number?

A. Press Menu 01-4-2 (Messages - Voice messages - Voice mailbox number). Enter your voice mailbox phone number, and press OK.

Q. How do I call my voice mailbox number (retrieve voice messages)?

A. When your phone alerts you to new voice messages, press Listen and follow the instructions on the phone. If you'd rather listen to your messages later, press Exit.

To listen to your voice messages at a later time, perform one of the following actions:

- Press and hold **1∞**.
- Press Menu 01-4-1 (Messages > Voice messages > Listen to voice messages). Follow the recorded voice prompts to listen to your messages.

Q. How do I redial the last-dialed number?

A. Press  twice.

Q. How do I assign a key to 1-touch dialing?

A. Press Names and scroll to 1-touch dialing.

Press Select.

Scroll to the first (empty) slot and press Assign.

Enter or retrieve the name/number you want to assign to the key and press OK. Repeat these steps as many times as necessary.

Q. How do I check the Phone book memory status?

A. Press Names, scroll to Settings, and press Select. Scroll to Memory status and press Select. Scroll to Phone or SIM card and press Select. The memory status for your selection appears in the display.

Q. How do I find my phone's Model number and IMEI number?

A. The model number and IMEI numbers are located on a label under the phone's battery. Turn your phone off, remove the back cover and then remove the battery from the phone.

Q. How do I clear my call timers?



Important: Clearing call timers cannot be undone.

A. Press Menu 2-5-5 (Call log - Call timers - Clear timers).
When the security code prompt appears, enter your security code and press OK.

13 Glossary

Business card	A business card is the same as an entry in the phone book. It may contain a name, phone number, and text entry. It can also be sent to other devices.
Call forwarding	A network services feature you use to forward incoming calls to another number.
Call lists	A list used to track numbers for incoming, outgoing, or missed calls.
Call log	A log that registers information about calls you make and receive.
Call timers	Timers used to track the amount of time you spend on calls.
Call waiting	A network services feature that enables your phone to beep while you are in the middle of a call. The beep lets you know that someone else is calling you.
International Mobile Equipment Identifier (IMEI)	The identification number that is assigned to the phone. This number is located under the battery.
In-call options	Features available for use while you are in a call.
Keyguard	Locks the keypad to prevent accidental key presses.
Keypad tones	The tone you hear when you press a key.
Menu	A list of choices you can make to change settings on your phone or use various phone features.

Predictive text	A method of entering information in your phone that uses a dictionary to predict, or guess, what you are writing.
Profile	A group of settings you can use to customize the way your phone works.
Quick save	A fast method for saving a number.
Ringling tone	The sound your phone makes when you receive a call. Ringling tones can be ringling sounds or short tunes.
Scroll bar	A bar that appears on the right side of the screen when you scroll through the main menus.
Start screen	Your phone's idle screen.
Voice mail	A network services feature that enables people who call and miss you to leave a voice message on your phone.
Warning tones	Sounds your phone makes during error conditions, during confirmations, when the battery is low, and when you need to recharge the battery.

14 Technical information

Feature	Specification
Weight	2.92 oz. (82.78 grams) with BLD-3 700 mAh Li-Ion Battery
Wireless networks	GSM 900, 1800, and 1900 networks
Size (volume)	4.1 cubic inches (67 cubic centimeters)
Frequency Range (Tx)	GSM 900: 880 - 915 Mhz GSM 1800: 1710 - 1785 Mhz GSM 1900: 1850 - 1910 Mhz
Frequency Range (Rx)	GSM 900: 925 - 960 Mhz GSM 1800: 1805 -1865 Mhz GSM 1900: 1930 - 1990 Mhz
Tx Output Power	2W (max)
Battery Voltage	3.6 v DC
Number of channels	299
Memory locations	Up to 300 in phone memory

15 Nokia One-Year Limited Warranty

Nokia Inc. ("Nokia") warrants that this cellular phone ("Product") is free from defects in material and workmanship that result in Product failure during normal usage, according to the following terms and conditions:

- 1 The limited warranty for the Product extends for ONE (1) year beginning on the date of the purchase of the Product. This one year period is extended by each whole day that the Product is out of your possession for repair under this warranty.
- 2 The limited warranty extends only to the original purchaser ("Consumer") of the Product and is not assignable or transferable to any subsequent purchaser/end- user.
- 3 The limited warranty extends only to Consumers who purchase the Product in the United States of America.
- 4 During the limited warranty period, Nokia will repair, or replace, at Nokia's sole option, any defective parts, or any parts that will not properly operate for their intended use with new or refurbished replacement items if such repair or replacement is needed because of product malfunction or failure during normal usage. No charge will be made to the Consumer for any such parts. Nokia will also pay for the labor charges incurred by Nokia in repairing or replacing the defective parts. The limited warranty does not cover defects in appearance, cosmetic, decorative or structural items, including framing, and any non-operative parts. Nokia's limit of liability under the limited warranty shall be the actual cash value of the Product at the time the Consumer returns the Product for repair, determined by the price paid by the Consumer for the Product less a reasonable amount for usage. Nokia shall not be liable for any other losses or damages. These remedies are the Consumer's exclusive remedies for breach of warranty.

- 5 Upon request from Nokia, the Consumer must prove the date of the original purchase of the Product by a dated bill of sale or dated itemized receipt.
- 6 The Consumer shall bear the cost of shipping the Product to Nokia in Melbourne, Florida. Nokia shall bear the cost of shipping the Product back to the Consumer after the completion of service under this limited warranty.
- 7 The Consumer shall have no coverage or benefits under this limited warranty if any of the following conditions are applicable:
 - a) The Product has been subjected to abnormal use, abnormal conditions, improper storage, exposure to moisture or dampness, unauthorized modifications, unauthorized connections, unauthorized repair, misuse, neglect, abuse, accident, alteration, improper installation, or other acts which are not the fault of Nokia, including damage caused by shipping.
 - b) The Product has been damaged from external causes such as collision with an object, or from fire, flooding, sand, dirt, windstorm, lightning, earthquake or damage from exposure to weather conditions, an Act of God, or battery leakage, theft, blown fuse, or improper use of any electrical source, damage caused by computer or Internet viruses, bugs, worms, Trojan Horses, cancelbots or damage caused by the connection to other products not recommended for interconnection by Nokia.
 - c) Nokia was not advised in writing by the Consumer of the alleged defect or malfunction of the Product within fourteen (14) days after the expiration of the applicable limited warranty period.
 - d) The Product serial number plate or the accessory data code has been removed, defaced or altered.
 - e) The defect or damage was caused by the defective function of the cellular system or by inadequate signal reception by the external antenna, or viruses or other software problems introduced into the Product.

- 8 Nokia does not warrant uninterrupted or error-free operation of the Product. If a problem develops during the limited warranty period, the Consumer shall take the following step-by-step procedure:
- a) The Consumer shall return the Product to the place of purchase for repair or replacement processing.
 - b) If "a" is not convenient because of distance (more than 50 miles) or for other good cause, the Consumer shall ship the Product prepaid and insured to:
Nokia Inc., Attn.: Repair Department
795 West Nasa Blvd.
Melbourne, FL 32901
 - c) The Consumer shall include a return address, daytime phone number and/or fax number, complete description of the problem, proof of purchase and service agreement (if applicable). Expenses related to removing the Product from an installation are not covered under this limited warranty.
 - d) The Consumer will be billed for any parts or labor charges not covered by this limited warranty. The Consumer will be responsible for any expenses related to reinstallation of the Product.
 - e) Nokia will repair the Product under the limited warranty within 30 days after receipt of the Product. If Nokia cannot perform repairs covered under this limited warranty within 30 days, or after a reasonable number of attempts to repair the same defect, Nokia at its option, will provide a replacement Product or refund the purchase price of the Product less a reasonable amount for usage. In some states the Consumer may have the right to a loaner if the repair of the Product takes more than ten (10) days. Please contact the Customer Service Center at Nokia at the telephone number listed at the end of this warranty if you need a loaner and the repair of the Product has taken or is estimated to take more than ten (10) days.

- f) If the Product is returned during the limited warranty period, but the problem with the Product is not covered under the terms and conditions of this limited warranty, the Consumer will be notified and given an estimate of the charges the Consumer must pay to have the Product repaired, with all shipping charges billed to the Consumer. If the estimate is refused, the Product will be returned freight collect. If the Product is returned after the expiration of the limited warranty period, Nokia's normal service policies shall apply and the Consumer will be responsible for all shipping charges.
- 9 YOU (THE CONSUMER) UNDERSTAND THAT THE PRODUCT MAY CONSIST OF REFURBISHED EQUIPMENT THAT CONTAINS USED COMPONENTS, SOME OF WHICH HAVE BEEN REPROCESSED. The used components comply with Product performance and reliability specifications.
- 10 ANY IMPLIED WARRANTY OF MERCHANTABILITY, OR FITNESS FOR A PARTICULAR PURPOSE OR USE, SHALL BE LIMITED TO THE DURATION OF THE FOREGOING LIMITED WRITTEN WARRANTY. OTHERWISE, THE FOREGOING LIMITED WARRANTY IS THE CONSUMER'S SOLE AND EXCLUSIVE REMEDY AND IS IN LIEU OF ALL OTHER WARRANTIES, EXPRESS OR IMPLIED. NOKIA SHALL NOT BE LIABLE FOR SPECIAL, INCIDENTAL, PUNITIVE OR CONSEQUENTIAL DAMAGES, INCLUDING BUT NOT LIMITED TO LOSS OF ANTICIPATED BENEFITS OR PROFITS, LOSS OF SAVINGS OR REVENUE, LOSS OF DATA, PUNITIVE DAMAGES, LOSS OF USE OF THE PRODUCT OR ANY ASSOCIATED EQUIPMENT, COST OF CAPITAL, COST OF ANY SUBSTITUTE EQUIPMENT OR FACILITIES, DOWNTIME, THE CLAIMS OF ANY THIRD PARTIES, INCLUDING CUSTOMERS, AND INJURY TO PROPERTY, RESULTING FROM THE PURCHASE OR USE OF THE PRODUCT OR ARISING FROM BREACH OF THE WARRANTY, BREACH OF CONTRACT, NEGLIGENCE, STRICT TORT, OR ANY OTHER LEGAL OR EQUITABLE THEORY, EVEN IF NOKIA KNEW OF THE LIKELIHOOD OF SUCH DAMAGES. NOKIA SHALL NOT BE LIABLE FOR DELAY IN RENDERING SERVICE UNDER THE LIMITED WARRANTY, OR LOSS OF USE DURING THE PERIOD THAT THE PRODUCT IS BEING REPAIRED.

- 11 Some states do not allow limitation of how long an implied warranty lasts, so the one year warranty limitation may not apply to you (the Consumer). Some states do not allow the exclusion or limitation of incidental and consequential damages, so certain of the above limitations or exclusions may not apply to you (the Consumer). This limited warranty gives the Consumer specific legal rights and the Consumer may also have other rights which vary from state to state.
- 12 Nokia neither assumes nor authorizes any authorized service center or any other person or entity to assume for it any other obligation or liability beyond that which is expressly provided for in this limited warranty including the provider or seller of any extended warranty or service agreement.
- 13 This is the entire warranty between the Nokia and the Consumer, and supersedes all prior and contemporaneous agreements or understandings, oral or written, relating to the Product, and no representation, promise or condition not contained herein shall modify these terms.
- 14 This limited warranty allocates the risk of failure of the Product between the Consumer and Nokia. The allocation is recognized by the Consumer and is reflected in the purchase price.
- 15 Any action or lawsuit for breach of warranty must be commenced within eighteen (18) months following purchase of the Product.
- 16 Questions concerning this limited warranty may be directed to:
Nokia Inc.
Attn.: Customer Service
7725 Woodland Center Blvd., Suite. 150
Tampa, FL 33614
Telephone: 1-888-NOKIA-2U (1-888-665-4228)
Facsimile: (813) 287-6612
TTY/TDD Users Only: 1-800-24-NOKIA (1-800-246-6452)
- 17 The limited warranty period for Nokia supplied attachments and accessories is specifically defined within their own warranty cards and packaging.

Appendix A

Message from the CTIA (Cellular Telecommunications & Internet Association) to all users of mobile phones.

© 2001 Cellular Telecommunications & Internet Association. All Rights Reserved. 1250 Connecticut Avenue, NW Suite 800, Washington, DC 20036.
Phone: (202) 785-0081

Safety is the most important call you will ever make.

A Guide to Safe and Responsible Wireless Phone Use

Tens of millions of people in the U.S. today take advantage of the unique combination of convenience, safety and value delivered by the wireless telephone. Quite simply, the wireless phone gives people the powerful ability to communicate by voice--almost anywhere, anytime--with the boss, with a client, with the kids, with emergency personnel or even with the police. Each year, Americans make billions of calls from their wireless phones, and the numbers are rapidly growing. But an important responsibility accompanies those benefits, one that every wireless phone user must uphold. When driving a car, driving is your first responsibility. A wireless phone can be an invaluable tool, but good judgment must be exercised at all times while driving a motor vehicle--whether on the phone or not.

The basic lessons are ones we all learned as teenagers. Driving requires alertness, caution and courtesy. It requires a heavy dose of basic common sense---keep your head up, keep your eyes on the road, check your mirrors frequently and watch out for other drivers. It requires obeying all traffic signs and signals and staying within the speed limit. It means using seatbelts and requiring other passengers to do the same.

But with wireless phone use, driving safely means a little more. This brochure is a call to wireless phone users everywhere to make safety their first priority when behind the wheel of a car. Wireless telecommunications is keeping us in touch, simplifying our lives, protecting us in emergencies and providing opportunities to help others in need.

When it comes to the use of wireless phones, *safety is your most important call.*

Wireless Phone "Safety Tips"

Below are safety tips to follow while driving and using a wireless phone which should be easy to remember.

- 1 Get to know your wireless phone and its features such as speed dial and redial. Carefully read your instruction manual and learn to take advantage of valuable features most phones offer, including automatic redial and memory. Also, work to memorize the phone keypad so you can use the speed dial function without taking your attention off the road.
- 2 When available, use a hands free device. A number of hands free wireless phone accessories are readily available today. Whether you choose an installed mounted device for your wireless phone or a speaker phone accessory, take advantage of these devices if available to you.
- 3 Position your wireless phone within easy reach. Make sure you place your wireless phone within easy reach and where you can grab it without removing your eyes from the road. If you get an incoming call at an inconvenient time, if possible, let your voice mail answer it for you.
- 4 Suspend conversations during hazardous driving conditions or situations. Let the person you are speaking with know you are driving; if necessary, suspend the

- call in heavy traffic or hazardous weather conditions. Rain, sleet, snow and ice can be hazardous, but so is heavy traffic. As a driver, your first responsibility is to pay attention to the road.
- 5 Do not take notes or look up phone numbers while driving. If you are reading an address book or business card, or writing a "to do" list while driving a car, you are not watching where you are going. It's common sense. Don't get caught in a dangerous situation because you are reading or writing and not paying attention to the road or nearby vehicles.
 - 6 Dial sensibly and assess the traffic; if possible, place calls when you are not moving or before pulling into traffic. Try to plan your calls before you begin your trip or attempt to coincide your calls with times you may be stopped at a stop sign, red light or otherwise stationary. But if you need to dial while driving, follow this simple tip--dial only a few numbers, check the road and your mirrors, then continue.
 - 7 Do not engage in stressful or emotional conversations that may be distracting. Stressful or emotional conversations and driving do not mix--they are distracting and even dangerous when you are behind the wheel of a car. Make people you are talking with aware you are driving and if necessary, suspend conversations which have the potential to divert your attention from the road.
 - 8 Use your wireless phone to call for help. Your wireless phone is one of the greatest tools you can own to protect yourself and your family in dangerous situations--with your phone at your side, help is only three numbers away. Dial 9-1-1 or other local emergency number in the case of fire, traffic accident, road hazard or medical emergency. Remember, it is a free call on your wireless phone!
 - 9 Use your wireless phone to help others in emergencies. Your wireless phone provides you a perfect opportunity to be a "Good Samaritan" in your community. If you see an auto accident, crime in progress or other serious emergency where lives are in danger, call 9-1-1 or other local emergency number, as you would want others to do for you.
 - 10 Call roadside assistance or a special wireless non-emergency assistance number when necessary. Certain situations you encounter while driving may require attention, but are not urgent enough to merit a call for emergency services. But you still can use your wireless phone to lend a hand. If you see a broken-down vehicle posing no serious hazard, a broken traffic signal, a minor traffic accident where no one appears injured or a vehicle you know to be stolen, call roadside assistance or other special non-emergency wireless number.

Careless, distracted individuals and people driving irresponsibly represent a hazard to everyone on the road. Since 1984, the Cellular Telecommunications Industry Association and the wireless industry have conducted educational outreach to inform wireless phone users of their responsibilities as safe drivers and good citizens. As we approach a new century, more and more of us will take advantage of the benefits of wireless telephones. And, as we take to the roads, we all have a responsibility to drive safely.

The wireless industry reminds you to use your phone safely when driving.

For more information, please call 1-888-901-SAFE.
For updates: <http://www.wow-com.com/consumer/issues/driving/articles.cfm?ID=85>

© 2001 Cellular Telecommunications & Internet Association. All Rights Reserved. 1250 Connecticut Avenue, NW Suite 800, Washington, DC 20036. Phone: (202) 785-0081

Appendix B

Message from the FDA (U.S. Food and Drug Administration) to all users of mobile phones.

July 18, 2001 For updates: <http://www.fda.gov/cdrh/phones>

Consumer Update on Wireless Phones

U.S. Food and Drug Administration

1. Do wireless phones pose a health hazard?

The available scientific evidence does not show that any health problems are associated with using wireless phones. There is no proof, however, that wireless phones are absolutely safe. Wireless phones emit low levels of radiofrequency energy (RF) in the microwave range while being used. They also emit very low levels of RF when in the stand-by mode. Whereas high levels of RF can produce health effects (by heating tissue), exposure to low level RF that does not produce heating effects causes no known adverse health effects. Many studies of low level RF exposures have not found any biological effects. Some studies have suggested that some biological effects may occur, but such findings have not been confirmed by additional research. In some cases, other researchers have had difficulty in reproducing those studies, or in determining the reasons for inconsistent results.

2. What is FDA's role concerning the safety of wireless phones?

Under the law, FDA does not review the safety of radiation-emitting consumer products such as wireless phones before they can be sold, as it does with new drugs or medical devices. However, the agency has authority to take action if wireless phones are shown to emit radiofrequency energy (RF) at a level that is hazardous to the user. In such a case, FDA could require the manufacturers of wireless phones to notify users of the health hazard and to repair, replace or recall the phones so that the hazard no longer exists.

Although the existing scientific data do not justify FDA regulatory actions, FDA has urged the wireless phone industry to take a number of steps, including the following:

- Support needed research into possible biological effects of RF of the type emitted by wireless phones;
- Design wireless phones in a way that minimizes any RF exposure to the user that is not necessary for device function; and
- Cooperate in providing users of wireless phones with the best possible information on possible effects of wireless phone use on human health.

FDA belongs to an interagency working group of the federal agencies that have responsibility for different aspects of RF safety to ensure coordinated efforts at the federal level. The following agencies belong to this working group:

- National Institute for Occupational Safety and Health
- Environmental Protection Agency
- Federal Communications Commission
- Occupational Safety and Health Administration
- National Telecommunications and Information Administration

The National Institutes of Health participates in some interagency working group activities, as well.

FDA shares regulatory responsibilities for wireless phones with the Federal Communications Commission (FCC). All phones that are sold in the United States must comply with FCC safety guidelines that limit RF exposure. FCC relies on FDA and other health agencies for safety questions about wireless phones. FCC also regulates the base stations that the wireless phone networks rely upon. While these base stations operate at higher power than do the wireless phones themselves, the RF exposures that people get from these base stations are typically thousands of times lower than those they can get from wireless phones. Base stations are thus not the subject of the safety questions discussed in this document.

3. What kinds of phones are the subject of this update?

The term wireless phone refers here to hand-held wireless phones with built-in antennas, often called cell mobile or PCS phones. These types of wireless phones can expose the user to measurable radiofrequency energy (RF) because of the short distance between the phone and the user's head. These RF exposures are limited by Federal Communications Commission safety guidelines that were developed with the advice of FDA and other federal health and safety agencies. When the phone is located at greater distances from the user, the exposure to RF is drastically lower because a person's RF exposure decreases rapidly with increasing distance from the source. The so-called cordless phones; which have a base unit connected to the telephone wiring in a house, typically operate at far lower power levels, and thus produce RF exposures far below the FCC safety limits.

4. What are the results of the research done already?

The research done thus far has produced conflicting results, and many studies have suffered from flaws in their research methods. Animal experiments investigating the effects of radiofrequency energy (RF) exposures characteristic of wireless phones have yielded conflicting results that often cannot be repeated in other laboratories. A few animal studies, however, have suggested that low levels of RF could accelerate the development of cancer in laboratory animals. However, many of the studies that showed increased tumor development used animals that had been genetically engineered or treated with cancer-causing chemicals so as to be pre-disposed to develop cancer in the absence of RF exposure. Other studies exposed the animals to RF for up to 22 hours per day. These conditions are not similar to the conditions under which people use wireless phones, so we don't know with certainty what the results of such studies mean for human health.

Three large epidemiology studies have been published since December 2000. Between them, the studies investigated any possible association between the use of wireless phones and primary brain cancer, glioma, meningioma, or acoustic neuroma, tumors of the brain or salivary gland, leukemia, or other cancers. None of the studies demonstrated the existence of any harmful health effects from wireless phone RF exposures. However, none of the studies can answer questions about long-term exposures, since the average period of phone use in these studies was around three years.

5. What research is needed to decide whether RF exposure from wireless phones poses a health risk?

A combination of laboratory studies and epidemiological studies of people actually using wireless phones would provide some of the data that are needed. Lifetime animal exposure studies could be completed in a few years. However, very large numbers of animals would be needed to provide reliable proof of a cancer promoting effect if one exists. Epidemiological studies can provide data that is directly applicable to human populations, but 10 or more years follow-up may be needed to provide answers about some health effects, such as cancer. This is because the interval between the time of exposure to a cancer-causing agent and the time tumors develop - if they do - may be many, many years. The interpretation of epidemiological studies is hampered by difficulties in measuring actual RF exposure during day-to-day use of wireless phones. Many factors affect this measurement, such as the angle at which the phone is held, or which model of phone is used.

6. What is FDA doing to find out more about the possible health effects of wireless phone RF?

FDA is working with the U.S. National Toxicology Program and with groups of investigators around the world to ensure that high priority animal studies are conducted to address important questions about the effects of exposure to radiofrequency energy (RF).

FDA has been a leading participant in the World Health Organization International Electromagnetic Fields (EMF) Project since its inception in 1996. An influential result of this work has been the development of a detailed agenda of research needs that has driven the establishment of new research programs around the world. The Project has also helped develop a series of public information documents on EMF issues.

FDA and the Cellular Telecommunications & Internet Association (CTIA) have a formal Cooperative Research and Development Agreement (CRADA) to do research on wireless phone safety. FDA provides the scientific oversight, obtaining input from experts in government, industry, and academic organizations. CTIA-funded research is conducted through contracts to independent investigators. The initial research will include both laboratory studies and studies of wireless phone users. The CRADA will also include a broad assessment of additional research needs in the context of the latest research developments around the world.

7. How can I find out how much radiofrequency energy exposure I can get by using my wireless phone?

All phones sold in the United States must comply with Federal Communications Commission (FCC) guidelines that limit radiofrequency energy (RF) exposures. FCC established these guidelines in consultation with FDA and the other federal health and safety agencies. The FCC limit for RF exposure from wireless telephones is set at a Specific Absorption Rate (SAR) of 1.6 watts per kilogram (1.6 W/kg). The FCC limit is consistent with the safety standards developed by the Institute of Electrical and Electronic Engineering (IEEE) and the National Council on Radiation Protection and Measurement. The exposure limit takes into consideration the body's ability to remove heat from the tissues that absorb energy from the wireless phone and is set well below levels known to have effects.

Manufacturers of wireless phones must report the RF exposure level for each model of phone to the FCC. The FCC website (<http://www.fcc.gov/oet/rfsafety>) gives directions for locating the FCC identification number on your phone so you can find your phone's RF exposure level in the online listing.

8. What has FDA done to measure the radiofrequency energy coming from wireless phones?

The Institute of Electrical and Electronic Engineers (IEEE) is developing a technical standard for measuring the radiofrequency energy (RF) exposure from wireless phones and other wireless handsets with the participation and leadership of FDA scientists and engineers. The standard, Recommended Practice for Determining the Spatial-Peak Specific Absorption Rate (SAR) in the Human Body Due to Wireless Communications Devices: Experimental Techniques, sets forth the first consistent test methodology for measuring the rate at which RF is deposited in the heads of wireless phone users. The test method uses a tissue-simulating model of the human head. Standardized SAR test methodology is expected to greatly improve the consistency of measurements made at different laboratories on the same phone. SAR is the measurement of the amount of energy absorbed in tissue, either by the whole body or a small part of the body. It is measured in watts/kg (or milliwatts/g) of matter. This measurement is used to determine whether a wireless phone complies with safety guidelines.

9. What steps can I take to reduce my exposure to radiofrequency energy from my wireless phone?

If there is a risk from these products--and at this point we do not know that there is--it is probably very small. But if you are concerned about avoiding even potential risks, you can take a few simple steps to minimize your exposure to radiofrequency energy (RF). Since time is a key factor in how much exposure a person receives, reducing the amount of time spent using a wireless phone will reduce RF exposure.

If you must conduct extended conversations by wireless phone every day, you could place more distance between your body and the source of the RF, since the exposure level drops off dramatically with distance. For example, you could use a headset and carry the wireless phone away from your body or use a wireless phone connected to a remote antenna.

Again, the scientific data do not demonstrate that wireless phones are harmful. But if you are concerned about the RF exposure from these products, you can use measures like those described above to reduce your RF exposure from wireless phone use.

10. What about children using wireless phones?

The scientific evidence does not show a danger to users of wireless phones, including children and teenagers. If you want to take steps to lower exposure to radiofrequency energy (RF), the measures described above would apply to children and teenagers using wireless phones. Reducing the time of wireless phone use and increasing the distance between the user and the RF source will reduce RF exposure. Some groups sponsored by other national governments have advised that children be discouraged from using wireless phones at all. For example, the government in the United Kingdom distributed leaflets containing such a recommendation in December 2000. They noted that no evidence exists that using a wireless phone causes brain tumors or other ill effects. Their recommendation to limit wireless phone use by children was strictly precautionary; it was not based on scientific evidence that any health hazard exists.

11. What about wireless phone interference with medical equipment?

Radiofrequency energy (RF) from wireless phones can interact with some electronic devices. For this reason, FDA helped develop a detailed test method to measure electromagnetic interference (EMI) of implanted cardiac pacemakers and defibrillators from wireless telephones. This test method is now part of a standard sponsored by the Association for the Advancement of Medical Instrumentation (AAMI). The final draft, a joint effort by FDA, medical device manufacturers, and many other groups, was completed in late 2000. This standard will allow manufacturers to ensure that cardiac pacemakers and defibrillators are safe from wireless phone EMI. FDA has tested hearing aids for interference from handheld wireless phones and helped develop a voluntary standard sponsored by the Institute of Electrical and Electronic Engineers (IEEE). This standard specifies test methods and performance requirements for hearing aids and wireless phones so that no interference occurs when a person uses a compatible phone and a accompanied hearing aid at the same time. This standard was approved by the IEEE in 2000.

FDA continues to monitor the use of wireless phones for possible interactions with other medical devices. Should harmful interference be found to occur, FDA will conduct testing to assess the interference and work to resolve the problem.

12. Where can I find additional information?

For additional information, please refer to the following resources:

- FDA web page on wireless phones
<http://www.fda.gov/cdrh/phones/index.html>
- Federal Communications Commission (FCC) RF Safety Program
<http://www.fcc.gov/oet/rfsafety>
- International Commission on Non-Ionizing Radiation Protection
<http://www.icnirp.de>
- World Health Organization (WHO) International EMF Project
<http://www.who.int/emf>
- National Radiological Protection Board (UK)
<http://www.nrpb.org.uk/>

July 18, 2001 For updates: <http://www.fda.gov/cdrh/phones>

Index

Numerics

1-touch dialing

- assign a key 50, 91
- change numbers 51
- erase numbers 51
- make a call 51, 92

A

accessories

- battery (BLB-3) 136
- cigarette lighter charger
(LCH-9) 136
- data cable (DLR-3P) 137
- loopset (LPS-1) 137
- mobile holder (MBC-1) ... 138

activate

- automatic redial 91
- call forwarding 90
- loopset 100

adding folders 75

alarm

- setting 101
- snooze 101
- turning off 102
- with phone off 102
- with phone on 101

alarm clock 101

antenna 141

- contact with 9
- proper position 141
- unauthorized use 147

authority certificates 133

automate voicemail 71

automatic redial 91

B

battery

- important information 139
- operating range 140
- operation times 154
- prolonging battery life 10
- temperature range 140

birthday note 108

bookmark

- set while browsing 132

bookmarks 132

browser

- use bookmarks 132

browser options 130

C

cache memory 132

calculator

- currency conversion 119

calendar

- 4-way scrolling 107
- birthday note 108
- call note 108
- date notes 108
- jump to date 108
- meeting note 108
- memo note 108
- monthly view 108
- note options 109
- note types 108
- opening 107
- saving notes 108
- uses 107
- view notes 109

view received notes	111	ringing options	86
call duration	84	ringing tone	86
viewing	84	ringing volume	86
call forwarding	89	security codes	41
activate	90	security levels	38
cancelling	91	time format	88
definition	89	charger	
call log		connecting	9
about	81	information	139
call duration	92	clear call lists	83
clear call lists	83	clock	
view call duration	84	alarm	101
view dialed calls	83	set the date	89
view missed calls	82	show/hide	88
view received calls	82	time format	88
call note	108	codes	
call waiting	92	access	41
caller groups		dialing	72
options	52	PIN	42
setup	53	PIN2	43
calls		PUK	43
forwarding	90	security	41
ignoring	15	setup voicemail with	72
redial last	15	compose a picture message	61
cancel call forwarding	91	connect to other devices	124
car charger	136	content copier (PC suite)	127
car kit	138	countdown timer	120
change		currency	
1-touch dialing numbers	51	converting	119
date format	89	exchange rate	119
keypad tones	86	to foreign	119
message alert tone	86	to home	119
PIN code	42	currency conversion	119
PIN2 code	43	customer care	
profile names	86	Canada	14

USA	14
customize	
display language	94
D	
data cable	137
data synchronization	127
date, setting	89
deactivate automatic redial .	91
definition of terms	154
dialed calls, viewing	83
dialing codes	
how to use	72
setup voicemail with	72
dictionary	
add new words	37, 57
in predictive text	37, 57
disconnect from wireless Inter-	
net	132
display language	94
download	
pictures	60
software	127
E	
e-mail	
receive and reply to	59
emergency call	
make while using GPRS ...	135
emergency calls	
placing	144
things to remember	144
with keypad locked	38, 94
erase	
1-touch dialing numbers ...	51
messages	76

F	
fixed dialing	
edit number list	40
emergency numbers	39
notes about	41
setup and activate	39
folders	
adding	75
list of	74
organize messages with	74
removing	75
four-way scrolling	
in calendar	107
G	
glossary	154
GPRS	
dial-up connections	126
make a call while online ...	135
phone symbols	133
receive a call while online .	134
I	
IMEI	
location on the phone	14, 152
Infrared connections	124
Internet	
connect with your phone ..	129
J	
jump to a date	108
L	
languages	
available	94
setting	94
loopset	

description	137	PC sync	127
M		PC sync	127
make an emergency call while		phone security	
online	135	security code	41
meeting note	108	security levels	38
memo note	108	picture messages	
messages		compose and send	61
erasing	76	downloading pictures for ...	60
forwarding	60	modifying	62
message center number ...	55	phone behavior when received	61
message icons	54	PIN 2 code	43
moving	75	PIN code	
reading	59	changing	42
replying to	59	definition of	42
save to folders	74	PIN code request	42
view saved	74	predictive text	
write and send	58	about	56
missed calls	82	activate and deactivate .	35, 56
Modem setup		add new words	37, 57
download	126	example of	56
moving messages	75	using	56
N		primary number	
Nokia PC suite	127	copying	49
Nokia website	126	profiles	
O		customizing	85
one-touch dialing	91	definition of	85
P		list of	85
PC composer	127	selecting	85
PC Suite	127	timed	86
download	126	PUK codes	43
PC suite	127	R	
instructions	127	read messages	59
PC composer	127	received calls	82
		reference information	

batteries and chargers 139
removing folders 75

S

safety

aircraft 143
emergency calls 144
hearing aids 142
important safety information .
141
operating environment . . . 141
other medical devices 142
pacemakers 141
potentially explosive atmo-
spheres 142
traffic 141

SAR

definition 145
limits 146

save

calendar notes 108

security

security code 41

security levels 38

sending

calendar notes 110
messages 58
picture messages 60

set the display language 94

setup

voicemail 71

show/hide clock 88

SIM card

emergency calls 144
if rejected 43
non-owner 38

PIN code 42
security levels 38
service numbers 51

software download 127

speed dialing 91

assign a key 50, 91
make a call 51, 92

stopwatch 121

measure lap time 122
measure split time 122
stop the clock 123

T

text messages

send calendar notes as 112
sending 58
writing with predictive text . 56

time format 88

timed profiles 86

troubleshooting 148

V

vibrating alert

turn on or off 86

view

calendar notes 109
call duration 84
clock on the Start screen . . . 88
dialed numbers 83
fixed dialing numbers 40
missed calls 82
monthly view, calendar . . . 108
picture messages 61
received calendar notes . . . 111
received calls 82
received messages 59
saved messages 74

special characters	58
voice messages	28, 71
voicemail	
automate	71
automating	71
call and setup	71
listen to voice messages	28, 71
setup	71
using dialing codes	72
W	
WAP	128
WAP browser	130
use phone keys	130
WAP page	
active link	131
enter information	131
examples	131
header line	132
warning tones	
turn on or off	86
wireless Internet	
clear the cache	132
security issues	132
sign off	132
sign on	129
wireless Internet site	
examples	131
how to read	131
write and send a message . . .	58
www.nokia.com	126