

## Declaration of Conformity

Hereby, Sharp Telecommunications of Europe Ltd,  
declares that this GX30 is in compliance with the essential  
requirements and other relevant provisions of Directive  
1999/5/EC.

A copy of the original declaration of conformity can be  
found at the following Internet address:

<http://www.sharp-mobile.com>

## **Introduction**

Congratulations and thank you for choosing the GX30.

### **About This User Guide**

This user guide is carefully designed to help you learn about your phone's features and operations quickly and effectively.

### **NOTICE**

- We strongly recommend that you keep separate permanent written records of all important data. Data may be lost or altered in virtually any electronic memory product under certain circumstances. Therefore, we assume no responsibility for data lost or otherwise rendered unusable, whether as a result of improper use, repairs, defects, battery replacement, use after the specified battery life has expired or any other cause.
- We assume no responsibility, directly or indirectly, for financial losses or claims from third parties resulting from the use of this product and any of its functions, such as stolen credit card numbers, the loss or alteration of stored data, etc.
- All company and/or product names are trademarks and/or registered trademarks of their respective holders.
- Screen layout illustrated in this user guide may differ from the actual one.  
The information described in this user guide is subject to change without notice.

- All the functions described in this user guide may not be supported in all networks.
- We assume no responsibility for downloaded contents, information, etc. from network.
- The CGS-LCD is a world advanced technology product, giving you fine picture quality. Occasionally, a few black or bright pixels may appear on the screen. Please note that this will not have any impact on any of the features or performance.

### **Copyright**

According to copyright laws, the reproduction, alteration and use of material which is protected by copyright (music, pictures, etc.) is only permitted for personal or private use. If the user is not in possession of more extensive copyright or has not received the explicit permission from the copyright owner to reproduce, alter or use a copy which has been made or modified in this way, this is considered to be a violation of the copyright laws and gives the copyright owner the right to claim for damages. For this reason, avoid the illegal use of material which is protected by copyright.

Windows is a registered trademark of Microsoft Corporation in the United States and/or other countries.

Powered by JBlend™ Copyright 1997-2003 Aplix Corporation. All rights reserved. JBlend and all JBlend-based trademarks and logos are trademarks or registered trademarks of Aplix Corporation in Japan and other countries.



Powered by Mascot Capsule®/Micro3D Edition™  
Mascot Capsule® is a registered trademark of HI Corporation  
©2002-2003 HI Corporation. All Rights Reserved.

Licensed by Inter Digital Technology Corporation under one or more of the following United States Patents and/or their domestic or foreign counterparts and other patents pending, including U.S. Patents: 4,675,863; 4,779,262; 4,785,450 & 4,811,420.

Licensed under U.S. Patent 4,558,302 and foreign counterparts.

T9 Text Input is licensed under one or more of the following: U.S. Pat. Nos. 5,818,437, 5,953,541, 5,187,480, 5,945,928, and 6,011,554; Australian Pat. No. 727539; Canadian Pat. No. 1,331,057; United Kingdom Pat. No. 2238414B; Hong Kong Standard Pat. No. HK0940329; Republic of Singapore Pat. No. 51383; Euro. Pat. No. 0 842 463 (96927260.8) DE/DK, FI, FR, IT, NL,PT,ES,SE,GB; Republic of Korea Pat. Nos. KR201211B1 and KR226206B1; and additional patents are pending worldwide.

SD logo  is a trademark.

Bluetooth is a trademark of the Bluetooth SIG, Inc.



The Bluetooth word mark and logos are owned by the Bluetooth SIG, Inc. and any use of such marks by Sharp is under license. Other trademarks and trade names are those of their respective owners.

**CP8 PATENT**

## 2 Introduction

## Useful Functions and Services of the Phone

Your phone offers you the following features:

- Built-in digital camera that can take pictures and record video clips.
  - Create and read SMS (Text Message).
  - MMS (Multimedia Messaging Service) can personalise your phone in various ways: you can send and receive multimedia messages with graphical images, photographs, sound or video clips attached.
  - WAP browser to help you access a variety of information on the mobile Internet.
  - Java™ applications. You can also download various kinds of applications from Vodafone via the mobile Internet.
  - Continuous grain silicon (CGS) colour LCD main display with images that are clearer and easier to view.
  - Colour external display enables you to quickly see who is calling and if you have any new messages.
  - Mobile light with large number of uses: as a camera flash, battery charge notification, incoming call indicator and a makeshift torch.
  - Melody editing function allows you to create original ringtones using up to 32 voices.
  - Voice recorder function allows you to record and play back your voice clips.
  - MP3 player that can play back MP3 sound files.
- Memory card slot that expands connectivity with a PC by using the memory card.
  - Bluetooth interface that establishes contact with other Bluetooth-enabled device (handsfree headset for Bluetooth or handsfree car kit for Bluetooth only).

## Table of Contents

<b>Introduction</b> .....	<b>1</b>	<b>Entering Characters</b> .....	<b>32</b>
Useful Functions and Services of the Phone .....	3	Changing the Input Languages .....	33
<b>Table of Contents</b> .....	<b>4</b>	Changing the Input Method .....	33
<b>Your Phone</b> .....	<b>7</b>	Using Text Templates .....	34
Optional Accessories .....	7	<b>Using the Menu</b> .....	<b>35</b>
<b>Getting Started</b> .....	<b>8</b>	List of Menu Functions .....	37
Inserting the SIM Card and the Battery .....	11	<b>Contacts List</b> .....	<b>38</b>
Charging the Battery .....	15	Displaying the Contacts List .....	38
Inserting the Memory Card .....	16	Selecting the Contacts List Memory .....	38
Removing the Memory Card .....	18	Add New Contact .....	39
Turning Your Phone On and Off .....	18	Finding a Name and Number .....	43
Display Indicators (Main Display) .....	19	Dialling Using Contacts List Entries .....	43
Display Indicators (External Display) .....	22	Editing Contacts List Entries .....	44
<b>Call Functions</b> .....	<b>24</b>	Deleting a Single Contacts List Entry .....	45
Making a Call .....	24	Deleting All Contacts List Entries .....	45
Speed Dialling .....	24	Viewing Groups .....	45
Redialling .....	25	Memory Status .....	48
Ending a Call .....	25	Speed Dial List .....	49
Answering a Call .....	26	Sending Messages .....	49
Incall Menu .....	27	Swapping Location Number of the Phone Number .....	50

<b>Camera</b> .....	<b>51</b>	Settings .....	112
Take Picture .....	51	Java™ Information .....	116
Record Video .....	59	<b>Applications</b> .....	<b>117</b>
<b>Messages</b> .....	<b>66</b>	SIM Application .....	117
Multimedia (MMS) .....	66	MP3 Player .....	117
Text (SMS) .....	77	Calendar .....	118
Cell Broadcasts .....	84	Alarms .....	121
Area Info .....	86	Calculator .....	124
<b>Vodafone live!</b> .....	<b>87</b>	Voice Recorder .....	125
Viewing the WAP Browser .....	87	Melody Editor .....	127
Navigating a WAP Page .....	88	Phone Help .....	136
<b>My Stuff</b> .....	<b>92</b>	<b>Profiles</b> .....	<b>137</b>
Pictures .....	92	Activating a Profile .....	137
Games & More .....	99	Customising Profiles .....	138
Sounds .....	102	Resetting Profile Settings .....	138
Videos .....	105	Ringer Volume .....	139
Bookmarks .....	108	Assigning Ringtone .....	139
Text Templates .....	109	Vibration .....	140
Memory Status .....	110	Light Colour .....	140
<b>Games &amp; More</b> .....	<b>111</b>	Keypad Tones .....	140
Executing Applications .....	111	Warning Tone .....	141
Screensavers .....	111	Power On/Off Sound .....	142
More Games .....	112	Message Alert .....	142

Low Battery Alert .....	143	Handset Manager .....	191
Echo Reduction .....	143	Software Installation .....	192
Any Key Answer .....	144	Note .....	192
<b>Contacts .....</b>	<b>145</b>	<b>Troubleshooting .....</b>	<b>193</b>
Call Log .....	145	<b>Safety Precautions and Conditions of</b>	
Call Timers .....	146	<b>Use .....</b>	<b>195</b>
Call Costs .....	147	CONDITIONS OF USE .....	195
Data Counter .....	150	ENVIRONMENT .....	198
Speed Dial List .....	150	PRECAUTIONS CONCERNING	
My Numbers .....	151	VEHICLE USE .....	199
<b>Settings .....</b>	<b>152</b>	SAR .....	199
Phone Settings .....	152	PRECAUTIONS FOR USE IN USA .....	200
Call Settings .....	165	<b>Index .....</b>	<b>203</b>
Diverts .....	168		
Memory Card .....	170		
Connectivity .....	171		
Internet Settings .....	176		
Network Settings .....	182		
Security .....	184		
Master Reset .....	190		
<b>Connecting GX30 to Your PC .....</b>	<b>191</b>		
System Requirements .....	191		
GSM/GPRS Modem .....	191		

## **Your Phone**

Please check the following carefully. Your phone should come complete with:

- GSM 850/900/1800/1900 GPRS phone
- Rechargeable Li-ion battery
- AC charger
- Handsfree Kit
- CD-ROM
- SD memory card
- User guide

## **Optional Accessories**

- Spare Lithium-ion battery (XN-1BT30)
- High capacity Lithium-ion battery (XN-1BT31)
- Cigarette lighter charger (XN-1CL30)
- USB data cable (USB cable: XN-1DC30)
- AC charger (XN-1QC30, XN-1QC31)
- Personal handsfree kit (XN-1ER20)

The above accessories may not be available in all regions.

For details, please contact your dealer.



## Getting Started

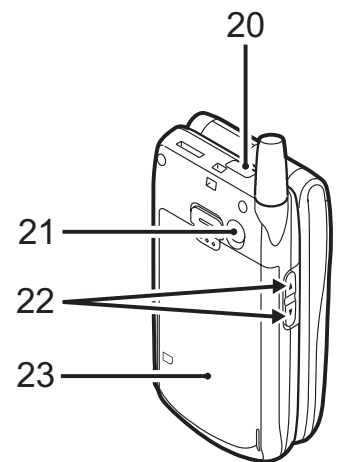
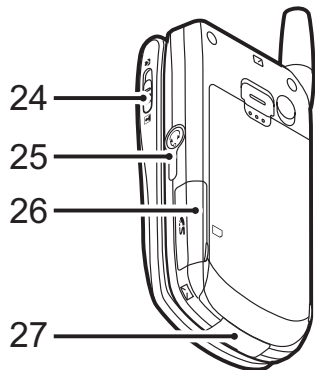
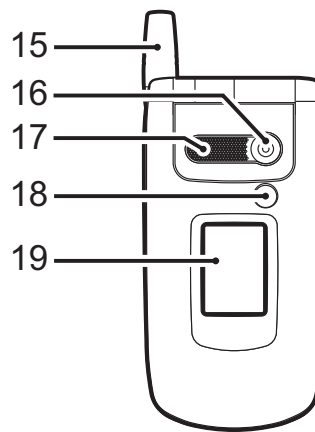
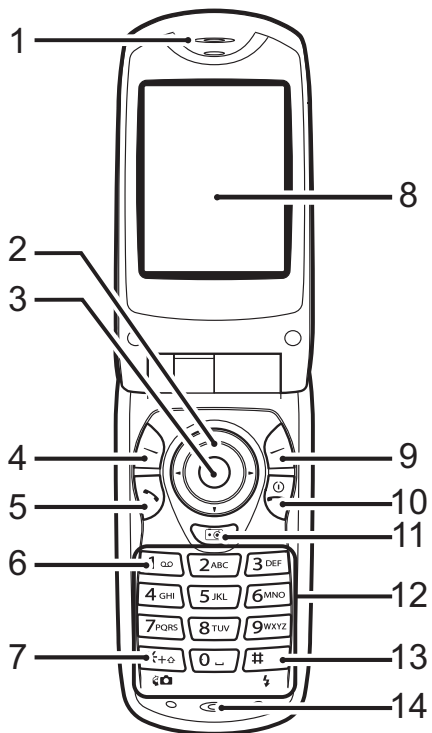

**1. Earpiece**

**2. Navigation Keys (Arrow Keys):**

Moves cursor to select menu items, etc.  
 in this manual indicate these keys.

Up/Down arrow keys: Displays Contacts List entries in stand-by mode.

Left arrow key: Displays list of Applications in stand-by mode.

Right arrow key: Displays Pictures screen in stand-by mode.

**3. Centre Key:** Displays Main menu in stand-by mode and executes functions.  
 in this manual indicates this key.

**4. Left Soft Key:** Executes the function at the bottom left of the screen.  
 in this manual indicates this key.

**5. Send Key:** Makes or accepts calls, views the call in stand-by mode.

**6. Voice Mail Key:** Press and hold this key to connect to the Voice mail centre automatically.  
(Depends on the SIM card.)

**7. \* /Shift Key, Viewfinder Switch Key:** Switches character case among four modes: Abc, ABC, 123 and abc. Switches viewfinders between main display and external display in digital camera/video camera mode.

**8. Main Display**

**9. Right Soft Key:** Executes the function at the bottom right of the screen.  
 in this manual indicates this key.

Used to access “Vodafone live!” by opening the browser in stand-by mode.

- 10.End/Power Key:** Ends a call, turns power on/off.
- 11.Camera Key:** Starts the digital camera in stand-by mode.
- 12.Keypad**
- 13.#/Flash light Key:** Switches symbol screens. Press and hold this key to shift text input method between multi-tap and T9 mode.  
Turns the flash/auxiliary light on or off in digital camera/video camera mode.
- 14.Microphone**
- 15.Aerial**
- 16.Camera**
- 17.Speaker**
- 18.Mobile Light:** Used as a flash or an auxiliary light in digital camera/video camera mode, as a battery charge indicator, or notification for incoming calls, data/fax calls or messages.
- 19.External Display**
- 20.Infrared Port:** Sends and receives data via infrared.
- 21.RF Connector**
- 22.Side-Up/Side-Down Keys:** Moves cursor to select menu items, adjusts earpiece volume, etc. In stand-by mode, press and hold this key to turn the mobile light on and off. When the mobile light is on, press this key to change the light colour.
- 23.Battery Cover**

**24. Macro Switch:** Switches between normal (👤) and macro (🌸) position.  
**(Close-up)**

**25. Handsfree Kit Connector**

**26. Memory Card Slot Cover**

**27. External Connector:**

Used to connect either the charger or USB data cable.

## Inserting the SIM Card and the Battery

1. Slide off the battery cover (① ②).

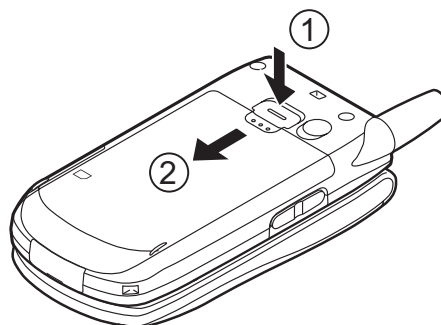

2. Slide the SIM card into the SIM holder.

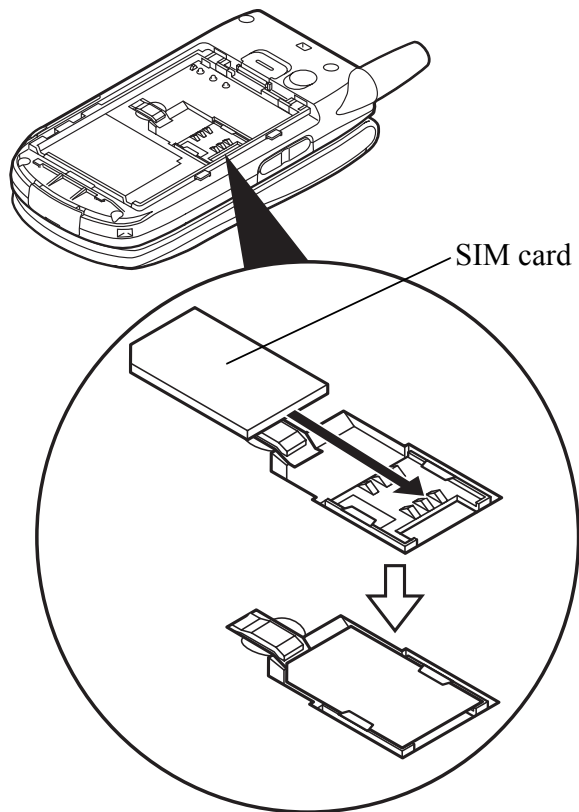

3. Hold the battery so that the metal contacts of the battery are facing down, slide the guides on the top of the battery into the battery slots ①, and then insert it ②.

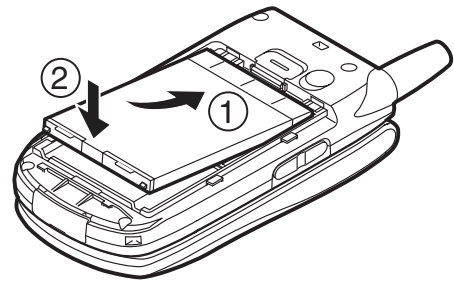

4. Replace the battery cover and slide it as shown below.

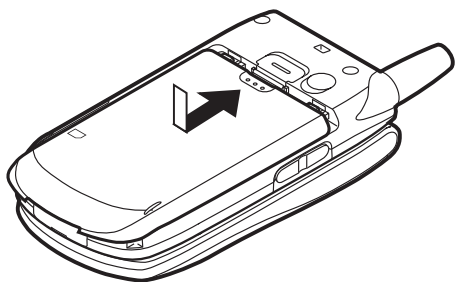

**Note**

- Make sure that only 3V SIM cards are used.
- Make sure that the standard accessory battery (XN-1BT30) or the optional accessory, high capacity Li-ion battery (XN-1BT31) is used.

**Removing the SIM Card and the Battery**

1. Make sure to turn off your phone and disconnect the charger and other accessories. Slide off the battery cover ① ②.

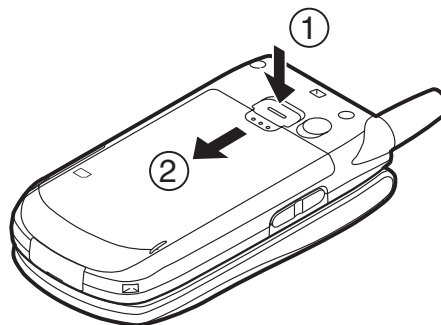

2. Pick up the battery using the protruding edge and remove the battery from the phone.

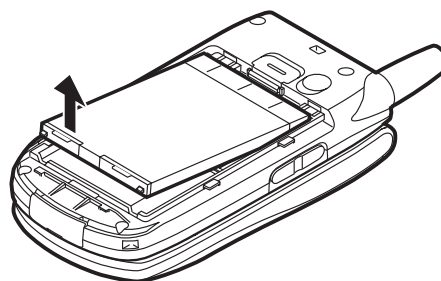

3. Hold down gently ① whilst sliding the SIM card out of the SIM holder ②.

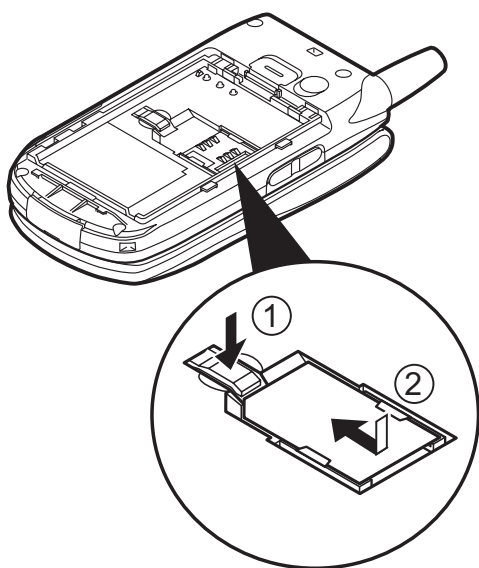

### **Battery Disposal**

The device is supported by a battery. In order to protect the environment, please read the following points concerning battery disposal:

- Take the used battery to your local waste depot, dealer or customer service centre for recycling.
- Do not expose the used battery to an open flame, into water or dispose with the household waste.

## Charging the Battery

You must charge the battery for at least 2 hours before using your phone for the first time.

### Using the Charger

1. Connect the charger to the external socket located at the bottom of the phone by pressing both sides indicated with arrows, and connect to an AC outlet.

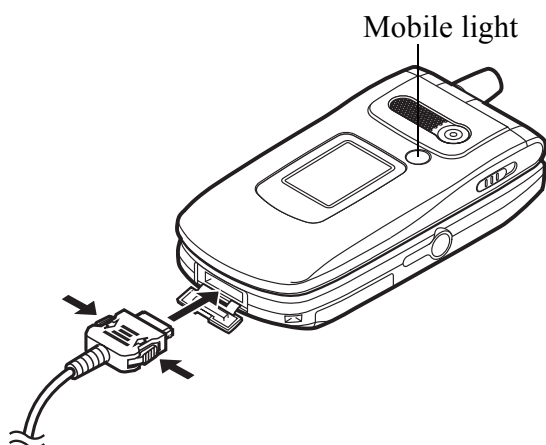

The mobile light lights red.  
Standard charging time: Approx. 2 hours.

### Note

- Charging time may vary depending on the state of the battery and other conditions. (See "Battery" on page 196.)

### To Disconnect the Charger

Push and hold the side buttons of the charger, then disconnect the charger from the external socket of the phone.

2. When charging is complete, the mobile light turns off. Unplug the charger from the AC outlet, then unplug the charger connector from the phone.

### Note

- Do not use any non approved charger, this may damage your phone and invalidate any warranty, please see "Battery" on page 196 for details.
- When the phone is charging, the animated battery status icon (  ) in the upper right of the screen displays the current status.

### To Charge Using the Cigarette Lighter Charger

The optional cigarette lighter charger supplies power for charging from the cigarette lighter socket of a car.

### Battery Level Indicator





The current battery level is displayed in the upper right hand side of the main display and the external display.



### Low Battery During Use

When the battery is running low, an alarm will sound and the “” is displayed on the main display and the external display.

If you are using your phone and you hear the “low battery” alarm, attach your charger as soon as possible. The phone may not be able to continue normal operation if you continue to use it. The battery may only last approximately five minutes before the phone itself powers down during a call.

Battery Indicators	Charge Level
	Sufficiently charged
	Partially charged
	Charging recommended
	Charging required
	Empty

### Inserting the Memory Card

1. Turn off the phone.
2. Open the memory card slot cover.

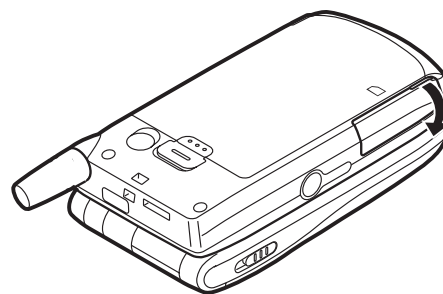

3. Insert the memory card all the way in.

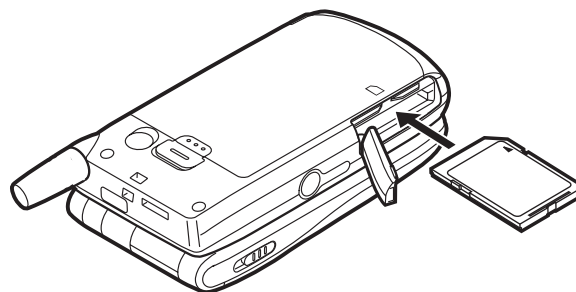

#### 4. Close the cover.

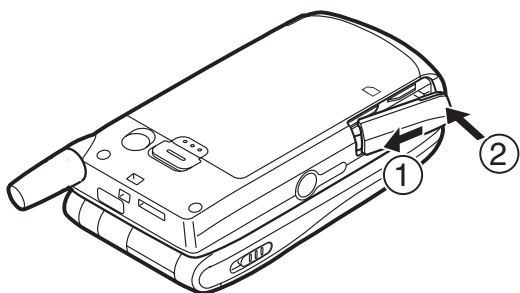

#### Note







- The miniSD memory card cannot be used with your phone.
- Make sure that the phone is turned off before inserting the memory card.
- Use only SD memory cards up to 512 MB, or MMC up to 128 MB.
- Be sure to insert the card in the correct direction and orientation.
- The SD memory card has a write-protect switch that prevents you from deleting memory contents by accident. If you slide the switch to the lock position, you cannot save or delete files.

- Do not open the memory card cover whilst the memory card is being formatted or written to. The card may be damaged beyond use.
- Keep all memory cards out of the reach of small children.

#### Memory Card Folder Configurations

Four folders entitled PICTURES, SOUNDS, VIDEOS, BACKUP are created on the memory card. The pictures and sounds, and video clips are stored in each entitled folder.

#### Tip

- You see the following indicators when the memory card is in use:
  -  : Appears when the card is inserted.
  -  : Appears when the card is inserted and locked.
  -  : Appears when the card is damaged or unusable.
  -  : Appears when the card is locked and damaged or unusable.
  -  : Appears when the card is being written or read.
  -  : Appears when the card is being formatted.

## Removing the Memory Card

1. Open the memory card slot cover, remove the card, and close the cover.

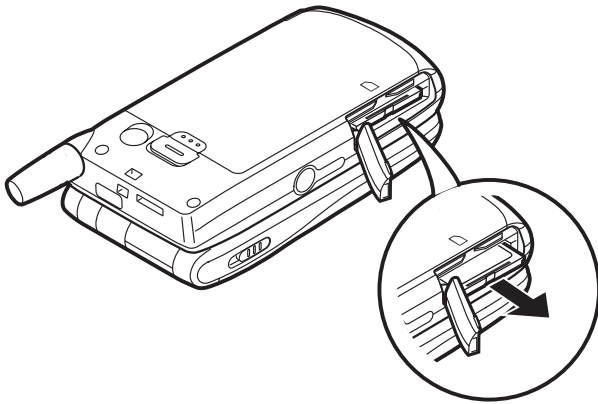

### **Note**

- Make sure that the phone is turned off before removing the memory card.
- Do not remove the memory card whilst the memory card is being formatted or written to.

## Turning Your Phone On and Off

To turn the power on, press and hold  for approximately 2 seconds.

The stand-by screen is displayed.

To turn the power off, press and hold  for approximately 2 seconds.

### To Enter the PIN Code

If activated you are asked to enter a PIN (Personal Identification Number) code after turning on your phone.



















1. Enter your PIN code.
2. Press .

### **Note**

- If your PIN code is entered incorrectly three times in a row, the SIM card is locked. See “Enabling/Disabling the PIN Code” on page 184.

### To Copy Contacts List from the SIM Card







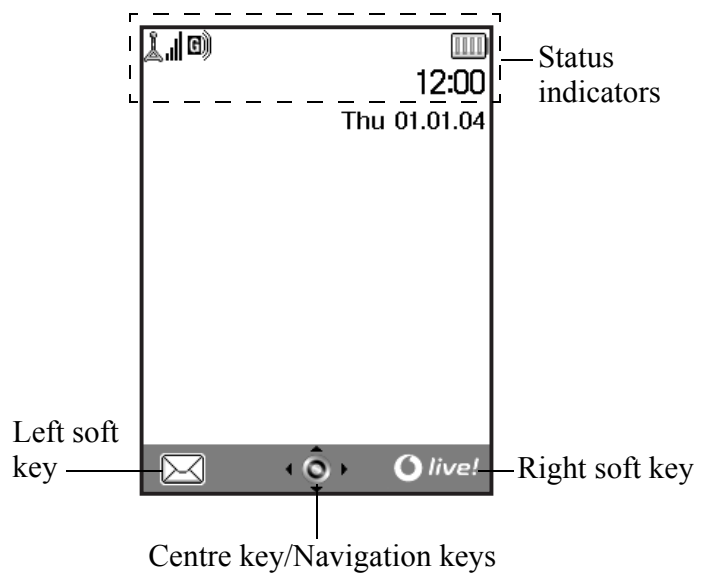













When you insert the SIM card into your phone for the first time and start the Contacts List application, you are asked whether you wish to copy Contacts List entries on the SIM card. Follow the on-screen instructions, or you can do it later using the Contacts List menu as follows:







1. Press  to display the Main menu.
2. Press , ,  or  to highlight “Contacts”, then press  to select.
3. Press  or  to highlight “Contacts List”, then press  to select.
4. Press  [Options] to display Options menu.
5. Press  or  to highlight “Advanced”, then press  or  [Select] to select.
6. Press  or  to highlight “Copy All from SIM”, then press  to select.
7. Press  [Yes] to start copying.  
To cancel copy, press  [No] in step 7.

### Display Indicators (Main Display)

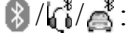

## Status Indicators

-  : Indicates the strength of received signal/the service is out of range.
-  : Appears when your phone is GPRS enabled and within range.  
Flashes during GPRS transmission.
-  /  /  : Appears when a new text message, multimedia message alert or WAP alert has arrived.
-  : Appears when the memory card (p. 16) is inserted.
-  /  : Appears when the application is executed (colourful) or suspended (sepia).
- (No display) /  /  /  /  /  : Indicates the phone's mode (Normal mode/Activity mode/Car mode/Headset mode/Silent mode).
- T9** : Appears when the T9 text input method is activated.
- Abc / ABC / abc / 123** : Indicates the text input method (First letter upper case mode/Upper case mode/Lower case mode/Numeric mode).
-  : Appears when "Diverts" (p. 168) is set to "All Calls".
-  : Appears when viewing secured WAP page.
-  : Appears during an incoming call.
-  : Appears when in call.
-  : Appears when the WAP or MMS communication is in CSD or GPRS mode.
-  : Indicates the battery level.
-  : Appears when your phone is roaming outside of your network.
-  : Appears when "Ringer Volume" (p. 139) is set to "Silent".

- 17. : Appears when vibration (p. 140) alert is set.
- 18. : Appears when the USB data cable is connected to your phone.
- 19. : Appears when “Infrared” is on/during connection.
- 20. : Appears when the Bluetooth is activated, when communicating with the handsfree headset for Bluetooth or with the handsfree car kit for Bluetooth.
- 21. : Appears when your phone is in data communication mode.
- 22. : Appears when your phone is in fax communication mode.
- 23. : Appears when the Outbox contains multimedia messages you failed to send.
- 24. : Appears when a voicemail message is stored.

- 25. : Appears when the daily alarm or the alarm for the specified date and time is set.

### Soft Key Indicators

To execute the operation indicated, press the corresponding key.

- 26. Area at the lower left of the screen:  
Displays the operation executed by left soft key.
- 27. Area at the lower right of the screen:  
Displays the operation executed by right soft key.

### Centre Key/Navigation Keys Indicators

To execute the operation indicated, press the corresponding key.

28. Area at the lower centre of the screen:

Displays the operation executed by the centre key. (For centre key options, use the Options menu displayed by the left soft key.)





29. Around the centre key indicator:

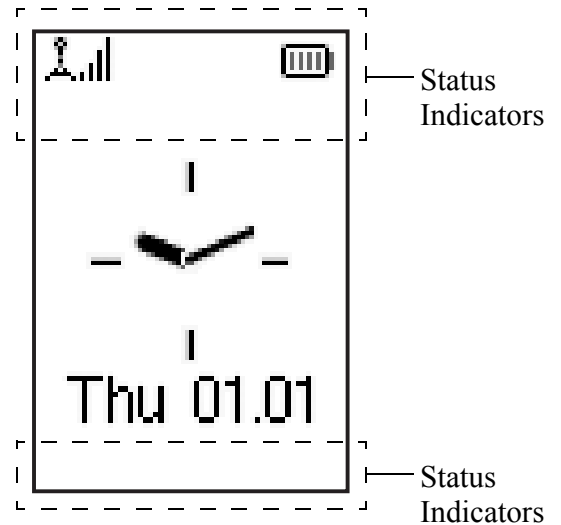













Appears when up, down, right or left navigation is available.

### Display Indicators (External Display)



#### Status Indicators



1. : Indicates the strength of received signal.
2. : Appears when a new text message, multimedia message alert or WAP alert has arrived.
3. : Appears during an incoming call.
4. : Appears when in call.

- |   |  |
|---|--|
| <p>5. : Appears when the WAP or MMS communication is in CSD or GPRS mode.</p> <p>6. : Indicates the battery level.</p> <p>7. : Appears when your phone is GPRS enabled and within range. Flashes during GPRS transmission.</p> <p>8. : Appears when the Outbox contains multimedia messages you failed to send.</p> <p>9. : Appears when “Ringer Volume” (p. 139) is set to “Silent”.</p> <p>10. : Appears when “Diverts” (p. 168) is set to “All Calls”.</p> <p>11. : Appears when your phone is roaming outside of your network.</p> <p>12. : Appears when your phone is in data communication mode.</p> <p>13. : Appears when the phone is in fax communication mode.</p> | <p>14. : Appears when the USB data cable is connected to your phone.</p> <p>15. : Appears when “Infrared” is on/during connection.</p> <p>16. : Appears when the Bluetooth is activated, when communicating with the handsfree headset for Bluetooth or with the handsfree car kit for Bluetooth.</p> <p>17. : Appears when the daily alarm or the alarm for the specified date and time is set.</p> <p>18. : Appears when the memory card (p. 16) is inserted.</p> |
|---|--|



## Call Functions

### Making a Call

1. Enter the area code and the phone number you wish to dial.  
If you enter the wrong number, press  [Clear] to delete the number to the left of the cursor.
2. Press  to dial.



### Emergency Calls

1. Enter 112 (international emergency number) using the keypad.
2. Press  to dial.

#### *Note*

- *Emergency calls may not be available on all mobile phone networks when certain network services and/or phone features are in use. Contact your network operator for more information.*
- *This Emergency number can normally be used to make an emergency call in any country, with or without a SIM card inserted, if a GSM network is within range.*



### International Calls

1. Press and hold  until a “+” (international dialling prefix) sign is displayed.
2. Enter the country code, followed by the area code and the number.
3. Press  to dial.



#### *Note*

- *Enter the area code omitting the first 0 when making international calls, in most cases. (It differs for some countries.)*

### Speed Dialling







Up to 9 phone numbers from the Contacts List memory (Handset and SIM) can be assigned to speed dials. You can call the numbers using the digit keys ( to  and .

For details on setting the Speed Dial List, see “Speed Dial List” on page 49.

1. To dial a number using the speed dial, press and hold any of the digit keys ( to  and ).  
The phone number stored in the Speed Dial List is dialled.



## Redialling

You can redial the numbers in the call log list that you may have missed, received or dialled. Each list can contain up to 10 numbers.









1. Press  during stand-by.
2. Press  or  to highlight a category between “Dialled Numbers”, “Missed Calls” and “Received Calls”.
3. Press  or  to highlight the number you wish to call.
4. Press  to redial the call.







## Automatic Redialling

This setting allows you to automatically redial the number if the first attempt was unsuccessful because the called party was busy.

If you wish to stop redialling, press  or  [End].

### To Set the Auto Redial Function

1. Press  to display the Main menu.
2. Press , ,  or  to highlight “Settings”, then press  to select.
3. Press  or  to highlight “Call Settings”, then press  to select.

4. Press  or  to highlight “Auto Redial”, then press  to select.
5. Press  or  to highlight “On” to enable the Auto Redial function or “Off” to disable it, then press .

### Note

- When you receive an incoming call, the Auto Redial function is interrupted.
- Automatic redialling is not available for fax and data calls.

## Ending a Call





1. Press  to end the call.

### Tip

- When the handsfree kit is connected to the phone, you can end calls by pressing the Answer button.

## Answering a Call

When an incoming call is detected, the phone rings and the mobile light flashes.

1. Open your phone.
2. Press ,  or  [Answer] to answer the call.  
Or press any key except  and  [Busy] when the “Any Key Answer” function is enabled. Set the Any Key Answer function in the profile of each mode. (p. 144)

### Tip

- *When the handsfree kit is connected to the phone, you can answer calls by pressing the Answer button.*
- *When the handsfree kit is connected to the phone and the Any Key Answer function is enabled, you can answer calls by pressing the side-up or side-down key.*
- *If you have subscribed to the Calling Line Identification (CLI) service and the caller’s network sends the number, the caller’s number is displayed on the screen. If the caller’s name and number are stored in the Contacts List, the caller’s name and phone number are displayed on the screen.*
- *If the number is a restricted number, the display shows “Withheld”.*
- *When receiving a call from the person whose picture is registered in the Contacts List, receiving display and the picture are displayed alternately.*

## Rejecting an Incoming Call

You can reject a call you do not wish to answer.

1. Press  or press and hold the side-up or side-down key whilst the phone is ringing.

## Letting the Caller Know You are Unavailable

You can send a busy tone to the caller of an incoming call letting them know that you cannot answer the call.



1. Press  [Busy] whilst the phone is ringing.

## Incall Menu

Your phone has additional functions available whilst a call is in progress.

### Adjusting the Earpiece Volume

During a call, you can adjust the earpiece volume (and handsfree volume, if connected).

1. During a call, press the side-up or side-down key to display the Earpiece Volume screen.
2. Press the side-up key or  to increase the volume of the call or press the side-down key or  to decrease the volume.  
Five levels (level 1 to 5) are selectable.
3. Press  when the volume is set to the desired level.





The phone returns to the in-call screen automatically if left unoperated.

### Putting a Call on Hold





This function allows you to manage two calls at the same time. If you wish to make another call whilst you are talking to someone, you can put the current call on hold to call someone else.

#### To Make Another Call during a Call

1. During a call, press  [Options] to display the Options menu.

2. Press  or  to highlight “Hold”, then press  or  [Select] to select.

The current call is put on hold.

To retrieve a call, press  [Options] and press  or  to highlight “Retrieve”, then press  or  [Select] to select.















3. Enter the phone number you wish to make another call to, then press .

#### Tip







- You can also make another call by entering the phone number during a call instead of steps 1 and 2. The current call is automatically put on hold.

## Call Waiting





This service notifies you of another incoming call whilst you have a call in progress.

1. During a call, press  [Options] and press  or  to select “Hold & Answer”, then press  or  [Select] to answer the second call.  
The first call is put on hold and you can now talk to the second caller.
2. Press  [Options] and press  or  to highlight “Swap Calls”, then press  or  [Select] to switch between the two calls.
3. Press  [Options] and press  or  to highlight “Release Call”, then press  or  [Select] to end the current call and return to the held call.

### Note

- You need to set “Call Waiting” to “On” if you use the Call Waiting service (p. 165).
- Call Waiting service may not be available on all networks. Contact your network operator for more information.
- If you do not wish to answer the second call, press  [Busy], or press  [Options], then press  or  to highlight “Busy” or “Reject”, then press  or  [Select] in step 1. If “Reject” is selected, the call log of the second call is saved as a missed call.

## Accessing SMS Menu During a Call

1. During a call, press  [Options] and press  or  to highlight “Text”, then press  or  [Select] to select.









The following options are available: “Create Message” to make an SMS, or “Inbox”, “Sent” or “Drafts” to access these folders. For details on SMS, see “Text (SMS)” on page 77.

## Conference Call

Conference call is a call with more than 2 participants. You may include up to 5 participants in a conference call.

### To Make a Conference Call

To make a conference call, you must have one active call and one held call.















1. Press  [Options] to display the Options menu.
2. Press  or  to highlight “Multiparty”, then press  or  [Select] to select.
3. Press  or  to highlight “Conference All”, then press  to join the conference call.
4. Press  to end the conference call.

### Note

- *Conference call service may not be available on all networks. Contact your network operator for more information.*
- *You have more options for the Conference call in step 3:*
  - *To put all participants on hold, select “Conference Hold All”.*
  - *To put all participants except the current call on hold, select “Private”.*
  - *To end the call with all participants, select “Release All”.*







- *To disconnect from the conference call but still allow the other participants to continue talking together, select “Transfer”.*
- *To put the current call on hold and continue to have a conference call with the remaining participants, select “Exclude”.*
- *To reject adding more participants to the current party, select “Reject”, or you can send the busy tone by selecting “Busy”.*

### To Add New Participants to the Conference Call

1. Press  [Options] to display the Options menu.
2. Press  or  to highlight “Dial”, then press  or  [Select] to select.
3. Enter the number you wish to include in the conference call.
4. Press  to dial.
5. Press  [Options] to display the Options menu.
6. Press  or  to highlight “Multiparty”, then press  or  [Select] to select.
7. Press  or  to highlight “Conference All”, then press  to join the conference call.

















If you wish to add other participants, repeat steps 1 to 7.

### To End the Call with a Conference Call Participant





1. During a conference call, press  or  to highlight the person that you wish to disconnect from the conference call.
2. Press  [Options] to display the Options menu.
3. Press  or  to highlight “Release Call”, then press  or  [Select] to select.

### To Have a Private Conversation with One of the Participants

If you wish to have a private conversation with one of the participants, you may select the participant from the conference list and put the other participants on hold.

1. During the conference call, press  or  to highlight the person that you wish to talk to.
2. Press  [Options] to display the Options menu.
3. Press  or  to highlight “Multiparty”, then press  or  [Select] to select.
4. Press  or  to highlight “Private”, then press  to select.
5. Once you have finished the private conversation, press  [Options] and highlight “Multiparty”, then press  or  [Select] to select.
6. Press  or  to highlight “Conference All”, then press  to return to the conference call.

### **Muting the Dial Tone (DTMF Tone)**

1. During a call, press  [Options] and press  or  to highlight “DTMF Tones Off”, then press  or  [Select].

To unmute the dial tone, highlight “DTMF Tones On” in step 1.

### **Muting the Microphone**

1. During a call, press  [Mute] to mute the microphone.

To unmute the microphone, press  [Unmute].



## Entering Characters







When entering characters to create Contacts List entries, text messages or multimedia messages, etc., press the corresponding keys.







In multi-tap input method, press each key until the desired character is displayed. For example, press  once for the letter “A” or twice for the letter “B”.



### Table of Characters

Pressing each key scrolls characters in the following order. The order varies depending on the language selected.

#### English Mode

Key	Upper Case Characters	Lower Case Characters	Numeric
	. (full-stop) , (comma) - (hyphen) ? ! ' (apostrophe) @ :1		1
	ABC2	abc2	2
	DEF3	def3	3
	GHI4	ghi4	4
	JKL5	jkl5	5
	MNO6	mno6	6

Key	Upper Case Characters	Lower Case Characters	Numeric
	PQRS7	pqrs7	7
	TUV8	tuv8	8
	WXYZ9	wxyz9	9
	(space)+ = < > € £ \$ ¥ % & 0		0
	Switches character case among four modes: Abc, ABC, 123 and abc.		
	. , ? ! : ; - + # * @ ' " ( ) _ & € £ \$ % / ~ < > § = \   ¥ ÿ î ^ [ ] { } □ Å Ä Æ å ä æ à Ç É è é ì Ñ ñ Ò Ø ö ø ò ß Û ü ù Δ Φ Γ Λ Ω Π Ψ Σ Θ Ξ (space) ↵		









 -  : Press and hold to enter 0 - 9 numbers.

 : Press and hold to enter \*.

 : Press and hold to shift between multi-tap and T9 mode.

## Changing the Input Languages









You can change the input language on the text entry screen.

1. On the text entry screen, press  [Options] to display the Options menu.
2. Press  or  to highlight “Input Language”, then press  or  [Select] to select.
3. Press  or  to highlight the language you wish to change, then press  to select.

## Changing the Input Method

### T9 Text Input



T9 text input method is a shortcut to enter text easily and quickly.

1. On the text entry screen, press  [Options] to display the Options menu.
2. Press  or  to highlight “Input Method”, then press  or  [Select] to select.
3. Press  or  to highlight the T9 mode (T9 Abc, T9 ABC, T9 abc) you wish to change, then press  to select.

“T9” is displayed on the main display.

4. Press each key once for any letter you require on that key.

To enter the word “How”, press   .

5. If the word shown isn’t the one you want, press  or  until you highlight the correct one.
6. Press  to select the word.

### Note

- If the correct word is not shown in step 5, enter the correct word again after switching to the multi-tap input method.

### Tip

- If you press  instead of step 6, a space is inserted next to the selected word.

### Symbols and Punctuations

To enter symbols or punctuation, press .

## Using Text Templates

You can use the sentences registered in Text Templates when entering characters.

For details on creating the text template, see “Adding Phrases to Text Templates” on page 109.

1. On the text entry screen, press ▲, ▼, ◀ or ▶ to move the cursor to the point you wish to insert the template.
2. Press ⏏ [Options] to display the Options menu.
3. Press ▲ or ▼ to highlight “Text Template”, then press ● or ⏏ [Select] to select.
4. Press ▲ or ▼ to highlight the text template you wish to use, then press ● to select.

The selected text template is inserted.

## Copying, Cutting and Pasting Text

Using these options, you can complete editing smoothly.

### To Copy and Cut Text

1. On the text entry screen, press ⏏ [Options] to display the Options menu.
2. Press ▲ or ▼ to highlight “Copy” or “Cut”, then press ● or ⏏ [Select] to select.
3. Press ▲, ▼, ◀ or ▶ to move the cursor to the first letter to be copied or to be cut, then press ●.
4. Press ▲, ▼, ◀ or ▶ to move the cursor to the last letter to highlight the area, then press ●.





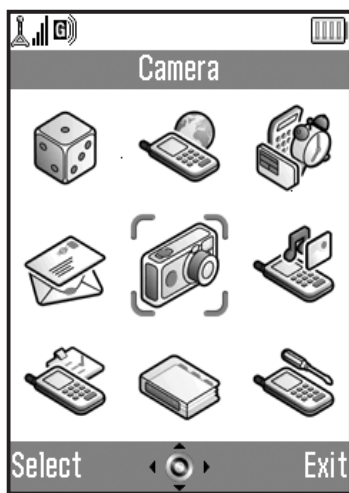

### To Paste Text

1. On the text entry screen, press ▲, ▼, ◀ or ▶ to move the cursor to the point you wish to paste the letters.
2. Press ⏏ [Options] to display the Options menu.
3. Press ▲ or ▼ to highlight “Paste”, then press ● or ⏏ [Select] to select.  
Saved text is pasted.

## Using the Menu

### Using the Main Menu





1. Press  during stand-by.  
The Main menu is displayed.
2. Press , ,  or  to navigate to required location.
3. Press  to access function.

Pressing digit keys for the menu's corresponding number also accesses function. In this manual, the operation to access function is described by navigation keys operation.

To return to the previous screen, press  [Back] if the right soft key displays [Back].

To close the Main menu, press  [Exit].

### Operation Guidance

Your phone uses soft keys to help you to navigate the phone ( and ). These keys change usage depending on the situation. The function of each soft key at any given time is highlighted at the bottom left and bottom right of the screen.

The function of the centre key is displayed in the centre at the bottom of the screen by the graphical icon.

### Shortcut Keys

You can shortcut to the specified menus by pressing  and digit keys for the menu's corresponding number on the Main menu. See the following table for reference. Shortcuts are listed in the headings of this manual. For example: "M 9-1-1".

Example: To Access “Language” Sub Menu  
Using Shortcut Keys

Press    .

**Note**

- *The shortcut keys work for the first three menu levels only.*

## List of Menu Functions

Menu No./ Main Menu	Menu No./ Sub Menu1
<b>1</b> Games & More	<b>1</b> Applications <b>2</b> Screensavers <b>3</b> More Games <b>4</b> Settings <b>5</b> Java™ Information
<b>2</b> Vodafone live!	<b>1</b> Vodafone live! <b>2</b> Games <b>3</b> Ringtones <b>4</b> Pictures <b>5</b> News <b>6</b> Sport <b>7</b> Find & Seek <b>8</b> Chat <b>9</b> Search
<b>3</b> Applications	<b>1</b> SIM Application* <b>2</b> MP3 Player <b>3</b> Calendar <b>4</b> Alarms <b>5</b> Calculator <b>6</b> Voice Recorder <b>7</b> Melody Editor <b>8</b> Phone Help
<b>4</b> Messages	<b>1</b> Create Message <b>2</b> Multimedia <b>3</b> Text <b>4</b> Media Album <b>5</b> Vodafone Mail <b>6</b> Messenger <b>7</b> Cell Broadcasts <b>8</b> Area Info

Menu No./ Main Menu	Menu No./ Sub Menu1
<b>5</b> Camera	<b>1</b> Take Picture <b>2</b> Record Video
<b>6</b> My Stuff	<b>1</b> Pictures <b>2</b> Games & More <b>3</b> Sounds <b>4</b> Videos <b>5</b> Bookmarks <b>6</b> Text Templates <b>7</b> Memory Status
<b>7</b> Profiles	<b>1</b> Normal <b>2</b> Activity <b>3</b> Car <b>4</b> Headset <b>5</b> Silent
<b>8</b> Contacts	<b>1</b> Contacts List <b>2</b> Add New Contact <b>3</b> Call Log <b>4</b> Speed Dial List <b>5</b> My Numbers
<b>9</b> Settings	<b>1</b> Phone Settings <b>2</b> Call Settings <b>3</b> Diverts <b>4</b> Memory Card <b>5</b> Connectivity <b>6</b> Internet Settings <b>7</b> Network Settings <b>8</b> Security <b>9</b> Master Reset

\* Depends on SIM card contents.

## **Contacts List (M 8-1)**

You can store the phone numbers and e-mail addresses of your friends, family and colleagues in the Contacts List.

Your phone can store up to 500 phone numbers. In a Contacts List, you can store the following items.









### **Items stored in the handset memory**

- Name: Up to 30 characters
- Phone number: Up to 40 digits, 3 phone numbers / entry
- E-mail Address: Up to 60 characters, 2 addresses / entry
- Group: Selectable from 7 groups
- Address: Up to 100 characters
- Note: Up to 60 characters

### **Items stored in the SIM memory**





- Name: The number of characters that can be stored differs depending on the SIM card you use.
- Phone number: Up to 40 digits

## **Displaying the Contacts List**

1. Press  to display the Main menu.
2. Press , ,  or  to highlight “Contacts”, then press  to select.
3. Press  or  to highlight “Contacts List”, then press  to select.

## **Selecting the Contacts List Memory**

You can store new entries in the Contacts Lists (either in the handset memory or SIM card memory) or view currently saved entries.

1. Perform steps 1 to 3 in “Displaying the Contacts List”.
2. Press  [Options] to display the Options menu.
3. Press  or  to highlight “Advanced”, then press  or  [Select] to select.

The steps to be performed after step 3 differ depending on whether you wish to store new entries or view Contacts List entries.

#### When you store new entries



4. After performing steps 1 to 3, press ▲ or ▼ to highlight “Save New Contacts to”, then press ● to select.
5. Press ▲ or ▼ to highlight “Handset Memory”, “Choice” or “SIM Memory”, then press ● to select.

When selecting “Choice”, you can choose SIM card or handset memory every time you store a new Contacts List entry.

#### When you wish to change the Contacts List memory

4. After performing steps 1 to 3, press ▲ or ▼ to highlight “Contacts Location”, then press ● to select.
5. Press ▲ or ▼ to highlight “Handset Memory” or “SIM Memory”, then press ● to select.

#### Tip

- The Contacts Location indicator (handset:  or SIM: ) is displayed so that you can find the memory you are using.

## Add New Contact (M 8-2)





















You can choose either the phone or SIM card memory locations to store the new entry. For switching locations, see “Selecting the Contacts List Memory” on page 38.













The amount of phone numbers that you can store to the SIM card is dependent on its capacity. Contact your network operator for details.

If you create a new entry in the handset memory, you need to enter one of the following: “Name”, “Phone number” or “E-mail Address”. If you create a new entry on the SIM card, you need to enter: “Phone number”.

1. Perform steps 1 and 2 in “Displaying the Contacts List” on page 38.
2. Press ▲ or ▼ to highlight “Add New Contact”, then press ● to select.  
If you select the “Choice” option for the memory to be used, the selection is between “To Handset Memory” or “To SIM Memory”.  
The “New Entry” screen is displayed.
3. Press ▲ or ▼ to move the cursor to the name field, then press ●.  
The name entry screen is displayed.











4. Enter a name, then press .  
For details on entering characters, see “Entering Characters” on page 32.
5. Press  or  to move the cursor to the phone field, then press .  
The phone number entry screen is displayed.
6. Enter the phone number, then press .  
Up to 40 digits can be entered.
7. Press  or  to highlight a desired number type, then press  to select.  
Steps 7 to 17 in this section cannot be performed if you use the SIM card for storing a new entry.
8. Press  or  to move the cursor to the e-mail field, then press .  
The e-mail address entry screen is displayed.
9. Enter an e-mail address, then press .
10. Press  or  to highlight the desired e-mail address type, then press  to select.
11. Press  or  to move the cursor to the group field, then press .  
The group selection screen is displayed.
12. Press  or  to highlight the desired group, then press  to select.

13. Press  or  to move the cursor to the address field, then press .  
The address entry screen is displayed.
14. Enter an address, then press .
15. Press  or  to highlight the desired address type, then press  to select.
16. Press  or  to move the cursor to the note field, then press .
17. Enter a note, then press .
18. Press  [Save].

### Adding a Thumbnail to an Entry

You can add a thumbnail to an entry in the handset memory.

1. Perform steps 1 to 3 in “Displaying the Contacts List” on page 38.
2. Press  or  to highlight the entry to which you wish to add a thumbnail, then press  to select.
3. Press  [Options] to display the Options menu.
4. Press  or  to highlight “Picture”, then press  or  [Select] to select.

5. Press ▲ or ▼ to highlight the desired picture, then press ● to select.

If the picture size exceeds 240 dots [W] or 320 dots [H], press ▲, ▼, ◀ or ▶ to specify the area you wish to display, then press ●.

6. Press ⏏ [Save] to save the entry.

To change the picture added, select “Change” after step 4.

To remove the picture added, select “Remove” after step 4.

**Note**

- Only pictures stored in the handset memory can be used as thumbnails.
- If you delete a picture added as a thumbnail in the handset memory, the corresponding thumbnail is also removed.

### Adding the Phone Number from Call Log Entries

1. Display the call log entry you wish to store (p. 145).
2. Press ⏏ [Options] to display the Options menu.
3. Press ▲ or ▼ to highlight “Save to Contacts”, then press ● or ⏏ [Select] to select.  
If you select the “Choice” option for the memory to be used, the selection is between “To Handset Memory” or “To SIM Memory”.
4. Perform steps 3 to 18 in “Add New Contact” on page 39.

### Storing an Input Phone Number

1. Enter the phone number, then press ⏏ [Options].  
The Options menu is displayed.
2. Press ▲ or ▼ to highlight “Save to Contacts”, then press ● or ⏏ [Select] to select.  
If you select the “Choice” option for the memory to be used, the selection is between “To Handset Memory” or “To SIM Memory”.
3. Perform steps 3 to 18 in “Add New Contact” on page 39.

### **Copying a Single Entry from Handset to SIM Card**

You can copy a single entry from the handset memory to the SIM card.

1. Perform steps 1 to 3 in “Displaying the Contacts List” on page 38.
2. Press ▲ or ▼ to scroll list for selecting the name you wish to copy, then press ● to select.
3. Press ▲ or ▼ to highlight the phone number you wish to copy to the SIM card.
4. Press ⏏ [Options] to display the Options menu.
5. Press ▲ or ▼ to highlight “Copy to SIM”, then press ● or ⏏ [Select] to select.
6. Press ⏏ [Yes].

The phone number and name selected in steps 2 and 3 are copied to the SIM card.

To cancel copying an entry, press ⏏ [No] in step 6.

### **Copying All Entries from SIM Card to Handset**









You can copy all entries from the SIM card to the handset memory at once.

When you insert the SIM card into your phone for the first time and start the Contacts List application, the confirmation screen appears automatically, asking you if you wish to copy or not.



1. Perform steps 1 to 3 in “Displaying the Contacts List” on page 38.
2. Press ⏏ [Options] to display the Options menu.
3. Press ▲ or ▼ to highlight “Advanced”, then press ● or ⏏ [Select] to select.
4. Press ▲ or ▼ to highlight “Copy All from SIM”, then press ● to select.
5. Press ⏏ [Yes].

To cancel copying entries, press ⏏ [No] in step 5.

## Finding a Name and Number







1. Perform steps 1 to 3 in “Displaying the Contacts List” on page 38.
2. Press  [Options] to display the Options menu.
3. Press  or  to highlight “Search”, then press  or  [Select] to select.
4. Enter a name or the first character(s) of the name.  
The matching entry is highlighted.  
If there is no entry in the Contacts List that satisfies the exact search criteria, the name that is nearest alphabetically is displayed.
5. Press  or  to scroll through list for selecting the desired name, then press .  
The details screen of the Contacts List entry is displayed.

### Tip

- You can also find the desired name and number by entering characters using the keypad in step 2 (the screen in step 4 is displayed).
- To view the details of the item such as address, highlight the desired item, press  [Options], then select “View”. Press  [Back] to go back to the details screen.

## Dialling Using Contacts List Entries



### Dialling from the Contacts List Screen

1. Search for the desired Contact List entry.  
For details on searching through Contact List entries, see “Finding a Name and Number”.
2. On the list screen, press  or  to highlight the desired name, then press  to dial.
3. If two or more phone numbers are registered for the selected entry, press  or  to highlight the desired phone number, then press  to dial.

### Tip

- You can also dial the desired phone number by pressing the digit key corresponding to the list number instead of step 3.

### Dialling from the Contacts Details Screen











1. Search for the desired Contact List entry.  
For details on searching through Contact List entries, see “Finding a Name and Number”.
2. On the details screen, press  or  to highlight the desired phone number, then press  to dial.

### **Tip**







- If you select “SIM Memory” for the “Contacts Location” option in Contacts List menu (p. 38), only one phone number entry is displayed.
- If no entries are found in the list, you can create an entry from the list. Press  [Options]. Then follow the procedures as described on page 39.

## **Editing Contacts List Entries**













You can edit Contacts List entries by searching from the Contacts List or from each Contacts List entry.



1. Search for the desired Contacts List entry.  
For details on searching through Contacts List entries, see “Finding a Name and Number” on page 43.
2. Press  [Options] to display the Options menu.
3. Press  or  to highlight “Edit”, then press  or  [Select] to select.
4. Press  or  to move the cursor to the field you wish to edit, then press  to select.
5. When you have finished editing, press .  
If you wish to edit another field, repeat steps 4 and 5.
6. Press  [Save] to save the change(s).

## Deleting a Single Contacts List Entry

1. Search for a desired Contacts List entry.  
For details on searching through Contacts List entries, see “Finding a Name and Number” on page 43.
2. Press  [Options] to display the Options menu.
3. Press  or  to highlight “Delete”, then press  or  [Select] to select.
4. Press  [Yes].  
The selected entry is deleted.  
To cancel deletion, press  [No] in step 4.













## Deleting All Contacts List Entries

1. Perform steps 1 to 3 in “Displaying the Contacts List” on page 38.
2. Press  [Options] to display the Options menu.
3. Press  or  to highlight “Advanced”, then press  or  [Select] to select.
4. Press  or  to highlight “Delete All Entries”, then press  to select.
5. Enter your handset code, then press .
6. Press  or  to highlight “Handset Entries” or “SIM Entries”, then press  to select.

7. Press  [Yes].  
To cancel deletion, press  [No] in step 7.

## Viewing Groups

You can set group icons when storing Contacts entries so that you can easily find and edit them.

1. Perform steps 1 to 3 in “Displaying the Contacts List” on page 38.
2. Press  [Options] to display the Options menu.
3. Press  or  to highlight “Group”, then press  or  [Select] to select.
4. Press  or  to highlight “View Groups”, then press  to select.
5. Press  or  to highlight the group name you wish to view, then press  to select.  
“” indicates that the group has been selected.  
To cancel the selected group, press  again.  
The checkbox becomes blank again.



































### Tip

- In step 5, press  [Options] to display the Options menu, then select “Select Current Only” to view only the selected group or “Select All” to view all groups.

## Group Call

Different ringtones can be set for each group.

When you purchase this phone, groups are set to off. If you do not set a group ringtone, the ringtone assigned in the Profiles is used.

1. Perform steps 1 to 3 in “Displaying the Contacts List” on page 38.
2. Press  [Options] to display the Options menu.
3. Press  or  to highlight “Group”, then press  or  [Select] to select.
4. Press  or  to highlight “Group Call”, then press  to select.
5. Press  or  to highlight the group you wish to set, then press  to select.
6. Press  or  to highlight “On”, then press  to select.
7. Press  or  to highlight “Assign Ringtone”, then press  to select.
8. Press  or  to highlight “Preset Sounds” or “My Sounds”, then press  to select.
9. Press  or  to highlight a ringtone.  
For details on selecting a ringtone, see “Assigning Ringtone” on page 139.
10. Press  or  to highlight “Vibration”, then press  to select.
11. Press  or  to highlight “Enable”, “Disable” or “Link to Sound”, then press  to select.  
For details on setting the vibration, see “Vibration” on page 140.
12. Press  or  to highlight “Light Colour”, then press  to select.
13. Press  or  to highlight the desired colour, then press  to select.  
For details on setting the light colour, see “Light Colour” on page 140.
14. When setting is complete, press  [OK].

### Tip

- To cancel the ringtone setting, select “Off” in step 6.

### Assigning a Ringtone to Each Contacts List Entry

A specified ringtone, vibration and light colour setting can be associated to a pre-registered entry.

1. Perform steps 1 to 3 in “Displaying the Contacts List” on page 38.
2. Press ▲ or ▼ to highlight the entry you wish to set, then press ● to select.
3. Press ▲ or ▼ to move the cursor to the ringtone field (🎵), then press ⏏ [Options].
4. Press ▲ or ▼ to highlight “Edit”, then press ● or ⏏ [Select] to select.
5. Press ▲ or ▼ to highlight “On”, then press ● to select.
6. Perform steps 7 to 14 in “Group Call” on page 46.
7. When setting is complete, press ⏏ [Save].

#### Tip

- To cancel the ringtone setting, select “Off” after step 5.















### Making a Backup File on the Memory Card

With a memory card attached to your phone, you can make backup files of Contacts List entries in the handset memory and SIM card to the memory card.

1. Perform steps 1 to 3 in “Displaying the Contacts List” on page 38.
2. Press ⏏ [Options] to display the Options menu.
3. Press ▲ or ▼ to highlight “Advanced”, then press ● or ⏏ [Select] to select.
4. Press ▲ or ▼ to highlight “Backup”, then press ● to select.
5. Enter your handset code, then press ● .  
A confirmation message for overwriting is displayed if a backup file already exists in the memory card.  
Backup is performed.













## Restoring a Backup File

1. Perform steps 1 to 3 in “Displaying the Contacts List” on page 38.
2. Press  [Options] to display the Options menu.
3. Press  or  to highlight “Advanced”, then press  or  [Select] to select.
4. Press  or  to highlight “Restore”, then press  to select.
5. Enter your handset code, then press .
6. Press  or  to highlight “Handset Entries” or “SIM Entries”, then press  or  [Select] to select.  
If the handset memory or SIM memory contains one or more entries, a confirmation message is displayed asking you whether you wish to replace all entries in the handset memory or SIM memory with the backup file.
7. Press  [Yes].  
To cancel restoring, press  [No] in step 7.

### Note





- *It is not recommended to stop the backup or restoring procedure. It will damage the data.*

## Deleting a Backup File

1. Perform steps 1 to 3 in “Displaying the Contacts List” on page 38.
2. Press  [Options] to display the Options menu.
3. Press  or  to highlight “Advanced”, then press  or  [Select] to select.
4. Press  or  to highlight “Delete Backup File”, then press  to select.
5. Enter your handset code, then press .  
A confirmation message is displayed.
6. Press  [Yes].  
To cancel deletion, press  [No] in step 6.

## Memory Status

This function helps you to check the number of entries stored in the Contacts List.

1. Perform steps 1 to 3 in “Displaying the Contacts List” on page 38.
2. Press  [Options] to display the Options menu.
3. Press  or  to highlight “Memory Status”, then press  or  [Select] to select.

You can check the memory status of the SIM card and handset.

## Speed Dial List

You can set a maximum of 9 phone numbers in the Speed Dial List.

### Setting Contacts List entries in the Speed Dial List

1. Search for the desired Contacts List entry and display the details screen.  
For details on searching through Contacts List entries, see “Finding a Name and Number” on page 43.
2. Press ▲ or ▼ to highlight the phone number you wish to set in the Speed Dial List.
3. Press ▢ [Options] to display the Options menu.
4. Press ▲ or ▼ to highlight “Add to Speed Dial”, then press ● or ▢ [Select] to select.
5. Press ▲ or ▼ to highlight the number you wish to set, then press ● to select.

#### Tip

- The nine digit keys correspond to list numbers.

### Viewing the Speed Dial List

For details on viewing the speed dial list, see “Speed Dial List” on page 150.

For details on how to use the speed dial list, see “Speed Dialling” on page 24.

## Sending Messages

1. Search for the desired Contacts List entry and display the details screen.  
For details on searching through Contacts List entries, see “Finding a Name and Number” on page 43.
2. Press ▲ or ▼ to highlight the desired phone number or e-mail address of the recipient.
3. Press ▢ [Options] to display the Options menu.
4. Press ▲ or ▼ to highlight “Create Message”, then press ● or ▢ [Select] to select.
5. Press ▲ or ▼ to highlight “Multimedia” or “Text”, then press ● to select.  
If you have moved the cursor to the “E-mail” field after step 1, “Multimedia” is selected automatically.
6. Enter your message.  
For details on creating a message, see “Creating a New MMS” on page 66 or “Creating a New SMS” on page 78.

## Swapping Location Number of the Phone Number

This function is only for entries stored on the SIM card.

1. Perform steps 1 to 3 in “Displaying the Contacts List” on page 38.
2. Press ▲ or ▼ to scroll through list for selecting the desired name, then press ● to select.
3. Press ▲ or ▼ to highlight the desired phone number.
4. Press ⏏ [Options] to display the Options menu.
5. Press ▲ or ▼ to highlight “Swap”, then press ● or ⏏ [Select] to select.
6. Enter the location number you wish to swap, then press ● to select.

## **Camera (M 5)**

Your phone has an integrated digital camera.

This allows you to take and send pictures or video clips wherever you are.

### **Take Picture (M 5-1)**

Put the phone into the digital camera mode to take a picture.

Pictures are saved in JPEG format in the following five picture sizes.

XXL: 858 × 1144 dots

XL: 768 × 1024 dots

L: 480 × 640 dots

M: 240 × 320 dots

S: 120 × 160 dots









You can send the pictures registered in the handset memory or memory card with your message.

#### **Note**

- *Large MMS messages may cause the size of attached pictures to be reduced.*

### **Selecting the Memory**

When using the memory card, you can choose the memory before taking pictures.

1. In digital camera mode, press  [Options].  
The Options menu is displayed.
2. Press  or  to highlight “Save New Pictures to”, then press  or  [Select] to select.
3. Press  or  to highlight “Handset Memory”, “Memory Card” or “Choice”, then press  to select.

## Taking Pictures

1. Press to display the Main menu.
2. Press , , , or to highlight "Camera", then press to select.
3. Press or to highlight "Take Picture", then press to select.  
The preview is displayed through the main display.
4. Press or the side-down key to take the picture.  
The shutter sounds and the still image of the taken picture is displayed.
5. Press [Save].  
If you have selected "Choice" when saving, the memory card is not inserted, or memory has run out, press or to highlight "Save to Handset" or "Save to Card", then press .  
"Saving (file name) to My Stuff..." is displayed, then the picture is registered.  
If you wish to send a picture by multimedia message after taking the picture, press before step 5.
6. Press to return to stand-by.

### Tip

- Pressing during stand-by also activates digital camera mode.

- To leave digital camera mode without registering the taken picture after step 4, press and then press [Yes].
- When the distance to the subject is approximately 5 cm, set the macro switch to the macro position (). When the distance to the subject is approximately 40 cm or more, set the macro switch to the normal position ().

### To Switch the Viewfinder

You can switch the viewfinder from the main display to the external display for taking a self-portrait.

Press when the preview is displayed through the main display.

Each time you press , the viewfinder switches between the external display and the main display. When you use the external display as the viewfinder, the taken pictures are saved automatically.

## Taking Close-up Pictures

1. In digital camera mode, set the macro switch to the macro position (🌸).
2. Press ● or the side-down key to take the picture.  
To cancel macro mode, set the macro switch to the normal position (👤).

## Using the Zoom Function

Press ◀ or ▶ to change the zooming ratio.

### Note

- When “Picture Size” is set to “S”, the zoom function has 20 steps.
- When “Picture Size” is set to “M”, the zoom function has 10 steps.
- When “Picture Size” is set to “L”, the zoom function has 5 steps.
- When “Picture Size” is set to “XXL” or “XL”, you cannot use the zoom function.

## Selecting the Picture Size

1. In digital camera mode, press ▢ [Options].  
The Options menu is displayed.
2. Press ▲ or ▼ to highlight “Picture Size”, then press ● or ▢ [Select] to select.

3. Press ▲ or ▼ to highlight the picture size, then press ● to select.

## Selecting the Picture Quality

1. In digital camera mode, press ▢ [Options].  
The Options menu is displayed.
2. Press ▲ or ▼ to highlight “Picture Quality”, then press ● or ▢ [Select] to select.
3. Press ▲ or ▼ to highlight “Normal” or “Fine”, then press ● to select.

## Retaking Pictures

After steps 1 to 4 in “Taking Pictures” on page 52, press ▢ [Cancel].

Further shooting is available.

### Note

- The digital camera uses a CCD sensor. Although this camera has been manufactured to the highest specifications, some pictures may still appear too bright or too dark.
- If the phone has been left in a hot place for a long time before taking or registering a picture, the picture quality may be poor.

### In the Case of No Available Memory

When the number of pictures that can be taken becomes 3 or less, the remaining shots indicator in the upper left of the screen turns red. (The number of pictures that can be taken is approximate.)



Even if the number of pictures that can be taken becomes 0, you can continue to take and save pictures until the message, "Memory full. Please delete some data!" appears. After which, you can choose the memory for saving the picture.

### Meanings of Indicators in Digital Camera Mode

#### Remaining shots indicators



- 123 : Indicates the remaining number of pictures that can be taken.
- \*\*\* : Indicates the remaining number of pictures that can be taken exceeds 999.
- ???: Indicates a memory card is not inserted or cannot be recognized by the phone. (When "Memory Card" is selected for the "Save New Pictures to" option)
- : Indicates setting of "Save New Pictures to" is "Choice".

#### Memory indicators (p. 51)

-  : Indicates the handset memory where the pictures are saved.
-  : Indicates the memory card where the pictures are saved.

#### Flash light indicators (p. 58)

Indicates when the flash light is turned on.

-  : Normal mode
-  : Macro mode

#### Delay timer indicator (p. 56)

-  : Indicates when Timer is set.





### Continuous shooting indicators (p. 57)



When pictures are taken in continuous shooting mode, these indicators appear on the screen.



\* When delay timer and continuous shooting functions are simultaneously set, “” is displayed instead.

### Picture size indicators (p. 53)

	XXL: 858 × 1144 dots
	XL: 768 × 1024 dots
	L: 480 × 640 dots
	M: 240 × 320 dots
	S: 120 × 160 dots

### Picture quality indicators (p. 53)



Indicates the quality (normal or fine) of the picture to be taken.

	: Fine
	: Normal

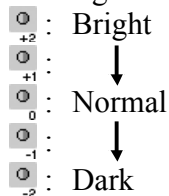
### Picture brightness (exposure level) indicators (p. 56)



### Zooming ratio indicators (p. 53)

 ...  : Indicates the magnification.



## Making Adjustments According to Lighting Conditions







### To Adjust the Brightness of the Picture

Press ▲ or ▼ to adjust the brightness of the picture.

Once the phone has returned to the stand-by screen the brightness settings return to default.

### Viewing the Taken Pictures

Taken pictures in the handset memory or in the memory card can be viewed.







1. In digital camera mode, press  [Options].  
The Options menu is displayed.
2. Press ▲ or ▼ to highlight “My Pictures”, then press  or  [Select] to select.
3. Press ▲ or ▼ to highlight the desired memory, then press  to select.  
The list of pictures is displayed.
4. Press ▲ or ▼ to highlight the file name you wish to view, then press  to select.  
The selected picture is displayed.
5. Once you have finished, press  [Back] to return to the list.

### Tip







- Your pictures are given file names which are “pictureNNN.jpg” for the handset memory, or “pictureNNNNN.jpg” for the memory card (NNN or NNNNN is a consecutive number).  
The file name (without an extension), date and size of your pictures are displayed in the list.

## Using the Timer (Delay Timer)











### To Take a Picture with the Delay Timer

1. In digital camera mode, press  [Options].  
The Options menu is displayed.
2. Press ▲ or ▼ to highlight “Delay Timer”, then press  or  [Select] to select.
3. Press ▲ or ▼ to highlight “On”, then press  to select.  
“” or “” is displayed on the screen and the phone returns to digital camera mode.
4. Press  or the side-down key to start the delay timer.  
10 seconds after the timer sounds, the shutter sounds, and the camera takes a picture.

### Note









- Whilst the delay timer is operating, the flash light and the indicator flash.
- If  or the side-down key is pressed whilst the delay timer is operating, the picture is taken instantly.
- The zoom function with  or , or brightness adjustment of the picture with  or , is unavailable whilst the delay timer is operating.
- If you wish to stop taking pictures with the timer, press  [Cancel] whilst the delay timer is operating.

### Cancelling the Delay Timer

1. Press  [Options] whilst the delay timer setting is on. The Options menu is displayed.
2. Press  or  to highlight “Delay Timer”, then press  or  [Select] to select.
3. Press  or  to highlight “Off”, then press  to select.  
“” or “” goes off.

### Continuous Shooting

Four pictures are taken in succession. Auto Shooting and Manual Shooting are available.

1. In digital camera mode, press  [Options]. The Options menu is displayed.
2. Press  or  to highlight “Continuous Shooting”, then press  or  [Select] to select.
3. Press  or  to highlight “Auto Shooting” or “Manual Shooting”, then press  to select. To cancel Continuous Shooting, select “Off”.
4. Press  or the side-down key to start continuous shooting.

Auto Shooting: Four pictures are taken in a row by pressing  or the side-down key.

Manual Shooting: Pictures are taken one by one by pressing  or the side-down key.

When the Continuous Shooting is completed, the taken pictures are saved automatically.















To stop Continuous Shooting, press  [Cancel].

### Note

- When “Picture Size” is set to “XXL”, “XL” or “L”, you cannot use the Continuous Shooting function.
- When you select a frame for taking pictures, you cannot use the Continuous Shooting function.
- Delay timer cannot be used with the Manual Shooting setting.

### Selecting a Frame









You can select the frame from preset patterns. You can also select a frame in the handset memory or in the memory card.

1. In digital camera mode, press  [Options].  
The Options menu is displayed.
2. Press  or  to highlight “Add Frame”, then press  or  [Select] to select.
3. Press  or  to highlight “Preset Frames” or “My Pictures”, then press  to select.  
If you have selected “My Pictures”, press  or  to highlight “Handset Memory” or “Memory Card”, then press  to select.
4. Press  or  to highlight the frame you wish to use, then press  to select.  
The selected frame is confirmed on the display.
5. Press .



### Note

- When “Picture Size” is set to “XXL”, “XL” or “L”, you cannot use the Frame function.
- When you activate the Continuous Shooting function, you cannot use the Frame function.
- Only the images of PNG format can be selected as the frame if you select “My Pictures” in step 3.









### Selecting Light Colour

1. In digital camera mode, press  [Options].  
The Options menu is displayed.
2. Press  or  to highlight “Light Colour”, then press  or  [Select] to select.
3. Press  or  to highlight the desired colour, then press  to select.  
To turn off the flash light, select “Off”.

### Tip









- Each time  or the side-up key is pressed, the status of the flash light changes as follows.  
Off → On (brightness for normal mode:  Light) → On (brightness for macro mode:  Light) → Off
- If you do not operate your phone for approximately one minute, the flash light turns off automatically to save the power.

### Selecting the Shutter Speed

1. In digital camera mode, press  [Options].  
The Options menu is displayed.
2. Press  or  to highlight “Shutter Speed”, then press  or  [Select] to select.
3. Press  or  to highlight the desired shutter speed, then press  to select.  
“Fast” is suited for moving objects and “Slow” is suited for night photography.

### Selecting the Shutter Sound

You can select the shutter sound from 3 preset patterns.

1. In digital camera mode, press  [Options].  
The Options menu is displayed.
2. Press  or  to highlight “Shutter Sound”, then press  or  [Select] to select.
3. Press  or  to highlight the desired sound, then press  to select.  
To play back the shutter sound, press  [Play] in step 3.

### Sending Pictures

To send your picture to another phone or e-mail address, see “Sending Messages” on page 97 for instructions.

### Deleting Pictures

See “Deleting a Picture” on page 98 for instructions.

### Record Video (M 5-2)









Put the phone into the video camera mode to record a video.

You can send video clips registered in the handset memory or memory card with your message.

Video clips are saved in “.3gp” format.











### Selecting the Memory

When using the memory card, you can choose the memory before recording video clips.

1. In video camera mode, press  [Options].  
The Options menu is displayed.
2. Press  or  to highlight “Save New Videos to”, then press  or  [Select] to select.
3. Press  or  to highlight “Handset Memory”, “Memory Card” or “Choice”, then press  to select.

## Recording Video Clips



Sound can be recorded with the video clip.

1. Press  to display the Main menu.
2. Press , ,  or  to highlight “Camera”, then press  to select.
3. Press  or  to highlight “Record Video”, then press  to select.  
The preview is displayed through the main display.
4. Press  or the side-down key to start recording the video clip.

The sound for recording the video clip occurs.

If you press  or the side-down key again, or when the recording is completed, the sound for ending the video clip recording occurs and the display transits to step 5.

5. Press  or  to highlight “Save”, then press  to select.

If you have selected “Choice” when saving, the memory card is not inserted, or memory has run out, press  or  to highlight “Save to Handset” or “Save to Card”, then press .

“Saving (file name) to My Stuff...” is displayed, then the video clip is registered.

If you preview a video clip before saving, select “Preview” in step 5.

If you wish to send a video clip by multimedia message after recording the video clip, select “Save and Send” in step 5.

### To Switch the Viewfinder

Press  when the preview is displayed through the main display.

Each time you press , the viewfinder switches between the external display and the main display.

### Recording Close-up Video Clips

1. In video camera mode, set the macro switch to the macro position (🌸).
2. Press ● or the side-down key to start recording the video clip.

To cancel macro mode, set the macro switch to the normal position (👤).

### Using the Zoom Function

Zooming ratio can be altered approximately up to 3.5 times in 10 steps. Press 🔍 or 🔍 to change the zooming ratio.

### Selecting Video Quality

1. In video camera mode, press ⏏ [Options].  
The Options menu is displayed.
2. Press 🔍 or 🔍 to highlight “Video Quality”, then press ● or ⏏ [Select] to select.
3. Press 🔍 or 🔍 to highlight “Normal” or “Fine”, then press ● to select.

### Selecting the Recording Time Mode

You can select the recording time mode.

1. In video camera mode, press ⏏ [Options].  
The Options menu is displayed.
2. Press 🔍 or 🔍 to highlight the “Record Time”, then press ● or ⏏ [Select] to select.
3. Press 🔍 or 🔍 to highlight “Extended Video” or “For Message Sending”, then press ● to select.

#### Note

- If “For Message Sending” is selected, the size of the video clip that can be recorded depends on the message size set in MMS settings (p. 77).
- “Save and Send” is not displayed after recording in extended video mode.

### In the Case of No Available Memory

When the number of video clips that can be recorded becomes 3 or less, the remaining sets indicator in the upper left of the screen turns red. (The number of sets that can be recorded is approximate.)

Even if the number of video clips that can be recorded becomes 0, you can continue to record and save video clips until the message, “Memory full. Please delete some data!” appears. After which, you can choose the memory for saving the video clip.

### Meanings of Indicators in Video Camera Mode

#### Remaining sets indicator

- 123 : Indicates the remaining sets of video clips that can be recorded.
- \*\*\* : Indicates the remaining number of video clips that can be recorded exceeds 999.
- ??? : Indicates a memory card is not inserted or cannot be recognized by the phone. (When “Memory Card” is selected for the “Save New Videos to” option)
- : Indicates setting of “Save New Videos to” is “Choice”.

#### Flash light indicators (p. 65)

Indicates when the flash light is turned on.

 : Normal mode

 : Macro mode

#### Delay timer indicator (p. 64)

 : Indicates when Timer is set.

#### Record time indicators

 : Indicates when the phone is in message sending mode.

 : Indicates when the phone is in extended video mode.

#### Video quality indicators (p. 61)



Indicates the quality (normal or fine) of the video clip to be recorded.



 : Fine

 : Normal



#### Video brightness (exposure level) indicators

 : Bright

 :  
↓  
 : Normal

↓  
 :  
↓  
 : Dark

#### Zooming ratio indicators (p. 61)

 .....  : Indicates the magnification.

## Making Adjustments According to Lighting Conditions

### To Adjust the Brightness of the Video Clips

Press ▲ or ▼ to adjust the brightness of the video clip. Once the phone has returned to the stand-by screen, the brightness settings return to default.

### Viewing Recorded Video Clips

Recorded video clips in the handset memory or memory card can be viewed.

1. In video camera mode, press ⏏ [Options].
2. Press ▲ or ▼ to highlight “My Videos”, then press ● or ⏏ [Select] to select.
3. Press ▲ or ▼ to highlight “Handset Memory” or “Memory Card”, then press ● to select.

The list of video clips is displayed.

4. Press ▲ or ▼ to highlight the file name you wish to view, then press ● to select.
5. Press ●.

The selected video clip is played back.

To pause playback, press ●.

To resume playback, press ● again.

To stop playback, press ⏏ [Back].

To display the video clip in actual size, press ⏏ [×1].

6. Once you have finished, press ⏏ [Back] to return to the list.











### Tip

- Your video clips are given file names such as “videoNNN.3gp” for the handset, or “videoNNNNN.3gp” for the memory card (NNN or NNNNN is a consecutive number). The file name (without an extension), date and size of your video clips are displayed in the list.
- If the video clip has been recorded with sound, the volume can be adjusted by pressing ▲ or ▼, or the side-up or side-down key.
- The volume varies depending on the Ringer Volume settings (p. 139). The volume is 0 when “Ringer Volume” is set to “Silent” and 1 when set to “Step Tone”.









## Using the Timer (Delay Timer)

### To Record a Video Clip with the Timer









1. In video camera mode, press  [Options].  
The Options menu is displayed.
2. Press  or  to highlight “Delay Timer”, then press  or  [Select] to select.
3. Press  or  to highlight “On”, then press  to select.  
“” is displayed on the screen and the phone returns to video camera mode.
4. Press  or the side-down key to start the delay timer.  
10 seconds after the timer sounds, the camera starts recording the video clip.

### Note









- *Whilst the delay timer is operating, the flash light and the indicator flash.*
- *If  or the side-down key is pressed whilst the delay timer is operating, the video clip is recorded instantly.*
- *The zoom function with  or , or brightness adjustment of the video with  or , is unavailable whilst the delay timer is operating.*

- *If you wish to stop recording video clips with the timer, press  [Cancel] whilst the delay timer is operating.*









### Cancelling the Delay Timer

1. Press  [Options] whilst the delay timer setting is on.  
The Options menu is displayed.
2. Press  or  to highlight “Delay Timer”, then press  or  [Select] to select.
3. Press  or  to highlight “Off”, then press  to select.  
“” goes off.



### Recording Video Clips with Sound

1. In video camera mode, press  [Options].  
The Options menu is displayed.
2. Press  or  to highlight “Voice Record”, then press  or  [Select] to select.
3. Press  or  to highlight “On”, then press  to select.  
To cancel recording video clips with sound, select “Off” in step 3.

## Selecting Light Colour

1. In video camera mode, press  [Options].  
The Options menu is displayed.
2. Press  or  to highlight “Light Colour”, then press  or  [Select] to select.
3. Press  or  to highlight the desired colour, then press  to select.  
To turn off the flash light, select “Off”.

### Tip

- Each time  or the side-up key is pressed, the status of the flash light changes as follows.  
Off → On (brightness for normal mode: ) → On (brightness for macro mode: ) → Off
- If you do not operate your phone for about one minute, the flash light turns off automatically to save power.

## Sending Video Clips

To send your video clips to another phone or e-mail address, see “Sending Messages” on page 107 for instructions.

## Deleting Video Clips

See “Deleting a Video Clip File” on page 108 for instructions.

## Messages (M 4)

Your phone allows you to send and receive text messages or multimedia messages and to receive WAP alerts.

### Multimedia (MMS) (M 4-2)







#### About Multimedia Messaging



Multimedia Messaging Service (MMS) allows you to send and receive multimedia messages with graphical images, photographs, sound, animations or video clips attached.

#### Note





- **Some MMS functions may not always be available depending on your network. Contact your network operator for more information.**
- *MP3 sound files cannot be sent attached to a message.*

#### Creating a New MMS (M 4-2-1)

1. Press  during stand-by.
2. Press  or  to highlight “Multimedia”, then press .
3. Press  or  to highlight “Create Message”, then press .

4. Enter your message, then press .
5. Enter the phone number or e-mail address of the recipient, then press .

If you wish to select a phone number or e-mail address in the Contacts List, search for the desired Contacts List entry.

Press  or  to display the Contacts List. Then press  or  to highlight the desired entry, then press  to select. For details on searching the Contacts List entries, perform steps 2 to 4 in “Finding a Name and Number” on page 43.

6. Press  or  to highlight “Send”, then press  to select.

The message is put in the Outbox and sent.

After the message is sent, the message is moved to the Sent box.

#### Note

- *The current message size displayed whilst you are creating the message is an approximation.*
- *If a message cannot be sent for some reason, the message stays in the Outbox and “” is displayed on the stand-by screen.*

### To Enter the Subject of the Message

1. Perform steps 1 to 5 in “Creating a New MMS” on page 66.
2. Press ▲ or ▼ to highlight “Subject”, then press ● to select.
3. Enter the subject of your message, then press ●.

#### **Note**

- *This phone allows you to enter up to 40 characters as the subject, and enter up to 20 addresses (for To and Cc). However, these may be limited depending on your network. In this case, you may not be able to send MMS. Contact your network operator for more information.*

### To Send a Message Template MMS

Your phone provides message templates with an image and voice attachment that help you create easily.

1. Perform steps 1 to 3 in “Creating a New MMS” on page 66.
2. Press [Options] to display the Options menu.
3. Press ▲ or ▼ to highlight “Message Template”, then press ● or [Select] to select.  
A confirmation screen asking whether you wish to discard the current text is displayed.
4. Press [Yes] to discard.  
To cancel, press [No] in step 4.
5. Press ▲ or ▼ to highlight a template you wish to send, then press ● to select.
6. Perform steps 4 to 6 in “Creating a New MMS” on page 66.

#### **Note**

- *Selecting “Message Template” deletes messages or images you have entered or attached. To prevent deletion, select “Message Template” first, then enter messages.*

### To Add Recipients

1. Perform steps 1 to 5 in “Creating a New MMS” on page 66.
2. Press ▲ or ▼ to highlight “Add Contact”, then press ● to select.
3. Press ▲ or ▼ to highlight “To” to add recipients or “Cc” to send a copy of this MMS to other recipients, then press ● to select.
4. Press ▲ or ▼ to highlight a desired number from the list, then press ● to select.
5. Enter the phone number or e-mail address of the other recipients, then press ●.
6. Press ⏪ [Back] twice.

### To Use the Text Template

For details on creating text templates, see page 109.

1. Perform steps 1 to 3 in “Creating a New MMS” on page 66.
2. Press ▲, ▼, ◀ or ▶ to move the cursor to the point you wish to insert the template.
3. Press ⏪ [Options] to display the Options menu.
4. Press ▲ or ▼ to highlight “Text Template”, then press ● or ⏩ [Select] to select.

5. Press ▲ or ▼ to highlight the desired template from the list, then press ● to select.

### To Save a Message in the Drafts Box













You can save a message in the Drafts box temporarily and send it later.

1. Perform steps 1 to 5 in “Creating a New MMS” on page 66.
2. Press ▲ or ▼ to highlight “Save to Drafts”, then press ● to save the message in the Drafts box.











### Note

- You can send it later following the instructions in “Sending a Message in the Drafts Box” on page 71.

## Turning the Slide Show Setting On or Off

1. Press  during stand-by.
2. Press  or  to highlight “Multimedia”, then press  to select.
3. Press  or  to highlight “Settings”, then press  to select.
4. Press  or  to highlight “Slide Show”, then press  to select.
5. Press  or  to highlight “On” or “Off”, then press  to select.

### If You Select “On”

- You can create messages which have up to 10 slides. Each slide can contain one picture, one sound file and up to 1000 characters of text (up to the message total 30 Kbytes or 100 Kbytes limit).
- If you wish to add a slide to a single slide:
  1. Press  [Options] to display the Options menu.
  2. Press  or  to highlight “Add Slide”, then press  or  [Select] to select.If you wish to perform slide operations for multiple slides:
  1. Press  [Options] to display the Options menu.
  2. Press  or  to highlight “Slide Control”, then press  or  [Select] to select.The slide control options available are:

*Add:* To add a new slide.

*Remove:* To remove the active slide.

*Previous:* To navigate to the previous slide.

*Next:* To navigate to the next slide.







- EVA (e-Animation file) and video clip data cannot be attached as slide data to the message.











### If You Select “Off”

- You can attach a maximum of 20 pictures, sounds or video clips and up to 2000 characters of text (up to the message total 30 Kbytes or 100 Kbytes limit).

## Inserting Attached Data

You can send pictures, sounds and video clips saved in the handset memory attached to multimedia messages. When attaching video clips, “Slide Show” must be set to “Off”.









1. Press  during stand-by.
2. Press  or  to highlight “Multimedia”, then press  to select.
3. Press  or  to highlight “Create Message”, then press  to select.





4. Press  [Options] to display the Options menu.
5. Press  or  to highlight “Picture”, “Sound” or “Video”, then press  or  [Select] to select.
6. Press  or  to highlight “Handset Memory” or “Memory Card”, then press  to select.
7. Press  or  to highlight the file name you wish to attach, then press  to select.

The selected picture/sound/video clip is attached. When attaching is complete, press  [Back] to return to the message creation screen.









#### To Add Attached Data

You can perform the following with the slide show setting off.



















1. Perform steps 1 to 5 in “Inserting Attached Data” on page 69.  
The list of attached data is displayed.
2. Press  [Options] to display the Options menu.
3. Press  or  to highlight “Add Picture”, “Add Sound” or “Add Video”, then press  or  [Select] to select.
4. Press  or  to highlight “Handset Memory” or “Memory Card”, then press  to select.

5. Press  or  to highlight the file name you wish to attach, then press .
6. Press  [Back].

#### To Remove Attached Data

1. Perform steps 1 to 5 in “Inserting Attached Data” on page 69.  
The list of attached data is displayed.
2. Press  or  to highlight the file name you wish to remove, then press  [Options].
3. Press  or  to highlight “Remove”, then press  or  [Select] to select.
4. Press  [Yes].  
To cancel removal, press  [No] in step 4.

## Sending a Message in the Drafts Box

1. Press  during stand-by.
2. Press  or  to highlight “Multimedia”, then press  to select.
3. Press  or  to highlight “Drafts”, then press  to select.
4. Press  or  to highlight the message you wish to send in the Drafts box, then press  [Options].  
The Options menu is displayed.
5. Press  or  to highlight “Edit Message”, then press  or  [Select] to select.
6. Modify the message, then press .
7. Modify the phone number or e-mail address of the recipients, then press .
8. Press  or  to highlight “Send”, then press  to select.

### Note













- You cannot modify a Slide Show message that is created on another phone as shown in step 6. Go to step 7.

## Reading MMS

Messages you receive are stored in the Inbox.

### Incoming Messages

The MMS indicator () will appear when you are receiving an incoming message.

1. Press  during stand-by.
2. Press  or  to highlight “Multimedia”, then press  to select.
3. Press  or  to highlight “Inbox”, then press  to select.  
Messages that are marked with a clip denote mails with attachments.
4. Press  or  to highlight the message you wish to view, then press  to select.  
The message is displayed.
5. Press  or  to scroll the screen to read the message.
6. When you finish viewing, press .



### To Check the Sender and Receiver Phone Number or E-mail Address

1. Perform steps 1 to 3 in “Incoming Messages” on page 71.
2. Press ▲ or ▼ to highlight the desired message, then press ⏏ [Options] to display the Options menu.
3. Press ▲ or ▼ to highlight “Details”, then press ● or ⏏ [Select] to select.  
The sender’s phone number or e-mail address, time and date stamp, subject and size are displayed.

### Replying to a Message from the Sender from the Inbox

1. Press ⏏ during stand-by.
2. Press ▲ or ▼ to highlight “Multimedia”, then press ● to select.
3. Press ▲ or ▼ to highlight “Inbox”, then press ● to select.
4. Press ▲ or ▼ to highlight the message to which you wish to reply.

5. Press ⏏ [Options] to display the Options menu.
6. Press ▲ or ▼ to highlight “Reply”, then press ● or ⏏ [Select] to select.
7. Enter your message.  
For details on entering characters, see “Entering Characters” on page 32.
8. Press ●.  
The phone number or e-mail address of the recipient is automatically filled in the sender’s phone number or e-mail address.
9. Press ●.  
The subject field is automatically filled in with the original subject preceded by “Re:”.
10. Press ▲ or ▼ to highlight “Send”, then press ● to select.

#### **Tip**

- You can reply to a message to all addresses of selected messages by selecting “Reply All” in step 6.

## Forwarding a Message

1. Perform steps 1 to 3 in “Replying to a Message from the Sender from the Inbox” on page 72.
2. Press ▲ or ▼ to highlight the message you wish to forward.
3. Press ⏏ [Options] to display the Options menu.
4. Press ▲ or ▼ to highlight “Forward”, then press ● to select.
5. Enter the phone number or e-mail address of the recipient, then press ●.

If you wish to select the phone number or e-mail address in the Contacts List, search for the desired Contacts List entry.

Press ▲ or ▼ to display the Contacts List. Then press ▲ or ▼ to highlight the desired entry, then press ● to select. For details on searching the Contacts List entries, perform steps 2 to 4 in “Finding a Name and Number” on page 43.

6. Press ▲ or ▼ to highlight “Send”, then press ● to select.

## Note

- When a message with attached data is forwarded the data is also sent. However, if there is any data which the phone recognises as having copyright, then it will not be sent.
- The “Subject” field is automatically filled in with the original subject preceded by “Fw:”. The original message cannot be changed.

## Modifying a Message

1. Perform steps 1 to 3 in “Replying to a Message from the Sender from the Inbox” on page 72.
2. Press ▲ or ▼ to highlight the message you wish to modify.
3. Press ⏏ [Options] to display the Options menu.
4. Press ▲ or ▼ to highlight “Edit Message”, then press ● or ⏏ [Select] to select.
5. Modify the message, then press ●.
6. Enter the phone number or e-mail address of the recipient, then press ●.
7. Press ▲ or ▼ to highlight “Send”, then press ● to select.

## Note

- Messages cannot be edited if they contain particular data such as Slide Show, XHTML, copyrights or an unknown format.

### Storing the Phone Number or E-mail Address of a Sender in the Contacts List

1. Perform steps 1 to 5 in “Replying to a Message from the Sender from the Inbox” on page 72.
2. Press ▲ or ▼ to highlight “Save to Contacts”, then press ● to select.  
For details on entering a name, see “Add New Contact” on page 39.

### Retrieving MMS

When “✉” is in the Inbox, the following can be done.

1. Perform steps 1 and 2 in “Creating a New MMS” on page 66.
2. Press ▲ or ▼ to highlight “Inbox”, then press ● to select.
3. Press ▲ or ▼ to highlight the alert you wish to download.
4. Press ⏏ [Options] to display the Options menu.
5. Press ▲ or ▼ to highlight “Download”, then press ● or ⏏ [Select] to select.

#### Tip

- You can press ● instead of steps 4 and 5 to start downloading.

### Re-sending a Message in the Outbox

If a message cannot be sent for some reason, the message stays in the Outbox. Messages in the Outbox can be resent.

1. Perform steps 1 and 2 in “Creating a New MMS” on page 66.
2. Press ▲ or ▼ to highlight “Outbox”, then press ● to select.
3. Press ▲ or ▼ to highlight the message you wish to re-send in the Outbox, then press ⏏ [Options].
4. Press ▲ or ▼ to highlight “Re-send”, then press ● or ⏏ [Select] to select.

### Confirming Arrival of Delivery Report

1. Perform steps 1 and 2 in “Creating a New MMS” on page 66.
2. Press ▲ or ▼ to highlight “Sent”, then press ● to select.
3. Press ▲ or ▼ to highlight the message of which you wish to confirm arrival of delivery report, then press ▢ [Options] to display the Options menu.
4. Press ▲ or ▼ to highlight “Delivery Report”, then press ● or ▢ [Select] to select.

This menu is available only for sent messages that have the “Delivery Report” set to “On”. For details on selecting “Delivery Report”, see “Setting Up MMS” on page 76.

### Deleting a Message

1. Perform steps 1 and 2 in “Creating a New MMS” on page 66.
2. Press ▲ or ▼ to highlight “Inbox”, “Sent”, “Drafts” or “Outbox”, then press ● to select.
3. Press ▲ or ▼ to highlight the message you wish to delete, then press ▢ [Options]. The Options menu is displayed.
4. Press ▲ or ▼ to highlight “Delete”, then press ● or ▢ [Select] to select.
5. Press ▲ or ▼ to highlight “One Message”, then press ● to select.
6. Press ▢ [Yes].  
The selected message is deleted.  
To cancel deletion, press ▢ [No] in step 6.

#### Note

- You cannot delete locked messages.

#### Tip

- To delete all messages in the selected folder, press ▲ or ▼ to highlight “All Messages”, then press ● to select in step 5.

## To Lock Message

1. Perform steps 1 and 2 in “Creating a New MMS” on page 66.
2. Press ▲ or ▼ to highlight “Inbox” or “Sent”, then press ● to select.
3. Press ▲ or ▼ to highlight the message you wish to lock, then press ▢ [Options].  
The Options menu is displayed.
4. Press ▲ or ▼ to highlight “Lock/Unlock”, then press ● or ▢ [Select] to select.

## Making a Call to the Sender of a Message

You can make a call to the sender of a message in the Inbox whose address (From) is the phone number.

1. Perform steps 1 to 3 in “Replying to a Message from the Sender from the Inbox” on page 72.
2. Press ▢ [Options] to display the Options menu.
3. Press ▲ or ▼ to highlight “Call Sender”, then press ● or ▢ [Select] to select.

### Tip

- You can press ▢ to make a call instead of steps 2 and 3.

## Setting Up MMS

1. Press ▢ during stand-by.
2. Press ▲ or ▼ to highlight “Multimedia”, then press ● to select.
3. Press ▲ or ▼ to highlight “Settings”, then press ● to select.
4. Press ▲ or ▼ to highlight the desired item, then press ● to select.

The items available are:

- Roam. Download:  
Defers MMS download method when roaming outside of your network.
- Delivery Rep. Allow:  
Enables Delivery Report when receiving a message which applies to the Delivery Report function.
- Anonymous Reject:  
Rejects a messages from an unknown or empty address name.
- Auto Delete:  
Deletes the oldest message automatically, when the Inbox, Sent or Both (Inbox and Sent) is full.

- Slide Show:  
Enables Slide Show when sending a message.
  - Message Size:  
Sets the maximum message size to be allowed in sending.
  - Advanced
    - Priority:  
Prioritises composed messages.
    - Delivery Report:  
Enables Delivery Report.
    - Expiry Time:  
Sets Expiry Time for a message to be stored in the Server.
    - Sender Visibility:  
Displays the information about the sender.
    - Slide Interval:  
Sets the slide display time when sending a message.
5. Change each item.
6. When you finish setting, press  [Back].

## **Text (SMS) (M 4-3)**

### **About Text Messaging**

The Short Message Service (SMS) allows you to send text messages of up to 1024 characters to other GSM users.









### **To Use SMS with Your Phone**

Messages longer than 160 characters may be composed. During sending, the messages are split. If the receiver has a suitable phone the messages recombines during reception, if not your message appears as a number of separate 152 characters messages.

You can send or receive SMS even if you are talking on the phone.













You can also use Text Templates to help you compose SMS.

### Creating a New SMS (M 4-3-1)





1. Press  during stand-by.
2. Press  or  to highlight “Text”, then press  to select.
3. Press  or  to highlight “Create Message”, then press  to select.
4. Enter your message.  
For details on entering characters, see “Entering Characters” on page 32.
5. Press .

### To Use the Text Template









For details on creating text templates, see “Text Templates” on page 109.

1. Perform steps 1 to 3 in “Creating a New SMS”.
2. On the text entry screen, press , ,  or  to move the cursor to the point you wish to insert the template.
3. Press  [Options] to display the Options menu.
4. Press  or  to highlight “Text Template”, then press  or  [Select] to select.
5. Press  or  to highlight the desired template from the list, then press  to select.

### To Save the Message in the Drafts box





1. Perform steps 1 to 5 in “Creating a New SMS”.
2. Enter the phone number of the recipient, then press .
3. Press  or  to highlight “Save to Drafts”, then press  to select.

### Sending a Message

1. Press  during stand-by.
2. Press  or  to highlight “Text”, then press  to select.
3. Press  or  to highlight “Create Message”, then press  to select.
4. Enter your message.  
For details on entering characters, see “Entering Characters” on page 32.
5. Press .

6. Enter the phone number of the recipient, then press .



If you wish to select the phone number in the Contacts List, search for the desired Contacts List entry.

Press  or  to display the Contacts List. Then press  or  to highlight the desired entry, then press  to select. For details on searching the Contacts List entries, perform steps 2 to 4 in “Finding a Name and Number” on page 43.









7. Press  or  to highlight “Send”, then press  to select.

The phone begins the sending process and the SMS is sent. After the message has been sent, the message is added to the Sent box.

**Note**

- *When you send a message of more than 160 characters, the confirmation message is displayed. Press  [Yes] to send or  [No] to cancel.*

### To Add Recipients

1. Perform steps 1 to 6 in “Sending a Message” on page 78.
2. Press  or  to highlight “Add Contact”, then press  to select.
3. Press  or  to highlight an item number for adding recipient’s phone number, then press  to select.
4. Enter the phone number to add, then press .
5. When adding recipients is complete, press  [Back].



Follow the procedure from step 7 in “Sending a Message” on page 78.





## Reading SMS





### Incoming Messages

The SMS indicator () will appear when an incoming message arrives.







1. When you receive a SMS, press  during stand-by.
2. Press  or  to highlight the message you wish to view.

The sender's phone number and a part of the message are displayed. When the sender's phone number is stored in the Contacts List, the sender's name is displayed instead of the phone number.





Messages are marked with "" denote unread messages. If the Inbox, Sent box or Drafts box is full, "" is displayed. Delete unnecessary messages.

3. Press .
4. Press  or  to scroll the screen to read the message.
5. When you have finished viewing, press .

## Replying to the Sender

1. Perform steps 1 to 3 in "Reading SMS".
  2. Press  [Options] to display the Options menu.
  3. Press  or  to highlight "Reply", then press  or  [Select] to select.
  4. Enter your message.  
For details on entering characters, see "Entering Characters" on page 32.
  5. Press .
- Follow the procedure from step 6 in "Sending a Message" on page 78.







### Calling the Message Sender

1. Perform steps 1 to 3 in “Reading SMS” on page 80.
2. Press  [Options] to display the Options menu.
3. Press  or  to highlight “Call Sender”, then press  or  [Select] to select.



#### Tip

- You can press  to make a call instead of step 2 and 3.













### Forwarding a Message

1. Perform steps 1 to 3 in “Reading SMS” on page 80.
2. Press  [Options] to display the Options menu.
3. Press  or  to highlight “Forward”, then press  or  [Select] to select.
4. Enter the phone number of the recipient, then press .

For details on searching the Contacts List entries, perform steps 1 to 4 in “Finding a Name and Number” on page 43.

5. Press  or  to highlight “Send”, then press  to select.
6. Follow the procedure from step 7 in “Sending a Message” on page 78.  
The phone begins the sending process and the SMS is sent.

### Modifying a Message

1. Perform steps 1 and 2 in “Creating a New SMS” on page 78.
2. Press  or  to highlight “Inbox”, “Sent” or “Drafts”, then press  to select.
3. Press  or  to highlight the message you wish to modify, then press  to select.
4. Press  [Options] to display the Options menu.
5. Press  or  to highlight “Edit”, then press  or  [Select] to select.
6. Modify the message, then press .  
Follow the procedure from step 6 in “Sending a Message” on page 78.

## Deleting a Message

1. Perform steps 1 and 2 in “Creating a New SMS” on page 78.
2. Press ▲ or ▼ to highlight “Inbox”, “Sent” or “Drafts”, then press ● to select.
3. Press ▲ or ▼ to highlight the message you wish to delete, then press ▢ [Options].  
The Options menu is displayed.
4. Press ▲ or ▼ to highlight “Delete”, then press ● or ▢ [Select] to select.
5. Press ▲ or ▼ to highlight “One Message”, then press ● to select.
6. Press ▢ [Yes].  
The selected message is deleted.  
To cancel deletion, press ▢ [No] in step 6.

### Tip

- To delete all messages in the selected folder, press ▲ or ▼ to highlight “All Messages”, then press ● to select in step 5.

## Extracting Phone Numbers from the Received Messages and Making a Call

You can make a call using the phone number embedded in the received SMS message.

1. Perform steps 1 and 2 in “Reading SMS” on page 80.
2. Press ▢ [Options] to display the Options menu.
3. Press ▲ or ▼ to highlight “Extract Numbers”, then press ● or ▢ [Select] to select.  
Telephone numbers embedded in the message are displayed.
4. Press ▲ or ▼ to highlight the number, then press ▢ [Options] to display the Options menu.
5. Press ▲ or ▼ to highlight “Make Call”, then press ● to select.  
To save this phone number in the Contacts List, press ▲ or ▼ to highlight “Save to Contacts”, then press ● to select.  
For details on entering a name, see “Add New Contact” on page 39.













### Tip

- Selecting “Save to Contacts” in step 3 instead allows you to go to the phone number entry screen with the sender’s number entered.

For details on entering a name, see “Add New Contact” on page 39.

### Setting Up SMS (M 4-3-5)







#### To Set Up the Service Centre Address

1. Press  during stand-by.
2. Press  or  to highlight “Text”, then press  to select.
3. Press  or  to highlight “Settings”, then press  to select.
4. Press  or  to highlight “Message Centre”, then press  to select.
5. Enter the centre number.  
If you wish to enter a country code for a message to an international number, press and hold  until a “+” sign is displayed.
6. Press .







### Message Lifetime

This indicates the number of days and hours for which a message you send may remain undelivered to the message recipient.

During this period, the message service centre will continually try to deliver the message to the recipient.

1. Perform steps 1 to 3 in “Setting Up SMS”.
2. Press  or  to highlight “Message Lifetime”, then press  to select.
3. Press  or  to highlight the validity period, then press  to select.

### Message Format

1. Perform steps 1 to 3 in “Setting Up SMS”.
2. Press  or  to highlight “Message Format”, then press  to select.
3. Press  or  to highlight the message format, then press  to select.

### Connection Type

1. Perform steps 1 to 3 in “Setting Up SMS” on page 83.
2. Press ▲ or ▼ to highlight “Connection Type”, then press ● to select.
3. Press ▲ or ▼ to highlight the connection type, then press ● to select.

### Optimisation

When set “On” (default), double-byte characters such as European characters with an accent are converted into single-byte characters and sent.

When “Off”, double-byte characters are sent as displayed.

Please note that you may be charged double for double-byte characters sent in an SMS when Optimisation is set “Off”.

1. Perform steps 1 to 3 in “Setting Up SMS” on page 83.
2. Press ▲ or ▼ to highlight “Optimisation”, then press ● to select.
3. Press ▲ or ▼ to highlight “On” or “Off”, then press ● to select.

### Cell Broadcasts (M 4-7)





You can receive Cell Broadcast messages or general messages such as weather forecasts and traffic reports. This information is broadcast to subscribers in certain network areas.

This function may not be available on all mobile phone networks. Contact your network operator for more information.

#### Enabling/Disabling Cell Broadcasts (M 4-7-1)

















1. Press  during stand-by.
2. Press ▲ or ▼ to highlight “Cell Broadcasts”, then press ● to select.
3. Press ▲ or ▼ to highlight “On/Off”, then press ● to select.
4. Press ▲ or ▼ to highlight “On” to set Cell Broadcasts on or “Off” to set it off, then press ● to select.

### Reading Cell Broadcast Messages (M 4-7-2)

1. When you receive a Cell Broadcast message, press .
2. Press  or  to scroll the screen to read the message.
3. When you finish viewing, press .

### Subscribing to Cell Broadcasts (M 4-7-3)

Select the page of the cell broadcast message that you want.









1. Press  during stand-by.
2. Press  or  to highlight “Cell Broadcasts”, then press  to select.
3. Press  or  to highlight “Settings”, then press  to select.
4. Press  or  to highlight “Set Info Subjects”, then press  to select.
5. Press  or  to highlight “Add/Remove”, then press  to add the channel.
6. Press  or  to highlight the desired page, then press  to select.
7. Press  [Back].

### Tip

- If the desired page is not in the list that appears in step 6, select “Create Subject” in step 5, then enter the subject code to add a page. For details on the subject code, contact your service provider.

### Setting Languages

Allows you to select your preferred language for the cell broadcast message display.

1. Perform steps 1 to 3 in “Subscribing to Cell Broadcasts”.
2. Press  or  to highlight “Language”, then press  to select.  
The current language is displayed.
3. Press .
4. Press  or  to highlight the language you wish to set, then press  to select.
5. Press  [Back] to exit.

## Area Info (M 4-8)







The Area Info is the message information that operators sent to subscribers in certain areas.

When you receive Area Info, the message (area code) is displayed on the stand-by screen.

### *Note*

- *This function may not be available on all mobile phone networks. Contact your network operator for more information.*

### Enabling/Disabling Area Info

1. Press  during stand-by.
2. Press  or  to highlight “Area Info”, then press  to select.
3. Press  or  to highlight “On” or “Off”, then press  to select.

### *Note*

- *If Area Info is set to “On”, the stand-by time will decrease.*

## **Vodafone live! (M 2)**

Your phone is already configured to access Vodafone live! and the mobile internet\*.



Vodafone live! is a new mobile internet portal which is your gateway to a new world of information, games, music and services.

Because your phone uses GPRS, a system that is much faster than previous ways of getting mobile information. Also, the connection is 'always on' which means there is no need to wait for dialling up. You only have to pay for the data you send or receive, not how long you're connected.

\* If you have problems getting connected, please phone Vodafone Customer Support.

Your phone contains a WAP browser used for surfing on the Mobile Internet, where you can get a lot of useful information. Normally, pages are designed for a mobile phone.

Your phone is already setup to Vodafone site for WAP/MMS Settings.



### **Viewing the WAP Browser**







1. Press  during stand-by.

### **To Exit the WAP Browser**

1. Press  to exit the browser.

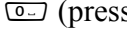
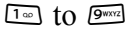

## Navigating a WAP Page

- : Move the highlights around in the screen.
- : Used to execute the option displayed in the lower centre of the screen.
- : Launch browser option menu.
- : Used to select an action displayed in the lower right corner of the screen. Used to access “Vodafone live!” by opening the browser.
-  (press and hold): Used to start the Go to URL.
-  to  (press and hold): Used to start the Bookmark (WAP).
- : Exit (short press)  
Turn off the phone. (press and hold)

## Browser Menu

When you have started browsing, you can reach browsing options by pressing  [Options].

The Browser menu contains the following:







- Select:  
Select the link you wish to see. (“Select” is displayed only when the link is highlighted.)
- Home:  
Go to the homepage you set in the WAP Settings.
- Add bookmark:  
Add the site you are currently browsing to your list of bookmarks.
- View bookmarks:  
See your list of bookmarks.
- Save items:  
Save images, sounds or video clips in the handset memory.
- Go to URL:  
Input the URL of the site you wish to go to.
- History:  
See your history list.

- Forward:  
Move to the next URL in the history list.
- Reload page:  
Refresh the contents of the WAP page.
- Advanced...:
  - Show URL:  
Display the URL of the site you are currently browsing.
  - Save page:  
Save the page you are currently browsing to your list of Snap Shots.
  - Snapshots:  
See your list of Snap Shots.
  - Alert inbox:  
See your list of WAP push messages. You can receive push messages via WAP Services. This means that a service provider sends WAP content to your phone, without any set up.
  - Settings:  
Includes “Downloads”, etc.
  - Security:  
Set the security.
  - Clear...:  
Clear History, cache, etc.









- Restart Browser:  
Restart the browser.

### **Bookmarks**





















To Add a Bookmark

1. Press  [Options] when you are browsing to display the Options menu.
2. Press  or  to highlight “Add bookmark”, then press  or  [Select] to select.
3. Press  to save.





















To Access Bookmarked Pages

1. Press  [Options] when you are browsing to display the Options menu.
2. Press  or  to highlight “View bookmarks”, then press  or  [Select] to select.
3. Press  or  to highlight a bookmark page you wish to access, then press  to select.

### To Edit Bookmarks





















1. Press  [Options] when you are browsing to display the Options menu.
2. Press  or  to highlight “View bookmarks”, then press  or  [Select] to select.
3. Press  or  to highlight “More...”, then press  to select.
4. Press  or  to highlight a bookmark page you wish to edit, then press  [Options] to display the Options menu.
5. Press  or  to highlight “Details”, then press  or  [Select] to select.
6. Edit the title, then press .
7. Edit the URL, then press .
8. Press  or  to highlight “Save”, then press  to save.

### To Delete Bookmarks

1. Press  [Options] when you are browsing to display the Options menu.
2. Press  or  to highlight “View bookmarks”, then press  or  [Select] to select.
3. Press  or  to highlight “More...”, then press  to select.
4. Press  or  to highlight a bookmark page you wish to delete, then press  [Options] to display the Options menu.
5. Press  or  to highlight “Delete”, then press  or  [Select] to select.
6. Press  [Options] to display the Options menu, then press  or  to highlight “OK”, then press  or  [Select] to delete.

## Setting the Hotkeys to Web Page Bookmarks

You can access Web pages quickly by pressing the shortcut keys (hotkeys). Follow the following to assign shortcuts.

1. Press  [Options] when you are browsing to display the Options menu.
2. Press  or  to highlight “View bookmarks”, then press  or  [Select] to select.
3. Press  or  to highlight “More...”, then press  to select.
4. Press  or  to highlight a bookmark page you wish to edit, then press  [Options] to display the Options menu.
5. Press  or  to highlight “Hotkeys”, then press  or  [Select] to select.  
The list of hotkeys is displayed.
6. Press  or  to highlight the number to which you wish to assign hotkeys, then press  to select.  
The list of registered bookmarks is displayed.
7. Press  or  to highlight the desired bookmark, then press  to select.

## My Stuff (M 6)

My Stuff in the handset memory or memory card contains several types of picture, sound and video clip data. Also included in My Stuff are frequently used text message phrases and accessed WAP pages (addresses) which you can use.

### Pictures (M 6-1)

Pictures that are taken by a digital camera or images that are downloaded from mobile Internet sites can be managed.



: Images in PNG format



: Images in JPEG format



: e-Animation file (NEVA)



: Images in GIF format



: Images in BMP format



: Images in WBMP format



: Images in WPNG format

#### Note

- The phone can store approximately 6 Mbytes of data across Pictures, Games & More, Sounds and Videos.















### Viewing Pictures

1. Press to display the Main menu.
2. Press , , , or to highlight "My Stuff", then press to select.
3. Press or to highlight "Pictures", then press to select.
4. Press or to highlight "Handset Memory" or "Memory Card", then press to select.  
The list of pictures is displayed.
5. Press or to highlight the file name you wish to view, then press to select.  
The selected picture is displayed.
6. Once you have viewed the picture, press [Back] to return to the list.

#### Tip

- The memory source indicator (handset: or memory card: ) is displayed so that you can find the memory you are using.

## Using Images as Wallpaper

1. Perform steps 1 to 4 in “Viewing Pictures” on page 92.
2. Press  or  to highlight the file name you wish to use as wallpaper, then press  [Options].  
The Options menu is displayed.
3. Press  or  to highlight “Set as Wallpaper”, then press  or  [Select] to select.
4. Press  or  to highlight “Main Display” or “External Display”, then press  to select.  
The selected picture is displayed.
5. Press , ,  or  to specify the area you wish to display, then press .







### Tip

- Images in jpeg format used as wallpaper are displayed in approximately 260 thousand colours due to software processing.











## Saving to Contacts List

You can use this option only for pictures saved in the handset memory.









1. Perform steps 1 to 4 in “Viewing Pictures” on page 92.

2. Press  or  to highlight the file name you wish to add to Contacts List, then press  [Options].  
The Options menu is displayed.
3. Press  or  to highlight “Add to Contact”, then press  or  [Select] to select.

### When you overwrite existing Contacts List data















4. Press  or  to highlight “Existing Contact”, then press  to select.  
If the picture size exceeds 240 dots in width or 320 dots in height, press , ,  or  to specify the area you wish to display, then press .
5. Press  or  to highlight the data you wish to save to, then press .

### When you save new Contacts List data

4. Press  or  to highlight “New Contact”, then press  to select.  
If the picture size exceeds 240 dots in width or 320 dots in height, press , ,  or  to specify the area you wish to display, then press .  
For details on entering a name, see “Add New Contact” on page 39.

## Editing Pictures















### To Retouch Pictures

1. Perform steps 1 to 4 in “Viewing Pictures” on page 92.
2. Press  or  to highlight the file name you wish to retouch, then press  [Options].  
The Options menu is displayed.
3. Press  or  to highlight “Edit Picture”, then press  or  [Select] to select.
4. Press  or  to highlight “Retouch”, then press  to select.
5. Press  or  to highlight the retouching option you wish to use, then press  to select.  
The selected option is confirmed on the display.
6. Press .

#### Note

- The size of pictures that can be retouched is 52 dots [W] × 52 dots [H] minimum and 240 dots [W] × 320 dots [H] or 320 dots [W] × 240 dots [H] maximum.























### To Add a Frame to Pictures

1. Perform steps 1 to 4 in “Viewing Pictures” on page 92.
2. Press  or  to highlight the file name you wish to add frame to, then press  [Options].  
The Options menu is displayed.
3. Press  or  to highlight “Edit Picture”, then press  or  [Select] to select.
4. Press  or  to highlight “Add Frame”, then press  to select.
5. Press  or  to highlight the frame pattern you wish to use, then press  to select.  
The selected frame is confirmed on the display.
6. Press .

#### Note

- The size of pictures that you can add a frame to is 240 dots [W] × 320 dots [H] or 320 dots [W] × 240 dots [H] maximum.













### To Add Stamps to Pictures

1. Perform steps 1 to 4 in “Viewing Pictures” on page 92.
2. Press  or  to highlight the file name you wish to add stamp to, then press  [Options].  
The Options menu is displayed.
3. Press  or  to highlight “Edit Picture”, then press  or  [Select] to select.
4. Press  or  to highlight “Add Stamps”, then press  to select.
5. Press  [Stamps], then press  or  to highlight the stamp pattern you wish to use, then press  to select.
6. Press , ,  or  to move the cursor to the point you wish to add a stamp.
7. Press  to add the stamp.  
To add more stamps, repeat steps 5 to 7.
8. Press  [End], then press  [Yes].  
To cancel, press  [No] in step 8.

### Note

- The size of pictures that you can add stamps to is 24 dots [W] × 24 dots [H] minimum and 240 dots [W] × 320 dots [H] or 320 dots [W] × 240 dots [H] maximum.

### To Rotate Pictures

1. Perform steps 1 to 4 in “Viewing Pictures” on page 92.
2. Press  or  to highlight the file name you wish to rotate, then press  [Options].  
The Options menu is displayed.
3. Press  or  to highlight “Edit Picture”, then press  or  [Select] to select.
4. Press  or  to highlight “Rotate”, then press  to select.  
The picture is rotated 90° anticlockwise.  
Press  [Rotate] again for another 90°.
5. Press .

### Note

- The size of pictures that you can rotate is 240 dots [W] × 320 dots [H] or 320 dots [W] × 240 dots [H] maximum.



## Copying or Moving Pictures

You can copy or move pictures between the handset memory and memory card.

1. Perform steps 1 to 4 in “Viewing Pictures” on page 92.
2. Press ▲ or ▼ to highlight the file name you wish to copy or move.
3. Press ⏏ [Options] to display the Options menu.
4. Press ▲ or ▼ to highlight the desired option, then press ● or ⏏ [Select] to select.

Options menu varies depending on the selected memory source.

Handset memory: “Copy to Card” or “Move to Card”

Memory card: “Copy to Handset” or “Move to Handset”

## Downloading Picture File (M 6-1-3)

1. Perform steps 1 to 3 in “Viewing Pictures” on page 92.
2. Press ▲ or ▼ to highlight “More Pictures”, then press ● to select.  
The picture file download site is displayed.

## Changing the File Name

1. Perform steps 1 to 4 in “Viewing Pictures” on page 92.
2. Press ▲ or ▼ to highlight the file name you wish to change, then press ⏏ [Options].  
The Options menu is displayed.
3. Press ▲ or ▼ to highlight “Rename”, then press ● or ⏏ [Select] to select.
4. Enter a new file name.  
To correct the last character, press ⏏ [Clear] briefly.  
Press and hold ⏏ [Clear] to clear all characters.
5. Press ●.

### Note

- *Following characters cannot be used for a file name: /, \, ;, \*, ?, ", <, >, | and . (full-stop). (Full-stop can be used for picture files in the memory card.)*

## Adjusting the Size of the Picture

The pictures that are registered in the handset memory or in the memory card can be adjusted for use as main or external displays as well as incoming call, alarm or power on/off displays.

When the picture size is modified, the data size is updated.

1. Perform steps 1 to 4 in “Viewing Pictures” on page 92.
2. Press ▲ or ▼ to highlight the file name you wish to adjust, then press ⏏ [Options].  
The Options menu is displayed.
3. Press ▲ or ▼ to highlight “Adjust Size”, then press ● or ⏏ [Select] to select.
4. Press ▲ or ▼ to highlight “Main Display”, “External Display”, “Power On/Off”, “Incoming” or “Alarm”, then press ● to select.  
The selected picture is displayed.
5. Press ▲, ▼, ◀ or ▶ to specify the area you wish to display, then press ●.
6. Press ● to save.  
To cancel registration, press ⏏ [Back] in step 6.

### Note

- “Adjust Size” may not be available depending on the original picture and copyright issued.

## Sending Messages

1. Perform steps 1 to 4 in “Viewing Pictures” on page 92.
2. Press ▲ or ▼ to highlight the file name you wish to send, then press ⏏ [Options].  
The Options menu is displayed.
3. Press ▲ or ▼ to highlight “Create Message”, then press ● or ⏏ [Select] to select.
4. Enter your message.  
For details on creating a message, see “Creating a New MMS” on page 66.

### Note

- Pictures with a faint icon cannot be sent attached to a message.

### Deleting a Picture

1. Perform steps 1 to 4 in “Viewing Pictures” on page 92.
2. Press ▲ or ▼ to highlight the file name you wish to delete, then press ▢ [Options].  
The Options menu is displayed.
3. Press ▲ or ▼ to highlight “Delete”, then press ● or ▢ [Select] to select.
4. Press ▲ or ▼ to highlight “One Picture”, then press ● to select.
5. Press ▢ [Yes].  
The selected picture is deleted.  
To cancel deletion, Press ▢ [No] in step 5.

#### Tip

- To delete all pictures, press ▲ or ▼ to highlight “All Pictures”, then press ● to select in step 4.

### Checking the Picture Information

1. Perform steps 1 to 4 in “Viewing Pictures” on page 92.
2. Press ▲ or ▼ to highlight the file name you wish to check, then press ▢ [Options].  
The Options menu is displayed.
3. Press ▲ or ▼ to highlight “Picture Details”, then press ● or ▢ [Select] to select.  
The detailed information screen is displayed.
4. Press ▲ or ▼ to scroll through the screen.
5. When you have finished, press ▢ [Back].

## Games & More (M 6-2)

Along with the preloaded application, downloaded applications are stored in Applications.

### *Note*

- *Applications can store up to 50 applications.*

## Using Applications

Various kinds of Vodafone specific applications can be used in this phone.

To use applications, download the applications via the mobile Internet.

Some applications offer the ability to connect to a network either within a game or network based application.

### *Note*

- *Applications may be both localised (no connectivity) and network based (using the mobile Internet to update information/play games). The network may charge you more for using network-based applications. Please contact your service provider for more information.*

## Downloading Applications

### Confirmation Screen













Before downloading the application you are asked to confirm what you are about to receive.

After checking the information on the confirmation screen, the application can be downloaded.



### *Note*

- *User authentication may be required before downloading the application on some information screens.*

### Executing Applications (M 6-2-1)



1. Press  to display the Main menu.
2. Press , ,  or  to highlight “My Stuff”, then press  to select.
3. Press  or  to highlight “Games & More”, then press  to select.
4. Press  or  to highlight “Applications”, then press  to select.

The list of Applications is displayed.  
Downloaded applications are sequentially displayed from the latest one.





5. Press  or  to highlight the title of the application you wish to execute, then press  to select.

The selected application is executed.  
When using network connection type applications, connection to the network can be selected.

### To End the Application









1. Press .
2. Press  or  to highlight “End”, then press  to select.

### To Suspend the Application

1. Press .
2. Press  or  to highlight “Suspend”, then press  to select.









To resume the application, perform steps 1 to 4 in “Executing Applications” and highlight “Resume”, then press .

### Checking the Application Information

1. Perform steps 1 to 4 in “Executing Applications”.
2. Press  or  to highlight the application you wish to check, then press  [Options].  
The Options menu is displayed.
3. Press  or  to highlight “Application Details”, then press  or  [Select] to select.  
The detailed information screen is displayed.
4. Press  or  to scroll through the screen.

5. When you have finished, press  [Back] twice.  
The screen returns to the list.

















### Deleting Applications

1. Perform steps 1 to 4 in “Executing Applications” on page 100.
2. Press  or  to highlight the application you wish to delete, then press  [Options].  
The Options menu is displayed.
3. Press  or  to highlight “Delete”, then press  or  [Select] to select.
4. Press  [Yes].  
The selected application is deleted.  
To cancel deletion, press  [No] in step 4.

#### Note

- *You cannot delete preloaded applications.*

### More Games (M 6-2-2)

1. Press  to display the Main menu.
2. Press , ,  or  to highlight “My Stuff”, then press  to select.
3. Press  or  to highlight “Games & More”, then press  to select.
4. Press  or  to highlight “More Games”, then press  to select.  
The application download site is displayed.
5. Press  or  to highlight the application you wish to download.  
After a WAP browser is displayed variously, the confirmation screen will appear after a whilst.
6. Press  [Get].  
Downloading starts.
7. Press  [OK] even if it carries out complete.

## Sounds (M 6-3)

The ringtones created using the Melody Editor and the AMR data recorded by Voice Recorder are managed in the handset memory or in the memory card. The default ringtones are not contained within the handset memory.



: Sound file in SMAF format



: Original ringtone (composed in Melody Editor)



: Sound file in Standard MIDI format



: Sound file in i Melody format



: Sound file in WAVE format



: Sound file in AMR format



: Sound file in MP3 format

### Tip

- *SMAF (Synthetic music Mobile Application Format) is a format of music data for mobile phones.*
- *The MP3 sound file is played back by the MP3 Player application.*

## Downloading Sound Files (M 6-3-3)

1. Press to display the Main menu.
2. Press , , or to highlight “My Stuff”, then press to select.
3. Press or to highlight “Sounds”, then press to select.

4. Press or to highlight “More Sounds”, then press to select.

The sound file download site is displayed.

## Playing Back Sounds

1. Press to display the Main menu.
2. Press , , or to highlight “My Stuff”, then press to select.
3. Press or to highlight “Sounds”, then press to select.
4. Press or to highlight “Handset Memory” or “Memory Card”, then press to select.  
The list of sounds is displayed.
5. Press or to highlight the sound you wish to play back, then press to select.  
The selected sound is played.  
To stop playing, press .

### Tip

- *The memory source indicator (handset: or memory card: ) is displayed so that you can find the memory you are using.*

### Using the Sounds as Ringtone

You can use this option only for sounds saved in the handset memory.

1. Perform steps 1 to 4 in “Playing Back Sounds” on page 102.
2. Press ▲ or ▼ to highlight the file name you wish to use as ringtone, then press ⏏ [Options].  
The Options menu is displayed.
3. Press ▲ or ▼ to highlight “Set as Ringtone”, then press ● or ⏏ [Select] to select.  
The selected sound is automatically used for the ringtone of the current Profiles.

#### Note

- Files in AMR/WAVE and MP3 format cannot be used for the ringtone.

### Copying or Moving Sound Files

You can copy or move sound files between the handset memory and memory card.

1. Perform steps 1 to 4 in “Playing Back Sounds” on page 102.
2. Press ▲ or ▼ to highlight the file name you wish to copy or move.

3. Press ⏏ [Options] to display the Options menu.
4. Press ▲ or ▼ to highlight the desired option, then press ● or ⏏ [Select] to select.  
Options menu varies depending on the selected memory source.  
Handset memory: “Copy to Card” or “Move to Card”  
Memory card: “Copy to Handset” or “Move to Handset”

### Checking the Information of the Sound Files

1. Perform steps 1 to 4 in “Playing Back Sounds” on page 102.
2. Press ▲ or ▼ to highlight the file name you wish to check, then press ⏏ [Options].  
The Options menu is displayed.
3. Press ▲ or ▼ to highlight “Sound Details”, then press ● or ⏏ [Select] to select.  
The detailed information screen is displayed.
4. Press ▲ or ▼ to scroll through the screen.
5. When you have finished, press ⏏ [Back].  
The screen returns to the list.



## Changing the File Name

1. Perform steps 1 to 4 in “Playing Back Sounds” on page 102.
2. Press ▲ or ▼ to highlight the file name you wish to change, then press ⏏ [Options].  
The Options menu is displayed.
3. Press ▲ or ▼ to highlight “Rename”, then press ● or ⏏ [Select] to select.
4. Enter a new file name.  
To delete the last character, press ⏏ [Clear] briefly. Press and hold ⏏ [Clear] to clear all characters.
5. Press ●.

### Note

- Following characters cannot be used for a file name: /, \, ;, \*, ?, ", <, >, | and . (full-stop). (Full-stop can be used for sound files in the memory card.)

### Tip

- When “Edit Data” is displayed in the menu in step 2, you are able to edit the sound (p. 134). Once you have completed editing the newly saved file overwrites the old file. This new file then becomes the original ringtone.

## Setting the Tone and Strength

1. Perform steps 1 to 4 in “Playing Back Sounds” on page 102.
2. Press ▲ or ▼ to highlight the file name you wish to edit, then press ⏏ [Options].  
The Options menu is displayed.
3. Press ▲ or ▼ to highlight “Set Tone” or “Set Strength”, then press ● or ⏏ [Select] to select.  
For full details, see pages 131 to 134.

### Note

- If “Set Tone” and “Set Strength” are not displayed in the menu in step 2, you cannot change these settings.

## Sending Messages

1. Perform steps 1 to 4 in “Playing Back Sounds” on page 102.
2. Press ▲ or ▼ to highlight the file name you wish to send, then press ⏏ [Options].  
The Options menu is displayed.
3. Press ▲ or ▼ to highlight “Create Message”, then press ● or ⏏ [Select] to select.

If you select your original ringtone in step 2, perform the following, otherwise go to step 5.

4. Press ▲ or ▼ to highlight the file format “SMAF”, “MIDI” or “i Melody”, then press ● to select.
5. Enter your message.  
For details on creating a message, see “Creating a New MMS” on page 66.

**Note**

- MP3 sound files cannot be sent attached to a message.
- Sounds with a faint icon cannot be sent attached to a message.
- Only the first part of the data is converted if you select “i Melody” in step 4.

**Deleting a Sound**

1. Perform steps 1 to 4 in “Playing Back Sounds” on page 102.
2. Press ▲ or ▼ to highlight the file name you wish to delete, then press ⏏ [Options].  
The Options menu is displayed.
3. Press ▲ or ▼ to highlight “Delete”, then press ● or ⏏ [Select] to select.
4. Press ▲ or ▼ to highlight “One Sound”, then press ● to select.

5. Press ⏏ [Yes].  
The selected sound file is deleted.  
To cancel deletion, press ⏏ [No] in step 5.

**Tip**

- To delete all sounds, press ▲ or ▼ to highlight “All Sounds”, then press ● to select in step 4.





















**Videos (M 6-4)**

Video clips that are recorded by a video camera or video clips that are downloaded from mobile Internet sites can be managed.



**Downloading Video Clip Files (M 6-4-3)**

1. Press ● to display the Main menu.
2. Press ▲, ▼, ⏏ or ▶ to highlight “My Stuff”, then press ● to select.
3. Press ▲ or ▼ to highlight “Videos”, then press ● to select.
4. Press ▲ or ▼ to highlight “More Videos”, then press ● to select.  
The video clip file download site is displayed.

## Playing Back Video Clip Files







1. Press  to display the Main menu.
2. Press , ,  or  to highlight “My Stuff”, then press  to select.
3. Press  or  to highlight “Videos”, then press  to select.
4. Press  or  to highlight “Handset Memory” or “Memory Card”, then press  to select.  
The list of video clips is displayed.
5. Press  or  to highlight the video clip you wish to play back, then press  to select.
6. Press .  
The selected video clip is played back.  
To pause playback, press .  
To resume playback, press  again.  
To stop playback, press  [Back].  
To return to the original size, press  [×1].

### Tip







- The memory source indicator (handset:  or memory card: ) is displayed so that you can find the memory you are using.

## Copying or Moving Video Clips

You can copy or move video clips between the handset memory and memory card.

1. Perform steps 1 to 4 in “Playing Back Video Clip Files”.
2. Press  or  to highlight the file name you wish to copy or move.
3. Press  [Options] to display the Options menu.
4. Press  or  to highlight the desired option, then press  or  [Select] to select.  
Options menu varies depending on the selected memory source.  
Handset memory: “Copy to Card” or “Move to Card”  
Memory card: “Copy to Handset” or “Move to Handset”

## Checking the Video Clip File Information

1. Perform steps 1 to 4 in “Playing Back Video Clip Files”.
2. Press  or  to highlight the file name you wish to check, then press  [Options].  
The Options menu is displayed.
3. Press  or  to highlight “Video Details”, then press  or  [Select] to select.  
The detailed information screen is displayed.

4. Press ▲ or ▼ to scroll through the screen.
5. When you have finished, press ⏪ [Back].

### Changing the File Name

1. Perform steps 1 to 4 in “Playing Back Video Clip Files” on page 106.
2. Press ▲ or ▼ to highlight the file name you wish to change, then press ⏪ [Options].  
The Options menu is displayed.
3. Press ▲ or ▼ to highlight “Rename”, then press ● or ⏪ [Select] to select.
4. Enter a new file name.  
To delete the last character, press ⏩ [Clear] briefly.  
Press and hold ⏩ [Clear] to clear all characters.
5. Press ●.

#### Note

- *Following characters cannot be used for a file name: /, \, :, \*, ?, ", <, >, | and . (full-stop). (Full-stop can be used for video clips in the memory card.)*

### Sending Messages

1. Perform steps 1 to 4 in “Playing Back Video Clip Files” on page 106.
2. Press ▲ or ▼ to highlight the file you wish to send, then press ⏪ [Options].  
The Options menu is displayed.
3. Press ▲ or ▼ to highlight “Create Message”, then press ● or ⏪ [Select] to select.
4. Enter your message.  
For details on creating a message, see “Creating a New MMS” on page 66.

#### Note

- *Video Clips with a faint icon cannot be sent attached to a message.*

### Deleting a Video Clip File

1. Perform steps 1 to 4 in “Playing Back Video Clip Files” on page 106.
2. Press ▲ or ▼ to highlight the file name you wish to delete, then press ⏏ [Options].  
The Options menu is displayed.
3. Press ▲ or ▼ to highlight “Delete”, then press ● or ⏏ [Select] to select.
4. Press ▲ or ▼ to highlight “One Video”, then press ● to select.
5. Press ⏏ [Yes].  
The selected video clip file is deleted.  
To cancel deletion, press ⏏ [No] in step 5.

#### Tip

- To delete all video clip files, press ▲ or ▼ to highlight “All Videos”, then press ● to select in step 4.

### Bookmarks (M 6-5)

You can store desired (or frequently used) pages (addresses) in Bookmarks. It can save your time in accessing WAP pages sites. For further details, see “Vodafone live!” on page 87.









## Text Templates (M 6-6)

You can register up to 20 text templates for use in text messages and multimedia messages.





You can input messages more easily by registering frequently used text.

120 characters may be registered in any text template.

### Adding Phrases to Text Templates







1. Press  to display the Main menu.
2. Press , ,  or  to highlight “My Stuff”, then press  to select.
3. Press  or  to highlight “Text Templates”, then press  to select.

The list of Text Templates is displayed.









4. Press  or  to highlight the number you wish to register, then press  to select.
5. Enter the text, then press .

For details on entering characters, see “Entering Characters” on page 32.

### Editing Text Templates

1. Perform steps 1 to 3 in “Adding Phrases to Text Templates”.
2. Press  or  to highlight the number you wish to edit, then press .
3. Enter new text.  
To correct the last character, press  [Clear] briefly.  
Press and hold  [Clear] to clear all characters.
4. Press .

### Viewing Text Templates

1. Perform steps 1 to 3 in “Adding Phrases to Text Templates”.
2. Press  or  to highlight the number you wish to view, then press  [Options].  
The Options menu is displayed.
3. Press  or  to highlight “View”, then press  or  [Select] to select.  
The selected text template is displayed.
4. After confirmation, press  [Back] to return to the template list.

## Deleting Text Templates

1. Perform steps 1 to 3 in “Adding Phrases to Text Templates” on page 109.
2. Press ▲ or ▼ to highlight the text template you wish to delete, then press ⏏ [Options].
3. Press ▲ or ▼ to highlight “Delete”, then press ● or ⏏ [Select] to select.
4. Press ⏏ [Yes].  
The selected text template is deleted.  
To cancel deletion, press ⏏ [No] in step 4.

4. Press ▲ or ▼ to highlight “Handset Memory” or “Memory Card”, then press ● to select.

## Memory Status (M 6-7)

This function helps you to check the memory status of the handset memory or memory card. Memory status covers the followings.

Handset Memory: Applications, Pictures, Sounds, and Videos







Memory Card: Pictures, Sounds, Videos and Others

1. Press ● to display the Main menu.
2. Press ▲, ▼, ◀ or ▶ to highlight “My Stuff”, then press ● to select.
3. Press ▲ or ▼ to highlight “Memory Status”, then press ● to select.

## **Games & More (M 1)**













### **Executing Applications (M 1-1)**







You can execute games and other applications on your phone. For details about Applications, see page 100.

1. Press  to display the Main menu.
2. Press , ,  or  to highlight “Games & More”, then press  to select.
3. Perform steps 4 and 5 in “Executing Applications” on page 100.

### **Screensavers (M 1-2)**

You can download screensaver applications for the stand-by screen.

1. Press  to display the Main menu.
2. Press , ,  or  to highlight “Games & More”, then press  to select.
3. Press  or  to highlight “Screensavers”, then press  to select.
4. Press  or  to highlight “On/Off”, then press  to select.







5. Press  or  to highlight “On” to set screensavers on or “Off” to set screensavers off, then press  to select.
6. If you select “On”, press  or  to highlight the desired application, then press  to select.

#### **Note**

- *In the list that appears in step 6, only the available screensavers can be selected.*

### **Online Setting (M 1-2-2)**

You can set whether to connect to the network or not using the screensaver application.

1. Perform steps 1 to 3 in “Screensavers”.
2. Press  or  to highlight “Online Setting”, then press  to select.
3. Press  or  to highlight “On” or “Off”, then press  to select.



### Note

- Changes made to the above setting whilst the application is suspended are made effective by restarting the application.
- You may not be able to make the above settings depending on your network.

### Resume Time (M 1-2-3)

You can set the time period for the screensaver application to activate.

1. Perform steps 1 to 3 in “Screensavers” on page 111.
2. Press ▲ or ▼ to highlight “Resume Time”, then press ● to select.
3. Enter the resume time in two digits using the digit keys, then press ●.

### More Games (M 1-3)

You can download applications.

1. Press ● to display the Main menu.
2. Press ▲, ▼, ◀ or ▶ to highlight “Games & More”, then press ● to select.
3. Press ▲ or ▼ to highlight “More Games”, then press ● to select.  
The application download site is displayed.
4. Perform steps 5 to 7 in “More Games” on page 101.

## Settings (M 1-4)

### Opening the Settings Screen

1. Press ● to display the Main menu.
2. Press ▲, ▼, ◀ or ▶ to highlight “Games & More”, then press ● to select.
3. Press ▲ or ▼ to highlight “Settings”, then press ● to select.

The Settings screen is displayed. The following settings can be made.

### Operation Priority (M 1-4-1)

You can set the priority of incoming calls and alarms whilst an application is operating.

1. Perform steps 1 to 3 in “Opening the Settings Screen”.
2. Press ▲ or ▼ to highlight “Calls & Alarms”, then press ● to select.
3. Press ▲ or ▼ to highlight the option you wish to set, then press ● to select.

The options available are:

- “Incoming Call”
- “Alarm”

4. Press ▲ or ▼ to highlight methods, then press ● to select.
  - “Call Priority” or “Alarm Priority”:  
The application is suspended automatically, and you can receive a call, or the alarm will sound. After finishing the call or the alarm ends, the suspend icon (⏸) is displayed letting know there is a suspended application.
  - “Call Notice” or “Alarm Notice”:  
The marquee (character scrolls) is displayed on the first line of the screen whilst the application continues. If you press ↵, the application is suspended, and you can receive a call. After finishing the call, the suspend icon (⏸) is displayed letting know there is a suspended application.

### **Sound Volume (M 1-4-2)**

You can set the volume of the application such as sound effect to one of the five levels or silent. When “Ringer Volume” (p. 139) is set to “Silent”, this setup has priority.

1. Perform steps 1 to 3 in “Opening the Settings Screen” on page 112.
2. Press ▲ or ▼ to highlight “Sound Volume”, then press ● to select.  
The current volume level is displayed.
3. Press ▲ to increase the volume or press ▼ to decrease the volume, then press ● to select.

### **Backlight (M 1-4-3)**

You can select the backlight method of the application from the following three types:

- “On”: Lit whilst the application is operated.
  - “Off”: Unlit whilst the application is operated even if a key is pressed.
  - “Normal Settings”: Works with the main backlight setting. (p. 156)
1. Perform steps 1 to 3 in “Opening the Settings Screen” on page 112.

2. Press ▲ or ▼ to highlight “Backlight”, then press ● to select.
3. Press ▲ or ▼ to highlight “On/Off”, then press ● to select.
4. Press ▲ or ▼ to highlight “On”, “Off” or “Normal Settings”, then press ● to select.

#### To Set the Blinking Operation

This setting enables the backlight to be controlled by the application. If set to “Off”, the backlight cannot be turned on from the application.

1. Perform steps 1 to 3 in “Opening the Settings Screen” on page 112.
2. Press ▲ or ▼ to highlight “Backlight”, then press ● to select.
3. Press ▲ or ▼ to highlight “Blink”, then press ● to select.
4. Press ▲ or ▼ to highlight “On” or “Off”, then press ● to select.

#### Vibration (M 1-4-4)

When the vibrator is set in the application, you can choose whether the operation is enabled or disabled.

When a SMAF file is specified in the application, you can operate the vibrator set in the SMAF file.

#### Note

- *SMAF (Synthetic music Mobile Application Format) is a music data format for mobile phones.*

1. Perform steps 1 to 3 in “Opening the Settings Screen” on page 112.
2. Press ▲ or ▼ to highlight “Vibration”, then press ● to select.
3. Press ▲ or ▼ to highlight “Enable”, “Disable” or “Link to Sound”, then press ● to select.

When you set “Link to Sound”, the sound of SMAF file in the application is synchronised with the vibrator.

### Online Confirmation (M 1-4-5)

You can select the display settings of the confirmation screen of the application on application startup.

1. Perform steps 1 to 3 in “Opening the Settings Screen” on page 112.
2. Press ▲ or ▼ to highlight “Online Confirmation”, then press ● to select.
3. Press ▲ or ▼ to highlight “On”, then press ● to select.  
To cancel confirmation, highlight “Off”, then press ● to select.

### Reset (M 1-4-6)

To Reset All Items in Settings Menu

1. Perform steps 1 to 3 in “Opening the Settings Screen” on page 112.
2. Press ▲ or ▼ to highlight “Reset”, then press ● to select.
3. Enter your handset code, then press ●.  
The default handset code is “0000”. For details on changing the handset code, see “To Change Handset Code” on page 185.  
If you enter a wrong handset code, the screen will return to step 3 in “Opening the Settings Screen” on page 112.
4. Press ▲ or ▼ to highlight “Settings Reset”, then press ● to select.
5. Press ⏏ [Yes].  
All items in Settings menu and screensaver settings are reset.  
To cancel resetting, press ⏏ [No] in step 5.

### To Clear All Applications

All applications stored in Applications are cleared. The preloaded application cannot be deleted.

1. Perform steps 1 to 3 in “Opening the Settings Screen” on page 112.
2. Press ▲ or ▼ to highlight “Reset”, then press ● to select.
3. Enter your handset code, then press ●.  
If you enter a wrong handset code, the screen will return to step 3 in “Opening the Settings Screen” on page 112.
4. Press ▲ or ▼ to highlight “All Clear”, then press ● to select.
5. Press ⏏ [Yes].  
All applications are cleared.  
To cancel clearing, press ⏏ [No] in step 5.

### Java™ Information (M 1-5)

The information about the license belonging to Java™ can be displayed.

## **Applications (M 3)**













### **SIM Application (M 3-1)**





















You can refer to the information on the SIM. Contact your service provider for further details.





### **MP3 Player (M 3-2)**

The MP3 Player allows you to play back MP3 sound files at the recommended bit rate of 128 Kbps. MP3 sound file of VBR (Variable Bit Rate) is not supported. Store MP3 sound files in the SOUND folder when using the memory card.

#### **Playing Back MP3 Files**

1. Press  to display the Main menu.
2. Press , ,  or  to highlight “Applications”, then press  to select.
3. Press  or  to highlight “MP3 Player”, then press  to select.
4. Press  or  to highlight the desired memory, then press  to select.  
MP3 sound files from the selected memory are listed.

5. Press  or  to highlight the desired MP3 sound file, then press  to start playback.
  - To pause, press .
  - To repeat playback, press  [Options] and press  or  to highlight “Repeat On”, then press  or  [Select] to select. To turn the repeat setting off, select “Repeat Off”, then press  to select. Pressing  also allows you to turn on or off this setting.
  - To adjust the volume, press  or , or the side-up or side-down key.
  - To skip to the head of the current file, press , and to skip to the previous file, press  in succession.
  - To skip to the next file, press .
  - To display the detailed information of the MP3 sound file (Title, Artist, Play Time, Bit Rate, Sampling Rate), press  [Options] and press  or  to highlight “Music Details”, then press  or  [Select] to select.









- To change the MP3 sound file or change the order in the play list, press  [Options] and press  or  to highlight “My Sounds”, then press  or  [Select] to select.

**Tip**

- MP3 sound files can also be played back by selecting “Sounds” from the “My Stuff” menu.
- The starting volume of the MP3 Player is 0 when the “Ringer Volume” (p. 139) is set to “Silent”.









**To Sort MP3 Sound Files**

You can sort MP3 sound files in the memory card by file name, date, or at random.









1. Perform steps 1 to 4 in “Playing Back MP3 Files” on page 117.
2. Press  [Options] to display the Options menu.
3. Press  or  to highlight “Sort Type”, then press  or  [Select] to select.
4. Press  or  to highlight the desired sort type, then press  to select.

**Calendar (M 3-3)**



The Calendar function helps you organise and manage your busy schedule. You can view the stored schedule on a monthly basis.

1. Press  to display the Main menu.
2. Press , ,  or  to highlight “Applications”, then press  to select.
3. Press  or  to highlight “Calendar”, then press  to select.

The current month is displayed and the current date is highlighted.

4. Press , ,  or  to highlight the day for the schedule, then press  to select.
5. Press  or  to highlight the desired note frame, then press  to select.

Up to 3 schedule items can be stored.







6. Enter the schedule content, then press .  
For details on entering characters, see “Entering Characters” on page 32.  
If you wish to add another item, repeat steps 5 and 6.
7. When you have finished entering, press  [Back].  
The screen returns to the calendar. Dates with scheduled tasks/meetings are underlined.

**Note**

- *The calendar can be displayed for dates from January 2000 through to December 2099.*









**To Find a Particular Date**

You can move the view to a specified date in the calendar.

1. Perform steps 1 to 3 in “Calendar” on page 118.  
The current month is displayed and the current date is highlighted.
2. Press  [Options] to display the Options menu.
3. Press  or  to highlight “Go to Date”, then press  or  [Select] to select.
4. Enter the date of the calendar to be displayed, then press .  
The specified date is displayed.

**To Change to Weekly Format**

You can change the Calendar to weekly format.

1. Perform steps 1 to 3 in “Calendar” on page 118.  
The current month is displayed and the current date is highlighted.
2. Press  [Options] to display the Options menu.
3. Press  or  to highlight “Weekly Format”, then press  or  [Select] to select.
4. Press  or  to highlight “Monday-Sunday” to display weekly format from Monday or “Sunday-Saturday” to display weekly format from Sunday, then press  to select.



## Deleting Schedules

### To Delete Schedule Items

1. Perform steps 1 to 3 in “Calendar” on page 118.
2. Press ▲, ▼, ◀ or ▶ to highlight the day, then press ● to select.
3. Press ▲ or ▼ to highlight the item you wish to delete, then press ▢ [Options].  
The Options menu is displayed.
4. Press ▲ or ▼ to highlight “Delete”, then press ● or ▢ [Select] to select.
5. Press ▲ or ▼ to highlight “1 data”, then press ● to select.
6. Press ▢ [Yes].  
To cancel deletion, press ▢ [No] in step 6.

### To Delete All Scheduled Tasks/Meetings for a Specific Day

1. Perform steps 1 to 3 in “Calendar” on page 118.
2. Press ▲, ▼, ◀ or ▶ to highlight the day you wish to delete, then press ▢ [Options].  
The Options menu is displayed.
3. Press ▲ or ▼ to highlight “Delete”, then press ● or ▢ [Select] to select.

4. Press ▲ or ▼ to highlight “1 day” to delete all contents for a day, then press ● to select.
5. Press ▢ [Yes].  
To cancel deletion, press ▢ [No] in step 5.

### To Delete All Scheduled Entries

1. Perform steps 1 to 3 in “Calendar” on page 118.
2. Press ▢ [Options] to display the Options menu.
3. Press ▲ or ▼ to highlight “Delete” to delete all scheduled entries, then press ● or ▢ [Select] to select.
4. Press ▲ or ▼ to highlight “All Data” to delete all scheduled entries, then press ● to select.
5. Press ▢ [Yes].  
To cancel deletion, press ▢ [No] in step 5.















## Alarms (M 3-4)

### Setting the Alarms (M 3-4-1)

The alarm function allows you to be alerted daily or at a specified date and time.

Note that the alarm may not function correctly if the clock has not been set.

The alarm functions only if the phone is switched on.













1. Press  to display the Main menu.
  2. Press , ,  or  to highlight “Applications”, then press  to select.
  3. Press  or  to highlight “Alarms”, then press  to select.
  4. Press  or  to highlight “List Alarms”, then press  to select.
  5. Press  or  to highlight the desired alarm number, then press  to select.
- Up to 8 alarms can be specified.

### When you wish to set the daily alarm





6. Press  or  to highlight “Daily Alarm”, then press  to select.

7. Enter the alarm time using the digit keys, then press .



When you enter the alarm time in the 12-hour clock format, press  to switch between am and pm.

8. Press  or  to highlight “Repeat Daily”, then press  to select.
9. Press  or  to highlight “On” or “Off”, then press  to select.
10. Press  or  to highlight “Alarm Status”, then press  to select.
11. Press  or  to highlight “On”, then press  to select.
12. Press  [Save].

### When you wish to specify the date and time

6. Press  or  to highlight “Specific Date”, then press  to select.
7. Enter the alarm date and time using the digit keys, then press .

When you enter the alarm time in the 12-hour clock format, press  to switch between am and pm.

8. Press  or  to highlight “Alarm Status”, then press  to select.

9. Press ▲ or ▼ to highlight “On”, then press ● to select.

10. Press ▢ [Save].

### To Change the Type of Alarm Tone

1. Perform steps 1 to 5 in “Setting the Alarms” on page 121.

2. Press ▲ or ▼ to highlight “Alarm Tone”, then press ● to select.

3. Press ▲ or ▼ to highlight “Tone”, then press ● to select.

4. Press ▲ or ▼ to highlight “Preset Sounds” or “My Sounds”, then press ● to select.

5. Press ▲ or ▼ to highlight the alarm tone.  
If you wish to hear the demo play, press ●.  
To stop playing, press ●.

6. When selection is complete, press ▢ [Options] to display the Options menu.

7. Press ▲ or ▼ to highlight “Assign”, then press ● or ▢ [Select] to select.

### To Change the Vibration of the Alarm

1. Perform steps 1 to 5 in “Setting the Alarms” on page 121.

2. Press ▲ or ▼ to highlight “Alarm Tone”, then press ● to select.

3. Press ▲ or ▼ to highlight “Vibration”, then press ● to select.

4. Press ▲ or ▼ to highlight “Enable”, “Disable” or “Link to Sound”, then press ● to select.

### To Change the Duration of the Alarm

1. Perform steps 1 to 5 in “Setting the Alarms” on page 121.

2. Press ▲ or ▼ to highlight “Alarm Tone”, then press ● to select.

3. Press ▲ or ▼ to highlight “Duration”, then press ● to select.

The current duration is displayed.

4. Enter the length of the duration in 2 digits (02 to 59 seconds) using the digit keys, then press ●.

### Changing Alarm Settings

1. Perform steps 1 to 4 in “Setting the Alarms” on page 121.
2. Press ▲ or ▼ to highlight the number you wish to change, then press ● to select.
3. Change alarm settings.  
For details on changing alarm settings, see “Setting the Alarms” on page 121.

### Disabling the Alarm Function

1. Perform steps 1 to 5 in “Setting the Alarms” on page 121.
2. Press ▲ or ▼ to highlight “Alarm Status”, then press ● to select.
3. Press ▲ or ▼ to highlight “Off”, then press ● to select.
4. Press ⏏ [Save].

### Resetting an Alarm Setting













1. Perform steps 1 to 3 in “Setting the Alarms” on page 121.
2. Press ▲ or ▼ to highlight the number you wish to reset, then press ● to select.
3. Press ▲ or ▼ to highlight “Reset Alarm”, then press ● to select.
4. Press ⏏ [Yes].  
To cancel resetting, press ⏏ [No] in step 4.

### Resetting All Alarm Settings (M 3-4-2)

1. Perform steps 1 to 3 in “Setting the Alarms” on page 121.
2. Press ▲ or ▼ to highlight “Clear All”, then press ● to select.
3. Press ⏏ [Yes].  
To cancel resetting, press ⏏ [No] in step 3.

## Calculator (M 3-5)

The calculator function performs the 4 arithmetic calculations using up to 12 digits.

1. Press  to display the Main menu.
2. Press , ,  or  to highlight “Applications”, then press  to select.
3. Press  or  to highlight “Calculator”, then press  to select.
4. Press  or  to highlight “Calculator”, then press  to select.

The calculator is displayed on the display.

5. Key operations for calculation are as follows.



To enter a decimal point, press .

To clear the entered number or operand, press  [Clear].









To do the calculations, press .

6. If you wish to start a new calculation, press  [Clear].





## Rate Conversion (M 3-5-2)

You can also use the calculator as a currency calculator to convert from/to a home currency using a conversion rate that you enter.

To Set a Currency Conversion Rate

1. Perform steps 1 to 3 in “Calculator”.
2. Press  or  to highlight “Exchange Rate”, then press  to select.
3. Press  or  to highlight “Foreign → Domestic” or “Domestic → Foreign”, then press  to select.
4. Enter the currency conversion rate, then press . To delete all digits, press  [Clear].

### To Convert a Value

1. Perform steps 1 to 4 in “Calculator” on page 124.
2. Enter the value to be converted, then press  [Options].  
The Options menu is displayed.
3. Press  or  to highlight “In Domestic” or “In Foreign”, then press  or  [Select] to select.  
The result is displayed.  
If you select “Exchange Rate” in step 3, you can set a currency conversion rate.

#### **Note**









- You cannot perform step 2 when an arithmetic symbol (+, -, × or ÷) is displayed.

### Voice Recorder (M 3-6)







This allows you to record a voice clip of up to 60 seconds, which can be used to remind you of schedule entries or be sent within a multimedia message. The recorded voice clip is registered in the handset memory or in the memory card. Voice clips are saved in “.amr” format.

#### **Selecting the Memory**

When using the memory card, you can choose the memory before recording voice clips.

1. In Voice Recorder mode, press  [Options].  
The Options menu is displayed.
2. Press  or  to highlight “Save New Sounds to”, then press  or  [Select] to select.
3. Press  or  to highlight “Handset Memory”, “Memory Card” or “Choice”, then press  to select.

#### **Recording a Voice Clip**

1. Press  to display the Main menu.
2. Press , ,  or  to highlight “Applications”, then press  to select.

3. Press ▲ or ▼ to highlight “Voice Recorder”, then press ● to select.
4. Press ● to start recording.  
To stop recording before the recording time is over, press ●.
5. Press ▲ or ▼ to highlight “Save” to save the voice clip, then press ● to select.  
If you have selected “Choice” when saving, the memory card is not inserted, or memory has run out, press ▲ or ▼ to highlight “Save to Handset” or “Save to Card”, then press ●.

**Tip**

- You can also record a voice clip by pressing ● during stand-by, then press # whilst the Main menu is displayed, instead of steps 1 to 3.
- If you wish to record a voice clip again, press [Cancel] in step 5. The screen will return to step 4.

**Selecting the Recording Time Mode**

You can select the recording time mode.

1. Perform steps 1 to 3 in “Recording a Voice Clip” on page 125.
2. Press [Options] to display the Options menu.
3. Press ▲ or ▼ to highlight “Record Time”, then press ● or [Select] to select.
4. Press ▲ or ▼ to highlight “Extended Voice” or “For Message Sending”, then press ● to select.

**Playing Back the Recorded Voice Clip**

1. Perform steps 1 to 4 in “Recording a Voice Clip” on page 125.
2. Press ▲ or ▼ to highlight “Playback”, then press ● to select.
3. Press ●.  
The recorded voice clip is played back.  
To stop playback, press ●.

### Tip

- The volume varies depending on the Ringer Volume settings (p. 139). To adjust the volume, press ▲ or ▼, or the side-up or side-down key. The volume is 0 when “Ringer Volume” is set to “Silent” and 1 when set to “Step Tone”.

### Sending Voice Clips

1. Perform steps 1 to 4 in “Recording a Voice Clip” on page 125.
2. Press ● to stop recording.
3. Press ▲ or ▼ to highlight “Save and Send”, then press ● to select.
4. Perform steps 4 to 6 in “Creating a New MMS” on page 66.

### Note

- “Save and Send” is not displayed after recording in extended voice mode.

## Melody Editor (M 3-7)

You can create an original ringtone, or you can send a melody attached to a multimedia message.

You can input up to 95 tones × 32 voices, 190 tones × 16 voices, or 380 tones × 8 voices per melody.

The original ringtone is registered in the handset memory.

### Creating Your Original Ringtone (M 3-7-1)

1. Press ● to display the Main menu.
2. Press ▲, ▼, ◀ or ▶ to highlight “Applications”, then press ● to select.
3. Press ▲ or ▼ to highlight “Melody Editor”, then press ● to select.
4. Press ▲ or ▼ to highlight “Create New”, then press ● to select.
5. Enter the title.  
Up to 24 characters can be entered.  
For details on entering characters, see “Entering Characters” on page 32.
6. Press ●.



7. Press ▲ or ▼ to highlight a tempo, then press ● to select.

The music tempo is described below.

- “Allegro (Fast)”: ♪ 150
- “Moderato (Normal)”: ♪ 125
- “Andante (Slow)”: ♪ 107
- “Adagio (Very Slow)”: ♪ 94

Tempo is defined by the number of crotchets ( ♪ ) played per minute.

8. Press ▲ or ▼ to highlight “8 Chords”, “16 Chords” or “32 Chords”, then press ● to select.

9. Press the digit keys to specify the musical scale and rest.

For details on specifying the sound level and rest, see “To Specify the Musical Scale and Rest” on page 129.

10. Press \*+o or # to specify the types of musical notes or rest.

For details on specifying the musical notes and rest, “To Specify the Types of Notes and Rests” on page 130.

11. Press ▶ after inputting one note.

Input the next note after the cursor moves to the right.

12. Repeat steps 9 to 11 to input notes.

When you press ● during input, the melody that you have entered is played back.

When you press ▢ [Options] and select “Play before Cursor” whilst entering notes, the melody, that is displayed on the screen, is played back up to the cursor position.

When you press ▢ [Options] and select “Select Part”, you can select another chord. Repeat steps 9 to 11 to input notes for the new chord.

13. When you finish inputting, press ▢ [Options] to display the Options menu.

14. Press ▲ or ▼ to highlight “Save”, then press ● or ▢ [Select] to select.

15. Press ▲ or ▼ to highlight “Save to My Stuff”, then press ● to select.

Your original ringtone is registered in the handset memory.

**Note**

- If the capacity or memory in the handset memory becomes insufficient, the message, "Maximum capacity : 1000 Not registered." or "Not registered. Memory full." is displayed. The display returns to the screen of step 15. Try again after deleting unnecessary data (p. 105).
- Melodies consisting of too many short notes (semiquavers and triplets) cannot be played back in step 12 and the following message is displayed: "Can not play due to too many notes per sec." The screen returns to step 9. The message "Can not save due to too many notes per sec." may also be displayed, and the screen returns to step 9. Reduce the number of melodies, replace short notes, cancel triplets, etc. to remedy.

**To Specify the Musical Scale and Rest**

Using the keys shown below, specify the musical scale and rest.

Do	Re	Mi	Fa	Sol	La	Ti	Rest
1 <small>ad</small>	2 <small>ABC</small>	3 <small>DEF</small>	4 <small>GHI</small>	5 <small>JKL</small>	6 <small>MNO</small>	7 <small>PQRS</small>	0 <small>...</small>

When you press the key shown above once, a crotchet is specified in the middle scale (no mark).

When you press the same key repeatedly, the note will shift cycle through the available octave ranges.



When you press or whilst a note is selected, the note will move one semitone higher or lower.

When entering rest: Crotchet rest is entered.

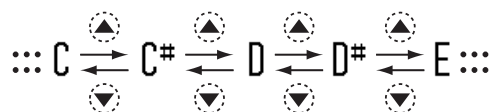

To Specify the Types of Notes and Rests  
Specify notes and rests by pressing **[\*+0]** or **[#]** repeatedly.

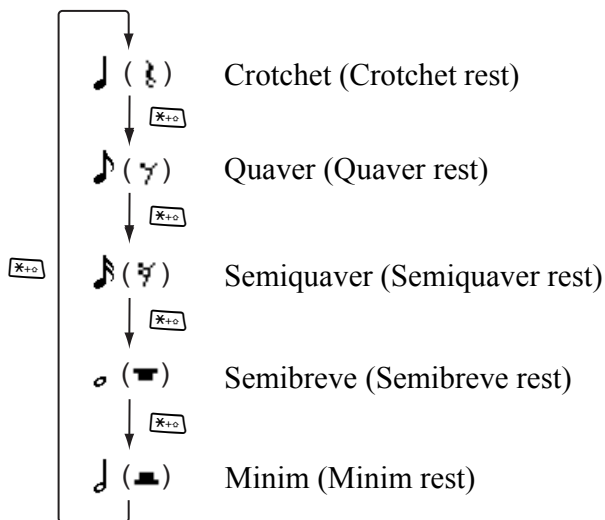

When you make a dotted note or a triplet, press **[9m12]** after selecting the target note.

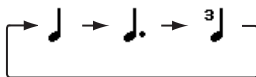

**Note**

- You cannot make a dotted semiquaver (semiquaver rest) or a dotted semibreve (semibreve rest).
- Three continuous notes are required for a triplet.

To specify a tie, press **[8m12]** after selecting the target notes.

An underscore (   ) is displayed next to the note, and the note is tied with the next one.

To enter the next note, press **[▶]** and move the cursor to the right. Then, repeat the operation on the previous page.

If the cursor is positioned next to a note, you can repeat the note immediately left of the cursor when **[▲]** or **[▼]** is pressed.

## To Set the Tone

The phone can play notes using different instruments.

1. Perform steps 1 to 13 in “Creating Your Original Ringtone” on page 127.
2. Press ▲ or ▼ to highlight “Set Tone”, then press ● to select.
3. Press ◀ or ▶ to highlight a category of the tone.
4. Press ▲ or ▼ to highlight a tone.

When you press ⏏ [Options] and select “Play Current Part”, the melody entered is played back in the selected tone.

When you press ⏏ [Options] and select “Confirm Tones”, the syllable names are played back in the selected tone.

5. Press ●.

Now you can create a melody.

You can select from the following 128 basic tones and 61 extended tones.

### Basic tones

Category	Tone	Category	Tone
Pianos	Piano	Chimes	Celesta
	Bright Piano		Glockenspiel
	E. Grand Piano		Music Box
	Honky-tonk		Vibraphone
	Electric Piano 1		Marimba
	Electric Piano 2		Xylophone
	Harpichord		Tubular Bells
	Clavi		Dulcimer
Organs	Drawbar Organ	Guitars	Nylon Guitar
	Percussive Organ		Steel Guitar
	Rock Organ		Jazz Guitar
	Church Organ		Clean Guitar
	Reed Organ		Muted Guitar
	Accordion		Overdriven Guitar
	Harmonica		Distortion Guitar
	Tango Accordion		Guitar Harmonics
Basses	Acoustic Bass	Strings 1	Violin
	Finger Bass		Viola
	Pick Bass		Cello
	Fretless Bass		Contrabass
	Slap Bass 1		Tremolo Strings
	Slap Bass 2		Pizzicato Strings
	Synth Bass 1		Harp
	Synth Bass 2		Timpani

Category	Tone	Category	Tone
Strings 2	String Ensemble 1 String Ensemble 2 Synth Strings 1 Synth Strings 2 Choir Aahs Voice Oohs Synth Voice Orchestra Hit	Brasses	Trumpet Trombone Tuba Muted Trumpet French Horn Brass Section Synth Brass 1 Synth Brass 2
Reeds	Soprano Sax Alto Sax Tenor Sax Baritone Sax Oboe English Horn Bassoon Clarinet	Flutes/ Pipes	Piccolo Flute Recorder Pan Flute Blown Bottle Shakuhachi Whistle Ocarina
Synth Leads	Square Lead Sawtooth Lead Calliope Lead Chiff Lead Charang Lead Voice Lead Fifth Lead Bass & Lead	Synth Pads	New Age Pad Warm Pad Polysynth Pad Choir Pad Bowed Pad Metallic Pad Halo Pad Sweep Pad

Category	Tone	Category	Tone
Synth Effects	Rain Soundtrack Crystal Atmosphere Brightness Goblins Echoes Science Fiction	Ethnics	Sitar Banjo Shamisen Koto Kalimba Bagpipe Fiddle Shanai
Percussions	Tinkle Bell Agogo Steel Drums Woodblock Taiko Drums Melodic Tom Synth Drum Reverse Cymbal	Effects	Gtr. Fret Noise Breath Noise Seashore Bird Tweet Telephone Ring Helicopter Applause Gunshot

## Extended tones

Category	Tone	Category	Tone
Drums (FM)	SeqClick H	Drums (FM)	Timbale H
	Brush Tap		Timbale L
	Brush Swirl L		Agogo H
	Brush Slap		Agogo L
	Brush Swirl H		Cabasa
	Snare Roll		Maracas
	Castanet		Samba Whistle H
	Sticks		Samba Whistle L
	Open Rim Shot		Guiro Short
	Closed Rim Shot		Guiro Long
	Hand Clap		Claves
	Ride Cymbal Cup		Wood Block H
	Tambourine		Wood Block L
	Cowbell		Cuica Mute
	Vibraslap		Cuica Open
	Bongo H		Triangle Mute
	Bongo L		Triangle Open
	Conga H Mute		Shaker
	Conga H Open		Jingle Bell
	Conga L		Belltree

Category	Tone	Category	Tone
Drums (WT)	Snare L	Drums (WT)	High Tom
	Snare M		Hi-Hat Closed
	Snare H		Hi-Hat Pedal
	Bass Drum L		Hi-Hat Open
	Bass Drum M		Crash Cymbal 1
	Bass Drum H		Crash Cymbal 2
	Floor Tom L		Ride Cymbal 1
	Floor Tom H		Ride Cymbal 2
	Low Tom		Chinese Cymbal
	Mid Tom L		Splash Cymbal
	Mid Tom H		

### To Set the Strength of the Original Ringtone

The strength of the original ringtone can be set in 3 levels for each melody.

When you purchase this phone, the strength of the original ringtone is set to "Loud".

1. Perform steps 1 to 13 in "Creating Your Original Ringtone" on page 127.
2. Press ▲ or ▼ to highlight "Set Strength", then press ●.
3. Press ▲ or ▼ to highlight a strength of the tone. When [Play] is pressed, the original ringtone entered is played back in the selected strength of the tone.
4. Press ●.  
Now you can create an original ringtone.

### Editing Original Ringtones (M 3-7-2)

1. Press ● to display the Main menu.
2. Press ▲, ▼, ◀ or ▶ to highlight "Applications", then press ● to select.
3. Press ▲ or ▼ to highlight "Melody Editor", then press ● to select.
4. Press ▲ or ▼ to highlight "My Sounds", then press ● to select.
5. Press ▲ or ▼ to highlight an original ringtone you wish to edit, then press [Options].  
The Options menu is displayed.
6. Press ▲ or ▼ to highlight "Edit Data", then press ● or [Select] to select.
7. Edit the title, then press ●.
8. Press ▲ or ▼ to highlight a tempo, then press ● to select.
9. Press ▲ or ▼ to highlight the number of voices, then press ● to select.
10. Press ◀ or ▶ to highlight a note you wish to change, then edit notes.  
When you add notes, enter the note correctly on the cursor.

To delete a note, press  [Clear] briefly.

Press and hold  [Clear] to clear all tones.

**11.** When you finish editing, press  [Options] to display the Options menu.

**12.** Press  or  to highlight “Save”, then press  or  [Select] to select.

**13.** Press  or  to highlight “Save to My Stuff”, then press  to select.

**14.** Press  or  to highlight “Overwrite”, then press  to select.



The original ringtone is changed.

If you select “New”, the melody before the correction is not modified. The original ringtone is registered as a new original ringtone.

#### **Note**

- When the number of voices is modified in step 9, the confirmation screen may be displayed. When you press  [Yes], a section of the melody may be deleted.
- When you are going to add notes in step 10, you cannot add any notes if you have already entered 380 notes (for 8 voices melodies), 190 notes (for 16 voices melodies) or 95 notes (for 32 voices melodies).





#### **Tip**

- To delete the continuous melody, press  [Options] and then press  or  [Select] after selecting “Delete after Cursor” or “Delete before Cursor”. You can delete the melody after the cursor or before the cursor.

#### **Copying and Pasting Notes**

You can copy and move a part of the melody to another position.

Only original ringtones or editable melodies can be copied or moved.

1. Perform steps 1 to 9 in “Editing Original Ringtones” on page 134.
2. Press  [Options] to display the Options menu.
3. Press  or  to highlight “Copy” or “Cut”, then press  or  [Select] to select.



4. Press ◀ or ▶ to move the cursor to the first note to be copied or to be cut, then press ●.
5. Press ◀ or ▶ to move the cursor to the last note to highlight the area, then press ●.  
The highlighted area is saved temporarily in the memory. If you select “Cut” in step 3, the highlighted area is cut.
6. Press ⏪ [Options] to display the Options menu.
7. Press ▲ or ▼ to highlight “Paste”, then press ● or ⏩ [Select] to select.
8. Press ◀ or ▶ to move the cursor to the point you wish to paste the notes, then press ●.  
Saved notes are pasted.

### Phone Help (M 3-8)

You can view the help list and use it to guide you in the phone’s functions.

1. Press ● to display the Main menu.
2. Press ▲, ▼, ◀ or ▶ to highlight “Applications”, then press ● to select.
3. Press ▲ or ▼ to highlight “Phone Help”, then press ● to select.  
The help list is displayed.
4. Press ▲ or ▼ to highlight the desired function.
5. When you have finished, press ⏪ [Back].

## Profiles (M 7)









You can easily alter the phone tone (e.g. the ringer volume, keypad tones, etc.) according to your environment.

Tone sound and vibration set can be customised for each profile.

There are 5 profiles including one user definable profile:





- Normal
- Activity
- Car
- Headset
- Silent

### Activating a Profile

1. Press  to display the Main menu.
2. Press , ,  or  to highlight “Profiles”, then press  to select.  
The Profiles screen is displayed.
3. Press  or  to highlight the profile you wish to activate, then press  to select.

### Note

















- When a profile is set, the icon which corresponds to the profile name is displayed in the stand-by screen:

-  **Normal:** Is the default setup (not displayed in the stand-by screen).
-  **Activity:** For use in busy environments.
-  **Car:** For use in the car (connected to a handsfree car kit).
-  **Headset:** For use with a headset (connected via Bluetooth).
-  **Silent:** For use when silence is needed. All sounds are muted and you are alerted to calls with the vibrator.











### Tip

- You can press and hold  for approximately 2 seconds instead of steps 1 and 2 to display the Profiles screen during stand-by.

## Customising Profiles

1. Press  to display the Main menu.
2. Press , ,  or  to highlight “Profiles”, then press  to select.
3. Press  or  to highlight the profile you wish to customise, then press  [Options].
4. Press  or  to highlight “Personalise”, then press  or  [Select] to select.
5. Press  or  to highlight the setting you wish to customise, then press  to select.
6. Change the desired setting.  
For details about settings, see pages 139 to 144.
7. When you have finished, press  [Save] to save the modifications.

## Resetting Profile Settings

1. Perform steps 1 and 2 in “Customising Profiles”.
2. Press  or  to highlight the profile you wish to reset, then press  [Options].
3. Press  or  to highlight “Set to Default”, then press  or  [Select] to select.
4. Enter your handset code, then press .
5. Press  [Yes].  
To cancel resetting, press  [No] in step 5.

### Note

- If you enter a wrong handset code in step 4, the screen returns to step 1.

## Ringer Volume

You can adjust the ringer volume to one of 6 levels or a step tone.

When it is set to “Silent”, the volume of applications is muted.

1. Perform steps 1 to 4 in “Customising Profiles” on page 138.
2. Press ▲ or ▼ to highlight “Ringer Volume”, then press ● to select.

The current volume level is displayed.

3. Press ▲ to increase the ringer volume or press ▼ to decrease the ringer volume and then press ●.  
To select “Step Tone”, press ▲ at level 5.  
To select “Silent”, press ▼ at level 1.

## Assigning Ringtone

You can select the ringtone from 28 tones including 5 patterns, 13 sound effects and 10 melodies. You can also select a sound in the handset memory as the default ringtone excluding the AMR/WAVE and MP3 format.

1. Perform steps 1 to 4 in “Customising Profiles” on page 138.
2. Press ▲ or ▼ to highlight “Assign Ringtone”, then press ● to select.
3. Press ▲ or ▼ to highlight “Preset Sounds” or “My Sounds”, then press ● to select.
4. Press ▲ or ▼ to highlight the ringtone you wish to use.  
If you wish to hear the demo play, press ●.  
To stop playing, press ●.
5. When selection is complete, press ⏏ [Options] to display the Options menu.
6. Press ▲ or ▼ to highlight “Assign”, then press ● or ⏏ [Select] to select.

### Note

- If you delete a ringtone that uses a sound in the handset memory, the default ringtone is set.

## Vibration

When the vibrator option is set on, the phone will vibrate for incoming calls regardless of the ringer volume and tone settings.

1. Perform steps 1 to 4 in “Customising Profiles” on page 138.
2. Press ▲ or ▼ to highlight “Vibration”, then press ● to select.
3. Press ▲ or ▼ to highlight “Enable”, “Disable” or “Link to Sound”, then press ● to select.

### Tip

- When the “Link to Sound” option is selected in step 3, the vibrator synchronises with your selected melody to pulse in time with the melody. Please note that not all melodies support the “Link to Sound” option. Should you select such a melody, only the “Enable” option in step 3 will allow vibrator function.
- When you select “Enable” or “Link to Sound” in step 3, “📱” is displayed on the stand-by screen.

## Light Colour

You can select from 7 colours and 1 pattern for each profile and change it during an incoming call.

1. Perform steps 1 to 4 in “Customising Profiles” on page 138.
2. Press ▲ or ▼ to highlight “Light Colour”, then press ● to select.
3. Press ▲ or ▼ to highlight the desired light colour or pattern, then press ● to select.

### Tip

- If you select “Disco” in step 3, all 7 colours flash in order during an incoming call.

## Keypad Tones

When the keypad tone is set on, you will hear a confirmation tone each time you press any keys.

1. Perform steps 1 to 4 in “Customising Profiles” on page 138.
2. Press ▲ or ▼ to highlight “Keypad Tones”, then press ● to select.

3. Press ▲ or ▼ to highlight “On” or “Off”, then press ● to select.  
If you select “Off”, the screen returns to step 1.
4. Press ▲ or ▼ to highlight “Volume”, then press ● to select.
5. Press ▲ to increase the volume or press ▼ to decrease the volume, then press ●.
6. Press ▲ or ▼ to highlight “Tone”, then press ● to select.
7. Press ▲ or ▼ to highlight either “Preset Sounds”, “My Sounds” or “Default Tone”, then press ● to select.  
If you select “Preset Sounds” or “My Sounds” in step 7, perform the following, otherwise go to step 9.
8. Select the keypad tone.  
For details on selecting a ringtone, see “Assigning Ringtone” on page 139.
9. Press ▲ or ▼ to highlight “Duration”, then press ● to select.
10. Press ▲ or ▼ to highlight the desired duration, then press ● to select.

## Warning Tone

This function enables your phone to emit the warning tone when an error occurs.

1. Perform steps 1 to 4 in “Customising Profiles” on page 138.
2. Press ▲ or ▼ to highlight “Warning Tone”, then press ● to select.
3. Press ▲ or ▼ to highlight “On” or “Off”, then press ● to select.  
If you select “Off”, the screen returns to step 1.
4. Press ▲ or ▼ to highlight “Volume”, then press ● to select.
5. Press ▲ to increase the volume or press ▼ to decrease the volume, then press ●.
6. Press ▲ or ▼ to highlight “Tone”, then press ● to select.
7. Press ▲ or ▼ to highlight “Preset Sounds” or “My Sounds”, then press ● to select.
8. Select the warning tone.  
For details on selecting a ringtone, see “Assigning Ringtone” on page 139.
9. Press ▲ or ▼ to highlight “Duration”, then press ● to select.

10. Press ▲ or ▼ to highlight the desired duration, then press ● to select.

## Power On/Off Sound

The phone can be set up to emit a sound when it is switched on or off. You can define the volume, duration and the melody to be used for this task.

1. Perform steps 1 to 4 in “Customising Profiles” on page 138.
2. Press ▲ or ▼ to highlight “Power On Sound” or “Power Off Sound”, then press ● to select.
3. Press ▲ or ▼ to highlight “On” or “Off”, then press ● to select.  
If you select “Off”, the screen returns to step 1.
4. Press ▲ or ▼ to highlight “Volume”, then press ● to select.
5. Press ▲ to increase the volume or press ▼ to decrease the volume and then press ●.
6. Press ▲ or ▼ to highlight “Sound”, then press ● to select.
7. Press ▲ or ▼ to highlight “Preset Sounds” or “My Sounds”, then press ● to select.

8. Select the ringtone.

For details on selecting a ringtone, see “Assigning Ringtone” on page 139.

9. Press ▲ or ▼ to highlight “Duration”, then press ● to select.
10. Enter the desired duration of the ringtone in 2 digits (01 to 10 seconds) using the digit keys, then press ●.

## Message Alert

When receiving messages, special ringtones can be set.

1. Perform steps 1 to 4 in “Customising Profiles” on page 138.
2. Press ▲ or ▼ to highlight “Message Alert”, then press ● to select.
3. Press ▲ or ▼ to highlight “Multimedia”, “Text” or “WAP”, then press ● to select.
4. Press ▲ or ▼ to highlight “Volume”, then press ● to select.

5. Press ▲ to increase the volume or press ▼ to decrease the volume and then press ●.
6. Press ▲ or ▼ to highlight “Sound”, then press ● to select.
7. Press ▲ or ▼ to highlight “Preset Sounds” or “My Sounds”, then press ● to select.
8. Select the ringtone.  
For details on selecting a ringtone, see “Assigning Ringtone” on page 139.
9. Press ▲ or ▼ to highlight “Vibration”, then press ● to select.
10. Press ▲ or ▼ to highlight “Enable”, “Disable” or “Link to Sound”, then press ● to select.
11. Press ▲ or ▼ to highlight “Duration”, then press ● to select.
12. Enter the duration of ringtone in 2 digits (01 to 15 seconds) using the digit keys, then press ●.

## Low Battery Alert

Adjust the volume of the alarm when the battery becomes low.

1. Perform steps 1 to 4 in “Customising Profiles” on page 138.
2. Press ▲ or ▼ to highlight “Low Battery Alert”, then press ● to select.
3. Press ▲ or ▼ to highlight “High”, “Low” or “Silent”, then press ●.



## Echo Reduction







This function is for reducing irritating echoes, especially when using the handsfree car kit.

1. Perform steps 1 to 4 in “Customising Profiles” on page 138.
2. Press ▲ or ▼ to highlight “Echo Reduction”, then press ● to select.
3. Press ▲ or ▼ to highlight “On” or “Off”, then press ● to select.



## Any Key Answer

You can also answer a call by pressing any key except  or  [Busy]. For details, see page 26.



















1. Perform steps 1 to 4 in “Customising Profiles” on page 138.
2. Press  or  to highlight “Any Key Answer”, then press  to select.
3. Press  or  to highlight “On” or “Off”, then press  to select.

## **Contacts (M 8)**





### **Call Log (M 8-3)**

The phone will record the last 10 missed calls, received calls and dialled numbers.











#### **Viewing Call Log**

1. Press  to display the Main menu.
2. Press , ,  or  to highlight “Contacts”, then press  to select.
3. Press  or  to highlight “Call Log”, then press  to select.
4. Press  or  to highlight “Missed Calls”, “Received Calls” or “Dialled Numbers”, then press  to select.  
The selected call log list is displayed.
5. Press  or  to highlight the number you wish to view, then press  to select.  
If you wish to dial the number, press .  
Call log “1” is the most recent. When you press , call log “2” is displayed.
6. When you have finished viewing, press  [Back] to return to step 4.

#### **Tip**

- You can also confirm call logs by pressing  during stand-by mode.
- You can switch between histories by pressing  or  in step 5 only when you enter by  in stand-by mode.

#### **Sending Messages**

1. Perform steps 1 to 5 in “Viewing Call Log”.
2. Press  or  to highlight the call log you wish to send, then press  to select.  
The selected call record is displayed in detail.
3. Press  [Options] to display the Options menu.
4. Press  or  to highlight “Create Message”, then press  or  [Select] to select.
5. Press  or  to highlight “Multimedia” or “Text”, then press  to select.
6. Enter your message.  
For details on creating a message, see “Creating a New MMS” on page 66 or “Creating a New SMS” on page 78.

## Deleting a Call Log

### To Delete a Single Call Log

1. Perform steps 1 to 5 in “Viewing Call Log” on page 145.
2. Press ▲ or ▼ to highlight the call log you wish to delete, then press ● to select.

The selected call log is displayed in detail.

3. Press ▢ [Options] to display the Options menu.
4. Press ▲ or ▼ to highlight “Delete”, then press ● or ▢ [Select] to select.
5. Press ▢ [Yes].

The selected call log is deleted.

To cancel deletion, press ▢ [No] in step 5.

## Call Timers (M 8-3-4)

This function lets you check the duration of your calls.

### Checking the Duration of the Last Call

1. Press ● to display the Main menu.
2. Press ▲, ▼, ◀ or ▶ to highlight “Contacts”, then press ● to select.
3. Press ▲ or ▼ to highlight “Call Log”, then press ● to select.
4. Press ▲ or ▼ to highlight “Call Timers”, then press ● to select.
5. Press ▲ or ▼ to highlight “Received Calls” or “Dialled Numbers”, then press ● to select.
6. Press ▲ or ▼ to highlight “Last Call”, then press ● to select.

The duration of the last call is now displayed.

7. When you have finished, press ▢ [Back] to return to call timers menu.

### Checking the Total Call Time

1. Perform steps 1 to 4 in “Checking the Duration of the Last Call” on page 146.
2. Press ▲ or ▼ to highlight “Received Calls” or “Dialled Numbers”, then press ● to select.
3. Press ▲ or ▼ to highlight “All Calls”, then press ● to select.
4. When you have finished, press ⏪ [Back].

### Resetting All Call Timers

1. Perform steps 1 to 4 in “Checking the Duration of the Last Call” on page 146.
2. Press ▲ or ▼ to highlight “Clear Timers”, then press ● to select.
3. Enter your handset code, then press ●.
4. Press ⏩ [Yes].  
The Call Timers are reset to zero.  
To cancel resetting, press ⏪ [No] in step 4.

### Call Costs (M 8-3-5)

This function lets you check the charges for your calls.  
**Some networks do not support Charging Advice.**  
**Please check with your service provider for availability.**

### Checking the Cost of the Last Call

1. Press ● to display the Main menu.
2. Press ▲, ▼, ⏪ or ⏩ to highlight “Contacts”, then press ● to select.
3. Press ▲ or ▼ to highlight “Call Log”, then press ● to select.
4. Press ▲ or ▼ to highlight “Call Costs”, then press ● to select.
5. Press ▲ or ▼ to highlight “Last Call”, then press ● to select.  
The cost of the last call is now displayed.
6. When you have finished, press ⏪ [Back] to return to call costs menu.

### Checking the Total Call Cost

1. Perform steps 1 to 4 in “Checking the Cost of the Last Call” on page 147.
2. Press ▲ or ▼ to highlight “All Calls”, then press ● to select.
3. When you have finished, press ⏪ [Back].

### Setting the Charge Rate

Set the charge rate to calculate the call cost and set the maximum limit for call cost.

1. Perform steps 1 to 4 in “Checking the Cost of the Last Call” on page 147.
2. Press ▲ or ▼ to highlight “Cost Units”, then press ● to select.
3. Press ▲ or ▼ to highlight “Set Units”, then press ● to select.
4. Enter your PIN2 code, then press ●.
5. Enter a cost per unit, then press ●.  
To enter a decimal point, press #.
6. Enter a currency unit (up to 3 characters), then press ●.

### Checking the Charge Rate

1. Perform steps 1 to 4 in “Checking the Cost of the Last Call” on page 147.
2. Press ▲ or ▼ to highlight “Cost Units”, then press ● to select.
3. Press ▲ or ▼ to highlight “Read Units”, then press ● to select.  
The charge rate is now displayed.
4. When you have finished, press ⏪ [Back].

### Setting the Charge Limit

This function is useful if you wish to make sure you do not exceed a certain charge limit.

1. Perform steps 1 to 4 in “Checking the Cost of the Last Call” on page 147.
2. Press ▲ or ▼ to highlight “Max Cost”, then press ● to select.
3. Press ▲ or ▼ to highlight “Set Limit”, then press ● to select.
4. Enter your PIN2 code, then press ●.
5. Enter a value, then press ●.  
To enter a decimal point, press #.

### Checking the Charge Limit

1. Perform steps 1 to 4 in “Checking the Cost of the Last Call” on page 147.
2. Press ▲ or ▼ to highlight “Max Cost”, then press ● to select.
3. Press ▲ or ▼ to highlight “Read Limit”, then press ● to select.  
The value of the charge limit is displayed.
4. When you have finished, press ⏪ [Back].

### Resetting All Call Costs

















1. Perform steps 1 to 4 in “Checking the Cost of the Last Call” on page 147.
2. Press ▲ or ▼ to highlight “Clear Costs”, then press ● to select.
3. Enter your PIN2 code, then press ●.
4. Press ⏪ [Yes].  
The Call Costs are reset to zero.  
To cancel resetting, press ⏪ [No] in step 4.

### Checking the Residual Credit





1. Perform steps 1 to 4 in “Checking the Cost of the Last Call” on page 147.
2. Press ▲ or ▼ to highlight “Residual Credit”, then press ● to select.
3. When you have finished, press ⏪ [Back].

## Data Counter (M 8-3-6)

You can confirm the amount of bytes which you used in the GPRS transmission.

1. Press  to display the Main menu.
2. Press , ,  or  to highlight “Contacts”, then press  to select.
3. Press  or  to highlight “Call Log”, then press  to select.
4. Press  or  to highlight “Data Counter”, then press  to select.
5. Press  or  to highlight “Last Data” or “All Data”, then press  to select.  
You can now check the amount of bytes.
6. When you have finished, press  [Back].

### Resetting All Data Counter









1. Perform steps 1 to 4 in “Data Counter”.
2. Press  or  to highlight “Clear Counter”, then press  to select.
3. Press  [Yes].

The Data Counter is reset to zero.

To cancel resetting, press  [No] in step 3.











## Speed Dial List (M 8-4)

You can view and perform other operations for phone numbers registered in the Speed Dial List.

1. Press  to display the Main menu.
2. Press , ,  or  to highlight “Contacts”, then press  to select.
3. Press  or  to highlight “Speed Dial List”, then press  to select.

The names and phone numbers stored in the Speed Dial List are displayed in order.

### Registering the Phone Numbers in the Speed Dial List













1. Perform steps 1 to 3 in “Speed Dial List”.
2. Press  or  to highlight the phone number you wish to register in the Speed Dial List.
3. Press  [Options] to display the Options menu.
4. Press  or  to highlight “Assign” (or “Re-assign”), then press  or  [Select] to select.
5. Press  or  to highlight the name you wish to register in the Speed Dial List, then press .

**Tip**

- You can select other options in step 4:  
“Delete”: Deletes the selected entry.  
“Clear All”: Clears all registered entries.

## **My Numbers (M 8-5)**

You can check your own voice, data and fax phone numbers.

1. Press  to display the Main menu.
2. Press , ,  or  to highlight “Contacts”, then press  to select.
3. Press  or  to highlight “My Numbers”, then press  to select.
4. Press  or  to highlight the phone number you wish to check from either “Voice”, “Data” or “Fax”, then press  to select.

**Note**









- “Data” or “Fax” may not be displayed depending on the SIM card.



## **Settings (M 9)**







### **Phone Settings (M 9-1)**

#### **Opening the Phone Settings Screen**

1. Press  to display the Main menu.
2. Press , ,  or  to highlight “Settings”, then press  to select.
3. Press  or  to highlight “Phone Settings”, then press  to select.  
The Phone Settings screen is displayed. The following settings can be made.

#### **Changing the Language (M 9-1-1)**

You can change the language that the phone uses to display messages.

1. Perform steps 1 to 3 in “Opening the Phone Settings Screen”.
2. Press  or  to highlight “Language”, then press  to select.
3. Press  or  to highlight the desired language, then press  to select.

#### **Tip**







- You can also change the input language on the text entry screen. (p. 33)

#### **Note**

- If you select “Automatic” in step 3, the language preset on the SIM card is selected.
- If the language preset on the SIM card is not supported, then the default language of the phone is selected.

#### **Date & Time (M 9-1-2)**

You need to set the correct time and date in order for your phone’s various time-based functions to work correctly.

1. Perform steps 1 to 3 in “Opening the Phone Settings Screen”.
2. Press  or  to highlight “Date & Time”, then press  to select.
3. Press  or  to highlight “Set Date/Time”, then press  to select.
4. Enter the day, month, year and time using the digit keys, then press .

When you enter the time in the 12-hour format, press  to switch between am and pm.

The order in which the date and time is displayed is based on the format setting. See “To Select the Date Format” on page 153.

### To Select the Time System

1. Perform steps 1 to 3 in “Opening the Phone Settings Screen” on page 152.
2. Press ▲ or ▼ to highlight “Date & Time”, then press ● to select.
3. Press ▲ or ▼ to highlight “Clock Settings”, then press ● to select.
4. Press ▲ or ▼ to highlight “Time Format”, then press ● to select.
5. Press ▲ or ▼ to highlight “12 hour” or “24 hour”, then press ● to select.

### To Select the Date Format

The date format can be switched between “Day.Month.Year”, “Month-Day-Year” or “Year/Month/Day”.

1. Perform steps 1 to 3 in “Opening the Phone Settings Screen” on page 152.
2. Press ▲ or ▼ to highlight “Date & Time”, then press ● to select.
3. Press ▲ or ▼ to highlight “Clock Settings”, then press ● to select.
4. Press ▲ or ▼ to highlight “Date Format”, then press ● to select.

5. Press ▲ or ▼ to highlight “D.M.Y”, “M-D-Y” or “Y/M/D”, then press ● to select.

### To Set the Clock Display

1. Perform steps 1 to 3 in “Opening the Phone Settings Screen” on page 152.
2. Press ▲ or ▼ to highlight “Date & Time”, then press ● to select.
3. Press ▲ or ▼ to highlight “Clock Settings”, then press ● to select.
4. Press ▲ or ▼ to highlight “Display Format”, then press ● to select.
5. Press ▲ or ▼ to highlight “Time Only”, “Date Only” or “Date & Time”, then press ● to select.  
To set hide clock, select “Off” in step 5, then press ●.

### To Set Daylight Saving Time

You can switch to daylight saving time without having to change the clock time itself.

1. Perform steps 1 to 3 in “Opening the Phone Settings Screen” on page 152.
2. Press ▲ or ▼ to highlight “Date & Time”, then press ● to select.
3. Press ▲ or ▼ to highlight “Clock Settings”, then press ● to select.
4. Press ▲ or ▼ to highlight “Daylight Saving”, then press ● to select.
5. Press ▲ or ▼ to highlight “On”, then press ● to select.

### To Set the Time Zone

1. Perform steps 1 to 3 in “Opening the Phone Settings Screen” on page 152.
2. Press ▲ or ▼ to highlight “Date & Time”, then press ● to select.
3. Press ▲ or ▼ to highlight “Set Time Zone”, then press ● to select.
4. Press ▲ or ▼ to highlight “Change Zone”, then press ● to select.
5. Press ◀ or ▶ to set the home city, then press ●.

### To Customise the Time Zone

1. Perform steps 1 to 3 in “Opening the Phone Settings Screen” on page 152.
2. Press ▲ or ▼ to highlight “Date & Time”, then press ● to select.
3. Press ▲ or ▼ to highlight “Set Time Zone”, then press ● to select.

4. Press ▲ or ▼ to highlight “Set Custom Zone”, then press ● to select.
5. Enter the time-zone differences using the digit keys, then press ●.
 

Each press of [\*+0] switches – and +.

### Setting the Main Display (M 9-1-3)

You can change the settings of the Main Display.

#### Wallpaper for the Main Display

For the stand-by screen of the main display, 3 pictures are provided.

Pictures taken with the digital camera or images downloaded from a WAP site can be used for wallpapers.

#### To Set Built-in Pictures of the Main Display

1. Perform steps 1 to 3 in “Opening the Phone Settings Screen” on page 152.
2. Press ▲ or ▼ to highlight “Main Display”, then press ● to select.
3. Press ▲ or ▼ to highlight “Wallpaper”, then press ● to select.
4. Press ▲ or ▼ to highlight “Preset Pictures”, then press ● to select.

5. Press ▲ or ▼ to highlight the desired picture, then press ● to select.
 

The selected picture is displayed.
6. Press ● to set.
 

The selected picture is set.

#### Tip

- To cancel the Wallpaper setting, select “Off” in step 4.

#### To Set My Pictures for the Main Display

1. Perform steps 1 to 3 in “Opening the Phone Settings Screen” on page 152.
2. Press ▲ or ▼ to highlight “Main Display”, then press ● to select.
3. Press ▲ or ▼ to highlight “Wallpaper”, then press ● to select.
4. Press ▲ or ▼ to highlight “My Pictures”, then press ● to select.
5. Press ▲ or ▼ to highlight “Handset Memory” or “Memory Card”, then press ● to select.
 

The file names of the pictures that are registered in the selected memory are displayed.

6. Press ▲ or ▼ to highlight the picture, then press ● to select.  
The selected picture is displayed.
7. Press ●.
8. Press ▲, ▼, ◀ or ▶ to specify the area you wish to display, then press ●.  
The selected picture is set.

**Note**

- Some pictures cannot be used because of their picture and data types.
- Even if an animation is selected, the stand-by screen displays a still picture when you do not operate the phone for about 30 seconds (Differs according to the selected data).

**Backlight**

You can turn the backlight of the main display on or off when you press the keypad or the optional cigarette lighter charger is connected to the phone.

You can change or specify the amount of time (1 to 99 seconds) the backlight is on for, which will help conserve battery life.

**Tip**

- When you purchase this phone, Backlight is set to 15 seconds.

**To Turn On/Off the Backlight**













1. Perform steps 1 to 3 in “Opening the Phone Settings Screen” on page 152.
2. Press ▲ or ▼ to highlight “Main Display”, then press ● to select.
3. Press ▲ or ▼ to highlight “Backlight”, then press ● to select.
4. Press ▲ or ▼ to highlight “On/Off”, then press ● to select.
5. Press ▲ or ▼ to highlight “On” to set backlight on or “Off” to set backlight off, then press ● to select.

When you select “On” in step 5:

6. Enter the duration of the backlight using 2 digits, then press .









#### To Turn On/Off the Backlight whilst Charging with the Cigarette Lighter Charger

With this setting On, the phone’s backlight is on when the cigarette lighter charger is connected. (The backlight of the external display is on, when the phone is closed.)

1. Perform steps 1 to 3 in “Opening the Phone Settings Screen” on page 152.
2. Press  or  to highlight “Main Display”, then press  to select.
3. Press  or  to highlight “Backlight”, then press  to select.
4. Press  or  to highlight “In Car”, then press  to select.
5. Press  or  to highlight “On” to set backlight on or “Off” to set backlight off, then press .

#### Adjusting the Brightness of the Backlight

You can adjust the brightness of the backlight of the main display from 4 levels.

1. Perform steps 1 to 3 in “Opening the Phone Settings Screen” on page 152.
2. Press  or  to highlight “Main Display”, then press  to select.
3. Press  or  to highlight “Brightness”, then press  to select.
4. Press  (Light) or  (Dark) to adjust the brightness for maximum clarity.
5. Press .

#### Note

- *The brightness of the backlight above does not affect the brightness of the external display.*

### Setting the Display Saving

This phone's screen will automatically turn off after a given amount of time if the phone is left open. This is in order to conserve battery life.

You can change the time before the Display Saving will go into effect from between 2 and 20 minutes.

#### Tip

• *When you purchase this phone, Display Saving is set to 10 minutes.*

1. Perform steps 1 to 3 in "Opening the Phone Settings Screen" on page 152.
2. Press ▲ or ▼ to highlight "Main Display", then press ● to select.
3. Press ▲ or ▼ to highlight "Display Saving", then press ● to select.
4. Enter the time before Display Saving takes effect in two digits (02 to 20 minutes) using the digit keys, then press ●.

#### Note

• *Display Saving does not work whilst you are calling, using WAP, or using an application.*

### To Cancel the Display Saving Function

The display saving continues until either a key is pressed or there is an incoming alert. The first key press only cancels the Display Saver. You must press another key in order to input any numerical or text value.

### Setting the Greeting Message

You can set the message which will appear when the phone is turned on.

1. Perform steps 1 to 3 in "Opening the Phone Settings Screen" on page 152.
2. Press ▲ or ▼ to highlight "Main Display", then press ● to select.
3. Press ▲ or ▼ to highlight "Greeting Message", then press ● to select.
4. Press ▲ or ▼ to highlight "On", then press ● to select.
5. Enter the message, then press ●.

Up to 16 characters can be stored as a message. For details on entering characters, see "Entering Characters" on page 32.

#### Tip

• *To cancel the Greeting Message setting, select "Off" in step 4.*

## Assigning the Pictures

Pictures can be displayed when turning the power on or off, when receiving an incoming call, or when operating the alarm.

Pictures taken by a digital camera or images downloaded from a WAP site can be used.

### To Set Built-in Pictures

1. Perform steps 1 to 3 in “Opening the Phone Settings Screen” on page 152.
2. Press ▲ or ▼ to highlight “Main Display”, then press ● to select.
3. Press ▲ or ▼ to highlight “Assign Pictures”, then press ● to select.
4. Press ▲ or ▼ to highlight the screen to set the picture, then press ● to select.
5. Press ▲ or ▼ to highlight “Animation 1” or “Animation 2”, then press ● to select when you select “Power On” or “Power Off” in step 4. Or press ▲ or ▼ to highlight “Pattern 1” or “Pattern 2”, then press ● to select when you select “Incoming” or “Alarm” in step 4.

The selected animation or picture is displayed.

6. Press ● to set.

### Tip

- To cancel the picture setting, select “Default”, then press ● in step 5.



### To Set My Pictures

1. Perform steps 1 to 3 in “Opening the Phone Settings Screen” on page 152.
2. Press ▲ or ▼ to highlight “Main Display”, then press ● to select.
3. Press ▲ or ▼ to highlight “Assign Pictures”, then press ● to select.
4. Press ▲ or ▼ to highlight the screen to set the picture, then press ● to select.
5. Press ▲ or ▼ to highlight “My Pictures”, then press ● to select.
6. Press ▲ or ▼ to highlight “Handset Memory” or “Memory Card”, then press ● to select.  
The file name of the pictures that are registered in the selected memory is displayed.
7. Press ▲ or ▼ to highlight the picture, then press ● to select.  
The selected picture is displayed.
8. Press ▲, ▼, ◀ or ▶ to specify the area you wish to display, then press ●.

#### **Note**

- Some pictures cannot be used because of their picture and data types.

### Setting the External Display (M 9-1-4)

You can change the settings of the external display.

#### To Turn On/Off the External Display

You can turn the external display on or off when the phone is closed.

1. Perform steps 1 to 3 in “Opening the Phone Settings Screen” on page 152.
2. Press ▲ or ▼ to highlight “External Display”, then press ● to select.
3. Press ▲ or ▼ to highlight “LCD On/Off”, then press ● to select.
4. Press ▲ or ▼ to highlight “On” to set external display on or “Off” to set external display off, then press ● to select.

#### Wallpaper for the External Display

For the stand-by screen of the external display, 3 pictures are provided.

Pictures taken with the digital camera or images downloaded from a WAP site can be used for wallpapers.

### To Set Built-in Pictures of the External Display

1. Perform steps 1 to 3 in “Opening the Phone Settings Screen” on page 152.
2. Press ▲ or ▼ to highlight “External Display”, then press ● to select.
3. Press ▲ or ▼ to highlight “Wallpaper”, then press ● to select.
4. Press ▲ or ▼ to highlight “Preset Pictures”, then press ● to select.
5. Press ▲ or ▼ to highlight the desired picture, then press ● to select.  
The selected picture is displayed.
6. Press ● to set.  
The selected picture is set.

#### **Tip**

- To cancel the Wallpaper setting, select “Off” in step 4.

### To Set My Pictures for the External Display

1. Perform steps 1 to 3 in “Opening the Phone Settings Screen” on page 152.
2. Press ▲ or ▼ to highlight “External Display”, then press ● to select.
3. Press ▲ or ▼ to highlight “Wallpaper”, then press ● to select.
4. Press ▲ or ▼ to highlight “My Pictures”, then press ● to select.
5. Press ▲ or ▼ to highlight “Handset Memory” or “Memory Card”, then press ● to select.  
The file names of the pictures that are registered in the selected memory are displayed.
6. Press ▲ or ▼ to highlight the picture, then press ● to select.  
The selected picture is displayed.
7. Press ●.
8. Press ▲, ▼, ◀ or ▶ to specify the area you wish to display, then press ●.  
The selected picture is set.

### **Note**

- *Some pictures cannot be used because of their picture and data types.*
- *Even if an animation is selected, the stand-by screen displays a still picture when you do not operate the phone for about 2 minutes.*
- *When an animation is set as the wallpaper of the external display, the battery consumes large amounts of power and stand-by time may be shortened. To use the battery for a long time, set a still picture for wallpaper for external display or set the wallpaper of the external display setting off.*

### **To Turn On/Off the Backlight of the External Display**

You can turn the backlight of the external display on or off when the phone is closed.

You can also change or specify the duration of the external display backlight (1 to 99 seconds).

### **Tip**

- *When you purchase this phone, Backlight is set to 15 seconds.*

1. Perform steps 1 to 3 in “Opening the Phone Settings Screen” on page 152.
2. Press ▲ or ▼ to highlight “External Display”, then press ● to select.
3. Press ▲ or ▼ to highlight “Backlight”, then press ● to select.
4. Press ▲ or ▼ to highlight “On” to set backlight on or “Off” to set backlight off, then press ● to select.

When you select “On” in step 4:

5. Enter the duration of the backlight using 2 digits, then press ●.

### To Adjust the LCD Contrast of the External Display

You may sometimes need to adjust the LCD contrast of the external display to suit certain lighting conditions.

1. Perform steps 1 to 3 in “Opening the Phone Settings Screen” on page 152.
2. Press ▲ or ▼ to highlight “External Display”, then press ● to select.
3. Press ▲ or ▼ to highlight “LCD Contrast”, then press ● to select.
4. Press ▲ (High) or ▼ (Low) to adjust the contrast for maximum clarity.  
LCD contrast can be adjusted to 9 levels.
5. Press ●.

### To Set Incoming Indication

Illustrations can be displayed on the external display when receiving an incoming call.

1. Perform steps 1 to 3 in “Opening the Phone Settings Screen” on page 152.
2. Press ▲ or ▼ to highlight “External Display”, then press ● to select.
3. Press ▲ or ▼ to highlight “Incoming Indication”, then press ● to select.
4. Press ▲ or ▼ to highlight an illustration from “Illustration 1” to “Illustration 4”, then press ● to select.  
The selected picture is displayed.
5. Press ●.

### To Display the Clock on the External Display

You can set the digital/analogue clock to be displayed on the external display.

1. Perform steps 1 to 3 in “Opening the Phone Settings Screen” on page 152.
2. Press ▲ or ▼ to highlight “External Display”, then press ● to select.
3. Press ▲ or ▼ to highlight “Clock Display”, then press ● to select.

4. Press ▲ or ▼ to highlight “Digital Clock 1” to “Digital Clock 3” or “Analogue Clock 1” to “Analogue Clock 3”, then press ● to select.  
The selected picture is displayed.
5. Press ●.

**Note**

- *The clock display setting for the external display depends on the setting in “To Set the Clock Display” on page 153.*

**To Display Icons on the External Display**

You can set to display icons on the external display.

1. Perform steps 1 to 3 in “Opening the Phone Settings Screen” on page 152.
2. Press ▲ or ▼ to highlight “External Display”, then press ● to select.
3. Press ▲ or ▼ to highlight “Icon Display”, then press ● to select.
4. Press ▲ or ▼ to highlight “On” to set icon display on or “Off” to set icon display off, then press ● to select.

**Phone Setting Reset (M 9-1-5)**

The phone settings can be reset to their default settings.

1. Perform steps 1 to 3 in “Opening the Phone Settings Screen” on page 152.
2. Press ▲ or ▼ to highlight “Set to Default”, then press ● to select.
3. Enter your handset code, then press ●.
4. Press ⏏ [Yes].  
To cancel resetting, press ⏏ [No] in step 4.









**Note**

- *If you enter a wrong handset code in step 3, the operation is cancelled.*

## Call Settings (M 9-2)

Set various types of functions and services.







### Opening the Call Settings Screen

1. Press  to display the Main menu.
2. Press , ,  or  to highlight “Settings”, then press  to select.
3. Press  or  to highlight “Call Settings”, then press  to select.

The Call Settings screen is displayed. The following settings can be made.

### Call Waiting (M 9-2-1)







If you wish to be able to receive another incoming call whilst you have a call in progress, you must activate the Call Waiting service.

1. Perform steps 1 to 3 in “Opening the Call Settings Screen”.
2. Press  or  to highlight “Call Waiting”, then press  to select.
3. Press  or  to highlight “On” to activate the Call Waiting service or “Off” to deactivate it, then press  to select.
4. Press .

### Note

- *The Call Waiting service may not be available on all mobile phone networks. Contact your network operator for more information.*

### To Check the Call Waiting Service Status

1. Perform steps 1 to 3 in “Opening the Call Settings Screen”.
2. Press  or  to highlight “Call Waiting”, then press  to select.
3. Press  or  to highlight “Status”, then press  to select.

Now you can check the status of the Call Waiting service.

4. Press  [Back].

### Displaying Call Timers (M 9-2-2)

1. Perform steps 1 to 3 in “Opening the Call Settings Screen” on page 165.
2. Press ▲ or ▼ to highlight “Display Call Timers”, then press ● to select.
3. Press ▲ or ▼ to highlight “On” or “Off”, then press ● to select.

### Showing Your Phone Number (M 9-2-3)

This lets you control whether to show your phone number when calling another party or not.

Some networks do not support this service. Please check with your service provider for availability.

1. Perform steps 1 to 3 in “Opening the Call Settings Screen” on page 165.
2. Press ▲ or ▼ to highlight “Show Your Number”, then press ● to select.
3. Press ▲ or ▼ to highlight “On” to show your phone number or “Off” not to show your phone number, then press ● to select.

### To Check the Show Your Number Status

1. Perform steps 1 to 3 in “Opening the Call Settings Screen” on page 165.
2. Press ▲ or ▼ to highlight “Show Your Number”, then press ● to select.
3. Press ▲ or ▼ to highlight “Status”, then press ● to select.

Now you can check the status of the “Show Your Number”.

4. Press ●.

### Adjusting Earpiece Volume (M 9-2-4)

You can adjust the earpiece volume.

1. Perform steps 1 to 3 in “Opening the Call Settings Screen” on page 165.
2. Press ▲ or ▼ to highlight “Earpiece Volume”, then press ● to select.
3. Press ▲ to increase the earpiece volume or press ▼ to decrease the earpiece volume, then press ●.

### **Picture Call (M 9-2-5)**

The image registered to the caller in the Contacts List is displayed when receiving a call.

1. Perform steps 1 to 3 in “Opening the Call Settings Screen” on page 165.
2. Press ▲ or ▼ to highlight “Picture Call”, then press ● to select.
3. Press ▲ or ▼ to highlight “On” or “Off”, then press ● to select.

### **Auto Redial (M 9-2-6)**

See “Automatic Redialling” on page 25 about this function.

### **Auto Answer (M 9-2-7)**

Auto Answer function allows you to answer calls automatically by connecting the handsfree car kit for Bluetooth to your phone via Bluetooth. You can select the desired time until your phone answers.

1. Perform steps 1 to 3 in “Opening the Call Settings Screen” on page 165.
2. Press ▲ or ▼ to highlight “Auto Answer”, then press ● to select.

3. Press ▲ or ▼ to highlight the desired duration, then press ● to select.  
To disable the auto answer function, select “Off” in step 3.

### **Minute Minder (M 9-2-8)**

Minute Minder function informs you of your talk time by sounding a tone after every minute.

1. Perform steps 1 to 3 in “Opening the Call Settings Screen” on page 165.
2. Press ▲ or ▼ to highlight “Minute Minder”, then press ● to select.
3. Press ▲ or ▼ to highlight “On” or “Off”, then press ● to select.

### **Call Setting Reset (M 9-2-9)**

The call settings can be reset to their default settings.

1. Perform steps 1 to 3 in “Opening the Call Settings Screen” on page 165.
2. Press ▲ or ▼ to highlight “Set to Default”, then press ● to select.
3. Enter your handset code, then press ●.
4. Press [Yes].  
To cancel resetting, press [No] in step 4.















### **Note**

- *If you enter the wrong handset code in step 3, the operation is cancelled and the screen returns to step 3 in “Call Waiting” on page 165.*

## **Diverts (M 9-3)**

This service is used to divert incoming calls to your voice mail system or to another number depending on certain conditions in which you cannot answer a call.

### **Diverting Calls**

1. Press  to display the Main menu.
2. Press , ,  or  to highlight “Settings”, then press  to select.
3. Press  or  to highlight “Diverts”, then press  to select.
4. Press  or  to highlight one of the divert options, then press  to select.

The divert options available are:

- “All Calls”: Diverts all voice calls without ringing.
- “When Busy”: Diverts incoming calls when you are on a call.
- “No Answer”: Diverts incoming calls if you do not answer a call within a certain period of time.
- “Not Reachable”: Diverts incoming calls when your phone is out of network service or switched off.

5. Press ▲ or ▼ to highlight “On”, then press ● to select.
  6. If you wish to divert calls to a number which is located in the Contacts List, search for the desired Contacts List entry.  
Press ▲ or ▼ to display the Contacts List. Then press ▲ or ▼ to highlight the desired entry, then press ● to select. For details on searching the Contacts List entries, perform steps 1 to 4 in “Finding a Name and Number” on page 43.
  7. If you wish to divert calls to a number which you can enter manually, enter the phone number.
  8. Press ●.
- If you select “No Answer” in step 4:
9. Press ▲ or ▼ to highlight the period of time from 6 levels (05 to 30 seconds), then press ● to select.

**Note**

- When a divert is set to “All Calls”, “☎” is displayed on the stand-by screen.

**Tip**

- If you select “By Service” in step 5, you can select further divert options in the selected option in step 4.

**Checking the Divert Status**

1. Perform steps 1 to 3 in “Diverting Calls” on page 168.
2. Press ▲ or ▼ to highlight the divert option you wish to check, then press ● to select.
3. Press ▲ or ▼ to highlight “Status”, then press ● to select.  
You can now check the status of the selected divert option.
4. When you have finished, press ⏪ [Back].

**Cancelling All Divert Settings (M 9-3-5)**

1. Perform steps 1 to 3 in “Diverting Calls” on page 168.
2. Press ▲ or ▼ to highlight “Cancel All”, then press ● to select.
3. Press ⏩ [Yes].  
All divert settings are cancelled.  
To cancel resetting, press ⏪ [No] in step 3.

### To Cancel the Divert Settings Individually

1. Perform steps 1 to 3 in “Diverting Calls” on page 168.
2. Press ▲ or ▼ to highlight the divert option you wish to cancel, then press ● to select.
3. Press ▲ or ▼ to highlight “Off”, then press ● to select.

The selected divert has been cancelled.

## Memory Card (M 9-4)

### Formatting Memory Cards (M 9-4-1)

1. Press ● to display the Main menu.
2. Press ▲, ▼, ◀ or ▶ to highlight “Settings”, then press ● to select.
3. Press ▲ or ▼ to highlight “Memory Card”, then press ● to select.
4. Press ▲ or ▼ to highlight “Format”, then press ● to select.
5. Enter your handset code, then press ●.  
A confirmation message is displayed.
6. Press ⏏ [Yes].  
To cancel formatting, press ⏏ [No] in step 6.  
When formatting is complete, a message is displayed.
7. Press ●.

#### Note

- If you enter the wrong handset code in step 5, the operation is cancelled and the screen returns to step 4.
- If the card is locked, you will be requested to unlock it and then perform the aforementioned steps once again.
- If the card is damaged, it cannot be formatted.

### Viewing Memory Card Information (M 9-4-2)

You can see the card type (SD Card or MMC), capacity, and used and free space of memory.

1. Perform steps 1 to 3 in “Formatting Memory Cards” on page 170.
2. Press ▲ or ▼ to highlight “Card Details”, then press ● to select.  
If necessary, press ▲ or ▼ to scroll through the screen.
3. When viewing is complete, press ⏪ [Back].

### Connectivity (M 9-5)

By using this menu, you can connect your phone to a Bluetooth-enabled device via the Bluetooth connection, or to a PC via the Infrared connection or a USB cable.

#### *note*

- *Certain conditions prevent the memory card, USB connection and infrared connections to be accessed simultaneously. In such instances, an alert message is displayed.*

### Using the Bluetooth Function (M 9-5-1)

To Turn the Bluetooth Function On or Off

1. Press ● to display the Main menu.
2. Press ▲, ▼, ◀ or ▶ to highlight “Settings”, then press ● to select.
3. Press ▲ or ▼ to highlight “Connectivity”, then press ● to select.
4. Press ▲ or ▼ to highlight “Bluetooth”, then press ● to select.
5. Press ▲ or ▼ to highlight “Bluetooth On/Off”, then press ● to select.

6. Press ▲ or ▼ to highlight “On”, then press ● to select.

If the infrared setting has been activated, you will be asked whether you wish to deactivate it or not. Press ▢ [Yes].

The Bluetooth setting is activated, and “

### To Search for Devices to be Paired

For using the Bluetooth function, you need to search for other Bluetooth devices to establish contact with your phone. Selected handsfree headsets and handsfree car kits currently include the Bluetooth function. Keep your phone within a distance of 10 metres before searching.

1. Perform steps 1 to 4 in “Using the Bluetooth Function” on page 171.
2. Press ▲ or ▼ to highlight “Search for Devices”, then press ● to select.  
The phone displays the following categories: “Headset”, “Car Kit”, and “All”.
3. Press ▲ or ▼ to highlight the category you wish to search for, then press ● to select.

The phone starts searching for devices within 10 metres. Devices found in the selected category are listed. If you select “All”, the phone lists devices from all categories.

4. Press ▲ or ▼ to highlight the desired device for pairing, then press ● to select.  
If you want to search in other categories, repeat step 3.
5. Enter your passcode, then press ●.

### Note

- If the Bluetooth function is off before searching in step 2, the phone turns the Bluetooth on automatically and starts searching.
- If the infrared function is active, the confirmation screen to deactivate the infrared function is displayed in step 3. Press ▢ [Yes] to deactivate.  
Only the car kits and headsets can be selected in the “All” category list in step 3.
- You can only select one device for pairing. To change the paired device, see “Paired Devices” on page 173.

## Paired Devices

You can activate, rename, and delete the paired device in the list.

### To Activate a Device

1. Perform steps 1 to 4 in “Using the Bluetooth Function” on page 171.
2. Press ▲ or ▼ to highlight “Paired Devices”, then press ● to select.
3. Press ▲ or ▼ to highlight the device you wish to activate, then press ● to select.

### Tip

- You can save battery power by turning the Bluetooth off whilst it is not in use. Turn the Bluetooth function off in “To Turn the Bluetooth Function On or Off” on page 171 or in “To Turn the Bluetooth Function Off Automatically” on page 174.
- During a call, you can divert voice call to the paired Bluetooth device. Press ▢ [Options], then press ▲ or ▼ to highlight “Enable Bluetooth”, then press ● or ▢ [Select] to select. If you wish to disconnect the paired device, select “Disable Bluetooth”.

### To Rename a Device

1. Perform steps 1 to 4 in “Using the Bluetooth Function” on page 171.
2. Press ▲ or ▼ to highlight “Paired Devices”, then press ● to select.
3. Press ▲ or ▼ to highlight the device name you wish to rename, then press ▢ [Options] to display the Options menu.
4. Press ▲ or ▼ to highlight “Change Name”, then press ● or ▢ [Select] to select.
5. Rename the device, then press ●.

### To Clear a Device Name

1. Perform steps 1 to 4 in “Using the Bluetooth Function” on page 171.
2. Press ▲ or ▼ to highlight “Paired Devices”, then press ● to select.
3. Press ▲ or ▼ to highlight the device name you wish to clear, then press ▢ [Options] to display the Options menu.

4. Press ▲ or ▼ to highlight “Delete”, then press ● or ▢ [Select] to select.
5. Press ▲ or ▼ to highlight “One Device”, then press ● to select.
6. Press ▢ [Yes].  
To cancel deletion, press ▢ [No] in step 6.

**Tip**

- To delete all device names, press ▲ or ▼ to highlight “All Devices”, then press ● to select in step 5.

**Bluetooth Settings**

You can prevent other GX30 phones from recognising your phone, or turn the Bluetooth function off automatically to save battery power.

**To Show or Hide Your Phone**

1. Perform steps 1 to 4 in “Using the Bluetooth Function” on page 171.
2. Press ▲ or ▼ to highlight “Bluetooth Settings”, then press ● to select.
3. Press ▲ or ▼ to highlight “Visibility”, then press ● to select.

4. Press ▲ or ▼ to highlight “Shown to All” to allow other Bluetooth-enabled devices to recognise your phone or “Hidden” to hide your phone, then press ● to select.















**To Turn the Bluetooth Function Off Automatically**

1. Perform steps 1 to 4 in “Using the Bluetooth Function” on page 171.
2. Press ▲ or ▼ to highlight “Bluetooth Settings”, then press ● to select.
3. Press ▲ or ▼ to highlight “Bluetooth Time Out”, then press ● to select.
4. Press ▲ or ▼ to highlight the desired time, then press ● to select.

Your phone turns the Bluetooth function off automatically for the specified time.

## Using the Infrared Function (For Modem)

To Turn the Infrared Function On or Off (M 9-5-2)  
Via the Infrared connection, you can use your phone as a modem.

1. Press  to display the Main menu.
2. Press , ,  or  to highlight “Settings”, then press  to select.
3. Press  or  to highlight “Connectivity”, then press  to select.
4. Press  or  to highlight “Modem via Infrared”, then press  to select.
5. Press  or  to highlight “On”, then press  to select.















If the Bluetooth function has been activated, you will be asked whether you wish to deactivate it or not. Press  [Yes].

“” will appear on the screen.

The infrared setting will return to off when no data is transmitted/received via infrared communication.

## PC Software (M 9-5-3)

By connecting your phone to a PC, you can transmit pictures, sounds, video clips, and Contacts List entries. Follow the procedure to select the connection method (USB or Infrared connection). For details on how to get the link software, see page 191.

1. Press  to display the Main menu.
2. Press , ,  or  to highlight “Settings”, then press  to select.
3. Press  or  to highlight “Connectivity”, then press  to select.
4. Press  or  to highlight “PC Software”, then press  to select.
5. Press  or  to highlight “Data Cable” for cable connection or “Infrared” for infrared link, then press  to select.



## Internet Settings (M 9-6)

### WAP/MMS Settings

WAP settings and MMS settings can perform following various setups, respectively. In normal operation, you do not need to change these settings.

#### WAP Settings (M 9-6-1)

Item	Description	Operation
Profile Name*	WAP Profile Name (Unique Name)	Press ▲ or ▼ to highlight "Profile Name" and press ● to select. Enter the desired strings and press ●.
IP Address*	IP address	Press ▲ or ▼ to highlight "IP Address" and press ● to select. Enter IP address for WAP and press ●.
Homepage	Homepage	Press ▲ or ▼ to highlight "Homepage" and press ● to select. Enter Homepage URL, if needed, and press ●.

Item	Description	Operation
Port Number*	Security Option	Press ▲ or ▼ to highlight "Port Number" and press ● to select. Enter Port Number (1024-65535) and press ●.
Circuit Prompt	Circuit Prompt	Press ▲ or ▼ to highlight "Circuit Prompt" and press ● to select. Press ▲ or ▼ to highlight "Enable" or "Disable" and press ● to select.
Connection Type	Bearer Connection Type	Press ▲ or ▼ to highlight "Connection Type" and press ● to select. Press ▲ or ▼ to highlight "GPRS Then CSD", "GPRS" or "CSD" and press ● to select.

GPRS Settings (If "GPRS Then CSD" or "GPRS" is selected as connection type, they should be set)		
Item	Description	Operation
APN*	Access Point Name	Press ▲ or ▼ to highlight "APN" and press ● to select. Enter Access Point Name and press ●.
Username	User Name	Press ▲ or ▼ to highlight "Username" and press ● to select. Enter User Name and press ●.
Password	Password	Press ▲ or ▼ to highlight "Password" and press ● to select. Enter Password and press ●.
Linger Time	Linger Time	Press ▲ or ▼ to highlight "Linger Time" and press ● to select. Enter time in seconds (0-99999) and press ●.

CSD Settings (If "GPRS Then CSD" or "CSD" is selected as connection type, they should be set)		
Item	Description	Operation
Phone No.*	Access Point Number	Press ▲ or ▼ to highlight "Phone No." and press ● to select. Enter Access Point Number and press ●.
Line Type	ISDN or Analogue	Press ▲ or ▼ to highlight "Line Type" and press ● to select. Press ▲ or ▼ to highlight "ISDN" or "Analogue" and press ● to select.
Username	User Name	Press ▲ or ▼ to highlight "Username" and press ● to select. Enter User Name and press ●.
Password	Password	Press ▲ or ▼ to highlight "Password" and press ● to select. Enter Password and press ●.

Item	Description	Operation
Linger Time	Linger Time	Press ▲ or ▼ to highlight "Linger Time" and press ● to select. Enter time in seconds (0-99999) and press ●.

\*: Item to be set as mandatory.

### MMS Settings (M 9-6-2)

Item	Description	Operation
Profile Name*	MMS Profile Name (Unique Name)	Press ▲ or ▼ to highlight "Profile Name" and press ● to select. Enter the desired strings and press ●.
IP Address*	IP address	Press ▲ or ▼ to highlight "IP Address" and press ● to select. Enter IP address for MMS and press ●.
Relay Server URL*	MMS Relay Server	Press ▲ or ▼ to highlight "Relay Server URL" and press ● to select. Enter URL of the Relay Server and press ●.

Item	Description	Operation
Port Number*	Security Option	Press ▲ or ▼ to highlight "Port Number" and press ● to select. Enter Port Number (1024-65535) and press ●.
Connection Type	Bearer Connection Type	Press ▲ or ▼ to highlight "Connection Type" and press ● to select. Press ▲ or ▼ to highlight "GPRS Then CSD", "GPRS" or "CSD" and press ● to select.
GPRS Settings (If "GPRS Then CSD" or "GPRS" is selected as connection type, they should be set)		
APN*	Access Point Name	Press ▲ or ▼ to highlight "APN" and press ● to select. Enter Access Point Name and press ●.

Item	Description	Operation
Username	User Name	Press ▲ or ▼ to highlight "Username" and press ● to select. Enter User Name and press ●.
Password	Password	Press ▲ or ▼ to highlight "Password" and press ● to select. Enter Password and press ●.
Linger Time	Linger Time	Press ▲ or ▼ to highlight "Linger Time" and press ● to select. Enter time in seconds (0-99999) and press ●.
CSD Settings (If "GPRS Then CSD" or "CSD" is selected as connection type, they should be set)		
Phone No.*	Access Point Number	Press ▲ or ▼ to highlight "Phone No." and press ● to select. Enter Access Point Number and press ●.























Item	Description	Operation
Line Type	ISDN or Analogue	Press ▲ or ▼ to highlight "Line Type" and press ● to select. Press ▲ or ▼ to highlight "ISDN" or "Analogue" and press ● to select.
Username	User Name	Press ▲ or ▼ to highlight "Username" and press ● to select. Enter User Name and press ●.
Password	Password	Press ▲ or ▼ to highlight "Password" and press ● to select. Enter Password and press ●.

Item	Description	Operation
Linger Time	Linger Time	Press ▲ or ▼ to highlight "Linger Time" and press ● to select. Enter time in seconds (0-99999) and press ●.



\*: Item to be set as mandatory.

### To Set Up Your Account Information

This information should be supplied by your Internet service provider.









1. Press  to display the Main menu.
2. Press , ,  or  to highlight “Settings”, then press  to select.
3. Press  or  to highlight “Internet Settings”, then press  to select.
4. Press  or  to highlight “WAP Settings” or “MMS Settings”, then press  to select.
5. Press  or  to highlight the profile name you wish to edit, then press  [Options].
6. Press  or  to highlight “Edit”, then press  or  [Select] to select.
7. Press  or  to highlight the item you wish to edit, then press  to select.
8. Edit each item.

### To Select Network Connection Profile

1. Perform steps 1 to 4 in “To Set Up Your Account Information”.
2. Press  or  to highlight the profile name to use, then press  to select.

## Network Settings (M 9-7)

### Opening the Network Settings Screen











1. Press  to display the Main menu.
2. Press , ,  or  to highlight “Settings”, then press  to select.
3. Press  or  to highlight “Network Settings”, then press  to select.

The Network Settings screen is displayed. The following settings can be made.

### Selecting a Network Automatically (M 9-7-1)















Each time the power is turned on, your phone always tries to connect to the preferred network.

If your phone is not connected to the network, you can perform the following immediately to establish the preferred network connection.

















1. Perform steps 1 to 3 in “Opening the Network Settings Screen”.
2. Press , ,  or  to highlight “Select Network”, then press  to select.
3. Press , ,  or  to highlight “Automatic”, then press  to select.



### To Set the Network Manually

Perform the following if you wish to connect to the networks other than the preferred network which is automatically connected to.

1. Perform steps 1 to 3 in “Opening the Network Settings Screen”.
2. Press , ,  or  to highlight “Select Network”, then press  to select.
3. Press , ,  or  to highlight “Manual”, then press  to select.
4. Press , ,  or  to highlight the network from the list, then press  to select.













### Adding a New Network

1. Perform steps 1 to 3 in “Opening the Network Settings Screen”.
2. Press , ,  or  to highlight “Select Network”, then press  to select.
3. Press , ,  or  to highlight “Add New Network”, then press  to select.
4. If there is no entry, perform the following step. If there is an entry, press , then go to step 5.
5. Press , ,  or  to highlight “Add”, then press  to select.



6. Enter the country code, then press .
7. Enter the network code, then press .
8. Enter a new network name and press .









### Editing the Preferred List

#### To Change the Position of a Network in the Preferred List







1. Perform steps 1 to 3 in “Opening the Network Settings Screen” on page 182.
2. Press  or  to highlight “Select Network”, then press .
3. Press  or  to highlight “Set Preferred”, then press .
4. Press  or  to highlight the name of the network to change the position from the list, then press .
5. Press  or  to highlight “Insert” or “Add to end”, then press .

#### To Delete a Network from the Preferred List

1. Perform steps 1 to 3 in “Opening the Network Settings Screen” on page 182.
2. Press  or  to highlight “Select Network”, then press .

3. Press  or  to highlight “Set Preferred”, then press .
4. Press  or  to highlight the name of the network to delete, then press .
5. Press  or  to highlight “Delete”, then press .









### Changing the Network Password (M 9-7-2)

1. Perform steps 1 to 3 in “Opening the Network Settings Screen” on page 182.
2. Press  or  to highlight “Change Password”, then press .
3. Enter the old password, then press .
4. Enter a new password, then press .
5. Enter a new password again, then press . If you enter the incorrect password in step 5, the screen will return to step 2 and you are asked to enter the password again.
6. Press .



## Security (M 9-8)







### Opening the Security Screen

1. Press  to display the Main menu.
2. Press , ,  or  to highlight “Settings”, then press  to select.
3. Press  or  to highlight “Security”, then press  to select.

The Security screen is displayed. The following settings can be made.

### Enabling/Disabling the PIN Code (M 9-8-1)

If the PIN code is enabled you are asked to enter the PIN code each time the phone is switched on. Your PIN code is stored on the SIM card and you should have been made aware of the code when you purchased the SIM card. Contact your service provider for further details.

1. Perform steps 1 to 3 in “Opening the Security Screen”.
2. Press  or  to highlight “PIN Entry”, then press  to select.
3. Press  or  to highlight “On” or “Off”, then press  to select.
4. Enter your PIN code, then press .











5. Press .

### Note

- If you enter the wrong PIN code three times in step 4, the SIM card will lock. To remove the lock, contact your service provider/SIM card vendor.

### To Change PIN Code

This allows you to change the PIN code stored on the SIM card. Before you change the PIN code, select “On” in step 3 in “Enabling/Disabling the PIN Code”.

1. Perform steps 1 to 3 in “Opening the Security Screen”.
2. Press  or  to highlight “PIN Entry”, then press  to select.
3. Press  or  to highlight “Change PIN”, then press  to select.
4. Enter the existing PIN code, then press .
5. Enter a new PIN code, then press .
6. Enter a new PIN code again, then press .  
If you enter a code different from the code which you entered in step 5, the screen returns to step 5. Enter the correct code again.
7. Press .

### Handset Lock (M 9-8-2)

The Handset Lock is an additional security feature which prevents unauthorised use of the phone or certain features. The default handset lock code is “0000”.

1. Perform steps 1 to 3 in “Opening the Security Screen” on page 184.
2. Press ▲ or ▼ to highlight “Handset Lock”, then press ● to select.
3. Press ▲ or ▼ to highlight “On” or “Off”, then press ● to select.
4. Enter your handset code, then press ●.  
If you enter an incorrect handset code, the screen will clear and you are prompted to enter the code again.

### To Change Handset Code

Before you change the handset code, select “On” in step 3 in “Handset Lock”. The default handset code is “0000”.

1. Perform steps 1 to 3 in “Opening the Security Screen” on page 184.
2. Press ▲ or ▼ to highlight “Handset Lock”, then press ● to select.
3. Press ▲ or ▼ to highlight “Change Code”, then press ● to select.

4. Enter the old handset code, then press ●.
5. Enter a new handset code, then press ●.
6. Enter the new handset code again, then press ●.  
If you enter a code different from the code which you entered in step 5, the screen returns to step 4. Enter the correct code again.

### Changing PIN2 Code (M 9-8-3)

PIN2 code is used to protect certain functions in the phone such as Fixed Dialling No. and call cost limits. The following shows you how to change PIN2 code.

1. Perform steps 1 to 3 in “Opening the Security Screen” on page 184.
2. Press ▲ or ▼ to highlight “Change PIN2”, then press ● to select.
3. Enter the existing PIN2 code, then press ●.
4. Enter a new PIN2 code, then press ●.
5. Enter the new PIN2 code again, then press ●.  
If you enter a code different from the code which you entered in step 4, the screen returns to step 4. Enter the correct code.
6. Press ●.

### Call Barring (M 9-8-4)

This function lets you place restrictions on incoming and outgoing calls. To activate Call Barring you will need the call barring password, which is available from your service provider.

1. Perform steps 1 to 3 in “Opening the Security Screen” on page 184.
2. Press ▲ or ▼ to highlight “Call Barring”, then press ● to select.
3. Press ▲ or ▼ to highlight call barring option, then press ● to select.

The call barring functions available are:

- “Bar Foreign Calls”: Restricts all outgoing international calls.
  - “Only Local & Home”: Restricts all outgoing international calls except to your home country.
  - “Bar Incoming Calls”: Restricts all incoming calls.
  - “Bar Inc if Abroad”: Restricts all incoming calls when you are outside of the coverage from your registered network operator.
  - “Bar Outgoing Calls”: Restricts all outgoing calls except emergency calls.
4. Press ▲ or ▼ to highlight one of the call barring options, then press ● to select.

The call barring options available are:

- “All services”: Restricts all services.
- “Voice Calls”: Restricts all voice calls.
- “Data”: Restricts all data calls.
- “Fax”: Restricts all fax calls.
- “Messages”: Restricts all messages.
- “All except msgs”: Restricts all services except messages.







5. Press ▲ or ▼ to highlight “On”, then press ● to select.

If you select “Status”, you can check the status of the selected call barring option.







When you finish the confirmation, press ⏪ [Back].







6. Enter the network password, then press .  
To change the network password, see “Changing the Network Password” on page 183.  
The selected call barring function is activated.  
If you enter a wrong network password, the entered password is cleared. Enter the correct password.

#### To Cancel All Call Barring Settings

1. Perform steps 1 to 3 in “Opening the Security Screen” on page 184.
2. Press  or  to highlight “Call Barring”, then press  to select.
3. Press  or  to highlight “Cancel All”, then press  to select.
4. Enter the network password, then press .  
All call barring settings are cancelled.

#### To Cancel the Call Barring Setting Individually











1. Perform steps 1 to 3 in “Opening the Security Screen” on page 184.
2. Press  or  to highlight “Call Barring”, then press  to select.
3. Press  or  to highlight the call barring option, then press  to select.

4. Press  or  to highlight the call barring option you wish to cancel, then press  to select.
5. Press  or  to highlight “Off”, then press  to select.
6. Enter the network password, then press .  
The selected call barring setting is cancelled.

#### Fixed Dialling No. (M 9-8-5)

When the Fixed Dialling No. is enabled, you can only call predefined numbers.

#### To Enable Fixed Dialling No.

1. Perform steps 1 to 3 in “Opening the Security Screen” on page 184.
2. Press  or  to highlight “Fixed Dialling No.”, then press  to select.
3. Enter a PIN2 code, then press .
4. Press  or  to highlight “Settings”, then press  to select.
5. Press  or  to highlight “On”, then press  to select.  
If you select “Off”, Fixed Dialling No. is disabled.

### To Add a New Name

1. Perform steps 1 to 3 in “Opening the Security Screen” on page 184.
2. Press ▲ or ▼ to highlight “Fixed Dialling No.”, then press ● to select.
3. Enter a PIN2 code, then press ●.
4. Press ▲ or ▼ to highlight “Edit Dial List”, then press ● to select.
5. Press ▢ [Options] to display the Options menu.
6. Press ▲ or ▼ to highlight “Add New Contact”, then press ● or ▢ [Select] to select.
7. Add a name and a phone number.  
For details on adding a name and a phone number, see “Add New Contact” on page 39.
8. Press ▢ [Save] to save.

### To Search a Registered Name

1. Perform steps 1 to 3 in “Opening the Security Screen” on page 184.
2. Press ▲ or ▼ to highlight “Fixed Dialling No.”, then press ● to select.
3. Enter a PIN2 code, then press ●.
4. Press ▲ or ▼ to highlight “Edit Dial List”, then press ● to select.
5. Press ▢ [Options] to display the Options menu.
6. Press ▲ or ▼ to highlight “Search”, then press ● or ▢ [Select] to select.
7. Search for the desired name.  
For details on searching a name, see “Finding a Name and Number” on page 43.

### To Edit a Registered Name

1. Perform steps 1 to 3 in “Opening the Security Screen” on page 184.
2. Press ▲ or ▼ to highlight “Fixed Dialling No.”, then press ● to select.
3. Enter a PIN2 code, then press ●.
4. Press ▲ or ▼ to highlight “Edit Dial List”, then press ● to select.

5. Press ▲ or ▼ to highlight a name you wish to edit, then press ⏏ [Options] to display the Options menu.
6. Press ▲ or ▼ to highlight “Edit”, then press ● or ⏏ [Select] to select.
7. Edit the selected name.  
For details on editing a name, see “Editing Contacts List Entries” on page 44.











#### To Delete a Registered Name

1. Perform steps 1 and 3 in “Opening the Security Screen” on page 184.
2. Press ▲ or ▼ to highlight “Fixed Dialling No.”, then press ● to select.
3. Enter a PIN2 code, then press ●.
4. Press ▲ or ▼ to highlight “Edit Dial List”, then press ● to select.
5. Press ▲ or ▼ to highlight a name you wish to delete, then press ⏏ [Options] to display the Options menu.
6. Press ▲ or ▼ to highlight “Delete”, then press ● or ⏏ [Select] to select.

7. Press ⏏ [Yes].  
The selected name is deleted.  
To cancel deletion, press ⏏ [No] in step 7.

## Master Reset (M 9-9)

All settings can be reset to their default settings.

1. Press  to display the Main menu.
2. Press , ,  or  to highlight “Settings”, then press  to select.
3. Press  or  to highlight “Master Reset”, then press  to select.
4. Enter your handset code, then press .
5. Press  [Yes].

All settings are reset.

To cancel resetting, press  [No] in step 5.

### **Note**

- *If you enter a wrong handset code in step 4, the operation is cancelled.*

## **Connecting GX30 to Your PC**

You can use the following functions by connecting the GX30 to your PC using an infrared port or USB port\*:

- GSM/GPRS modem
  - Handset Manager for GX30
- \* Requires an optional USB data cable XN-1DC30 for USB port connection.

### **System Requirements**

Operating System: Windows<sup>®</sup> 98\*, Windows<sup>®</sup> Me, Windows<sup>®</sup> 2000\*\*, Windows<sup>®</sup> XP\*\*\*

- \* Windows<sup>®</sup> 98 Second Edition, Windows<sup>®</sup> 98 Service Pack 1
- \*\* Service Pack 4
- \*\*\*Service Pack 1a

Interface: Infrared port or USB port  
CD-ROM drive

### **GSM/GPRS Modem**

You can use GX30 as a GSM/GPRS modem to access the Internet from your PC. Connect your phone to your PC via the Infrared connection or a USB cable and install the necessary software. For details, see “Software Installation” on page 192.

### **Modem via the Infrared Connection**

To use the modem function via the Infrared connection, see “Using the Infrared Function (For Modem)” on page 175 and turn the modem function on.

### **Modem via the USB Cable**

To use the modem function using a USB cable, use the cable mentioned above and see the instructions accompanying the cable.

For details on software support, refer to the following site:

<http://www.sharp-mobile.com>

#### **Note**

- *Modem communication is not possible whilst communicating with the Handset Manager via the Infrared connection or USB cable.*

### **Handset Manager**

You can transmit picture, sound and video clip, and Contacts List entries between your phone and your PC, and can use Contacts List entries on your PC.

To use the Handset Manager function, see “PC Software” on page 175 and set your phone to Data Transfer mode.

For details on software support, refer to the following site:

<http://www.sharp-mobile.com>



## Software Installation

1. Insert the supplied CD-ROM into your CD-ROM drive.  
The GX30 CD-ROM screen is displayed.  
If the GX30 CD-ROM screen is not displayed, double-click [Launcher.exe] in your CD-ROM.
2. Press the desired button.  
The installation starts.
3. Follow the on-screen instructions to complete installation.

## Note

### *Infrared communication*

- *Infrared ports need to be aligned with each other.*

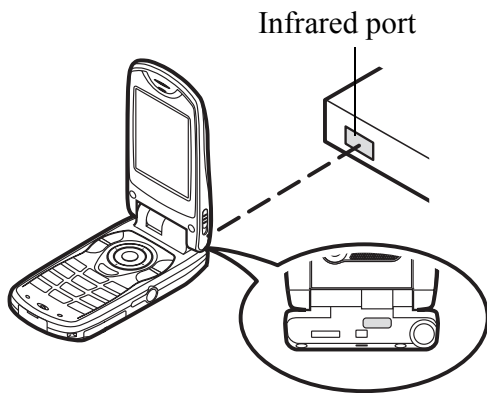

- *Infrared ports need to be placed within 20 cm of each other and within a 30° angle.*
- *It is not recommended that you make or answer a call during data transmission. The operation may be interrupted.*

### **GSM/GPRS modem**

- *It is not recommended that you make or answer calls when you are using GX30 as a GSM/GPRS modem. The operation may be interrupted.*
- *When transmitting data via infrared communication, you need to set the infrared setting to “On”. (p. 175)*

### **Handset Manager**

- *Some large files may not be able to be transmitted from the PC to the phone.*
- *When connecting your phone to a PC, you need to select the connection method for PC Software. (p. 175)*
- *You cannot read or write PC data (JPEG, MP3, 3gp, MPEG4, etc.) directly to the memory card inserted in the phone. Use a commercially available PC card adapter or memory card reader/writer to transfer data from the PC to the memory card.*
- *The phone may not recognize the USB data cable if it is connected whilst an application (Camera, My Stuff, MP3 Player, etc.) is running. Connect the USB data cable during stand-by.*
- *Applications (Camera, My Stuff, MP3 Player, etc.) do not run when the phone is connected to the PC by IrDA or USB data cable.*

## Troubleshooting

Problem	Solution
The phone does not turn on.	<ul style="list-style-type: none"> <li>• Make sure the battery is properly inserted and charged.</li> </ul>
PIN code or PIN2 code is rejected.	<ul style="list-style-type: none"> <li>• Make sure you have entered the correct code (4 to 8 digits).</li> <li>• Your SIM card/protected functions will become locked after 3 unsuccessful attempts.</li> <li>• Contact your SIM provider if you do not have the correct PIN code.</li> </ul>
The SIM card becomes locked.	<ul style="list-style-type: none"> <li>• Enter PUK code (8 digits) provided by your service provider (if supported).</li> <li>• If the attempt is successful, enter the new PIN code and confirm your phone is operational again. Otherwise contact your dealer.</li> </ul>
The display is difficult to read.	<ul style="list-style-type: none"> <li>• Adjust the backlight brightness for the main display, and adjust the LCD contrast for the external display.</li> </ul>

Problem	Solution
Phone functions do not work after the phone is turned on.	<ul style="list-style-type: none"> <li>• Check the radio signal strength indicator as you may be outside the service area.</li> <li>• Check to see if any error message is displayed when you turn your phone on. If so, contact your dealer.</li> <li>• Make sure the SIM card is correctly inserted.</li> </ul>
Calls cannot be made or received.	<ul style="list-style-type: none"> <li>• If the message "SIM Card Error" is displayed at start-up, you cannot use your SIM card or the SIM card is damaged. Contact your dealer or network service provider.</li> <li>• Check your call barring, fixed dialling setting, remaining battery and call forwarding settings.</li> <li>• Check if your phone is currently performing data communication using Infrared (IrDA) or a data cable.</li> <li>• Check the remaining balance if you are using a pre-paid SIM card.</li> </ul>

Problem	Solution
Call quality is poor.	<ul style="list-style-type: none"> <li>Your current location may not provide good call quality (i.e., in a car or train). Move to a location where radio signal strength is greater.</li> </ul>
Cannot access network service.	<ul style="list-style-type: none"> <li>Check where your account has been registered and where the service is available.</li> </ul>
Cannot send or receive Text Message.	<ul style="list-style-type: none"> <li>Make sure you are correctly subscribed for the Short Message Service, that the network supports this service, and that the centre number is set up correctly. If not, contact your network service provider.</li> </ul>
Cannot connect to Multimedia Message service provider.	<ul style="list-style-type: none"> <li>MMS settings and configuration may be missing or incorrect or the network does not support it. Check your service provider's access point number. Contact your service provider to confirm the correct settings.</li> </ul>

Problem	Solution
Limited memory available.	<ul style="list-style-type: none"> <li>Delete any unnecessary data.</li> </ul>
Call is terminated unexpectedly.	<ul style="list-style-type: none"> <li>Magnetised objects such as health necklaces placed near the phone may terminate the call. Keep your phone away from such objects.</li> </ul>
No entries are displayed in the Contacts List	<ul style="list-style-type: none"> <li>Confirm that the Contacts Location setting (Handset or SIM) and View Groups setting are made correctly.</li> </ul>
Fax transmission failure	<ul style="list-style-type: none"> <li>Before transmitting fax data, configure your fax software to use the software flow control.</li> <li>Use of the optional data cable is recommended for transmitting fax data.</li> </ul>

## **Safety Precautions and Conditions of Use**

Your phone conforms to international regulations insofar as it is used under normal conditions and in accordance with the following instructions.

### **CONDITIONS OF USE**

#### **Electromagnetic waves**

- Do not switch on your phone aboard an aircraft (as your phone may interfere with the aircraft's electronic systems). Current legislation forbids this use and legal action can be taken against the user.
- Do not switch on your phone in a hospital, except in designated areas.
- Use of your phone's function may affect the performance of medical electronic units (pacemakers, hearing aids, insulin pumps, etc.). When the phone function is on, do not bring it near medical equipment or into areas in which medical equipment is being used. If you have a hearing aid or a pacemaker, only use the phone on the opposite side of your body from where it is located. The phone should be kept at least 6 inches (15.24 cm) from a pacemaker ANYTIME the phone is switched on.

- Do not switch on your phone near gas or flammable substances.
- Observe the rules concerning the use of mobile phones at gasoline stations, chemical plants and at all sites where a risk of explosion exists.

#### **Caring for your phone**

- Do not allow children to use your phone without supervision.
- Do not open or attempt to repair your phone yourself. The product can only be repaired by authorised service personnel.
- Do not drop your phone or subject it to severe impacts. Bending the body and pushing the display or keys with extreme force could damage the phone.
- Do not use solvents to clean your phone. Use only a soft, dry cloth.
- Do not carry your phone in your back pocket as it could break when you sit down. The display is made of glass and is particularly fragile.
- Avoid touching the external connector on the underside of the phone, since the delicate components within can be damaged by static electricity.

## **Battery**

- Use your phone only with batteries, chargers and accessories recommended by the manufacturer. The manufacturer disclaims any liability for damage caused by the use of other chargers, batteries or accessories.
- **Network configuration and phone usage will affect talk-time and stand-by time.**  
Using the games or camera will hasten battery consumption.
- **When the battery charging alert is displayed on the screen, charge the battery as soon as possible.** If you continue using your phone ignoring the alert, the phone may cease to function, and all data and settings you have stored may be lost at any moment.
- Before removing the battery from the phone, make sure the phone is switched off.
- Replace and charge the new battery as soon as possible after removing the old one.
- Do not touch the battery terminals. Batteries can cause damage, injury or burns if a conductive material touches exposed terminals. When the battery is detached from the phone, use a cover made of non-conductive material for keeping and carrying the battery safely.

- Recommended temperature for using and storing batteries is approximately 20°C.
- The batteries' performance is limited in low temperatures, particularly below 0°C and the phone may not work temporarily regardless of the amount of remaining battery power.
- Exposing the phone to extreme temperatures will shorten battery life.
- The battery can be charged and discharged hundreds of times but it will eventually wear out. When the operating time (talk-time and stand-by time) is noticeably shorter than normal, it is time to buy a new battery.

### CAUTION

RISK OF EXPLOSION IF BATTERY IS REPLACED  
BY AN INCORRECT TYPE,  
DISPOSE OF USED BATTERIES ACCORDING  
TO THE INSTRUCTIONS

See "Battery Disposal" on page 14.

### **Memory Card**

- Do not remove or insert a memory card whilst data on the card is being edited. Do not turn off the handset or device containing the memory card whilst data on the card is being edited as this may damage the data or cause the card to stop functioning correctly.
- Data may be lost under the following circumstances.
  - If the handset is dropped, or shook, or force is applied whilst the memory card is inserted.
  - When the handset is used in areas that are exposed to static electricity or electric noise.
- Backup your important data in case data on the memory cards are lost due to malfunctions.
- Do not touch the metal terminals with your hands or metal objects.
- Do not bend the memory card or subject it to violent impact. Keep it away from water and high temperatures.
- SHARP holds no responsibility for the loss or damage of data contained on a memory card.
- Keep all memory cards out of the reach of small children.

### **Aerial Care**

- Do not touch the aerial unnecessarily, whilst using the mobile phone. If it is held, call quality may be hindered leading to shortened talk-time and stand-by time because the mobile phone may have to operate on a higher power level than is necessary.
- Use only the aerial supplied or one approved by Sharp for your mobile phone. Using unauthorised or modified aerials may damage the mobile phone. Moreover, since the mobile phone may violate the appropriate regulations, it may lose performance or exceed the limitation of SAR levels.
- To avoid impaired performance, do not damage the aerial of the mobile phone.
- Whilst talking directly to the microphone, please hold the mobile phone so that the aerial is upwards over your shoulder.
- To avoid interfering with blasting operations, please turn off the mobile phone in a blasting area or in a place where a “turn off two-way radio” sign is posted.

### **Camera Operation**

- Learn picture quality, file formats, etc. beforehand.  
The taken pictures can be saved in JPEG format.
- Be careful not to move your hand whilst taking pictures.  
If the phone moves whilst taking a picture, the picture can be blurred. When taking a picture, hold the phone firmly to prevent it from moving, or use the delay timer.
- Clean the lens cover before taking a picture.  
Fingerprints, oils, etc. on the lens cover hinder clear focusing. Wipe them off with a soft cloth before taking a picture.

### **Others**

- As with any electronic storage unit, data may be lost or corrupted under various circumstances.
- Before connecting the phone with a PC or a peripheral unit, read the operation manual for the other unit carefully.
- If the phone's battery has been removed for some time, or the phone has been reset, the unit's clock and calendar may be reinitialised. The date and time should be updated in this case.

- Use only the attached handsfree kit. Some phone's functions may not work when unauthorised handsfree kit are used.
- The phone uses the magnet to recognise that the phone is closed. Do not place magnetic cards near your phone or get the card caught in the phone as it may damage the recorded data.
- Do not flash the mobile light into eyes as this may damage eyesight or cause dizziness leading to accidents or injury.

### **ENVIRONMENT**

- Keep your phone away from extreme heat. Do not leave it on the dashboard of a car or near a heater. Do not leave it in any place that is extremely damp or dusty.
- Since this product is not waterproof, do not use it or store it where fluids such as water can splash onto it. Raindrops, water spray, juice, coffee, steam, perspiration, etc. will also cause a malfunction.

## **PRECAUTIONS CONCERNING VEHICLE USE**

- It is the user's responsibility to check the local laws governing the use of a mobile phone in vehicles. Pay full attention to driving. Pull off to the side of the road, park the car, and switch off the engine before making or answering a call.
- Use of your phone's function may interfere with the vehicle's electronic systems, such as the ABS anti-lock brakes or the air-bag. To ensure no such problem occurs, please check with your dealer or car manufacturer before connecting your phone.
- Only allow qualified service maintenance personnel to install the vehicle accessories.

The manufacturer disclaims any liability for damage which may result as a consequence of improper use or use contrary to the instructions contained herein.

## **SAR**

Your Sharp mobile phone has been designed, manufactured and tested so as not to exceed the limits for exposure to electromagnetic fields recommended by the Council of the European Union. These limits are part of comprehensive guidelines developed by independent scientific organisations. The guidelines include a substantial safety margin designed to assure the safety of the phone user and others and to take into account variations in age and health, individual sensitivities and environmental conditions. European standards provide for the amount of radio frequency electromagnetic energy absorbed by the body when using a mobile phone to be measured by reference to the Specific Absorption Rate (SAR). The SAR limit for the general public is currently 2 watts per kilogram averaged over 10 grams of body tissue. Your Sharp mobile phone SAR value is 0.377 watts per kilogram. This has been tested to ensure that this limit is not exceeded even when the phone is operating at its highest certified power. In use however your Sharp mobile phone may operate at less than full power because it is designed to use only sufficient power to communicate with the network.



## **PRECAUTIONS FOR USE IN USA**

### **FCC Declaration of Conformity**

This mobile phone GX30 with PC/Data interface cable XN-1DC30 complies with part 15 of the FCC Rules.

Operation is subject to the following two conditions:

- (1) This device may not cause harmful interference, and
- (2) this device must accept any interference received, including interference that may cause undesired operation.

Responsible Party:

SHARP ELECTRONICS CORPORATION

Sharp Plaza, Mahwah, New Jersey 07430

TEL: 1-800-BE-SHARP

Tested To Comply With FCC Standards  
FOR HOME OR OFFICE USE



### **FCC Notice**

The phone may cause TV or radio interference if used in close proximity to receiving equipment. The FCC can require you to stop using the phone if such interference cannot be eliminated.

### **Information To User**

This equipment has been tested and found to comply with the limits of a Class B digital device, pursuant to Part 15 of the FCC Rules. These limits are designed to provide reasonable protection against harmful interference in a residential installation. This equipment generates, uses and can radiate radio frequency energy and, if not installed and used in accordance with the instructions, may cause harmful interference to radio communications.

However, there is no guarantee that interference will not occur in a particular installation; if this equipment does cause harmful interference to radio or television reception, which can be determined by turning the equipment off and on, the user is encouraged to try to correct the interference by one or more of the following measures:

1. Reorient/Relocate the receiving antenna.
2. Increase the separation between the equipment and receiver.
3. Connect the equipment into an outlet on a circuit different from that to which the receiver is connected.
4. Consult the dealer or an experienced radio/TV technician for help.

**CAUTION:** Changes or modifications not expressly approved by the manufacturer responsible for compliance could void the user's authority to operate the equipment.

### **Exposure to Radio Waves**

#### **THIS MODEL PHONE MEETS THE GOVERNMENT'S REQUIREMENTS FOR EXPOSURE TO RADIO WAVES.**

Your wireless phone is a radio transmitter and receiver. It is designed and manufactured not to exceed the emission limits for exposure to radio frequency (RF) energy set by the Federal Communications Commission of the U.S. Government. These limits are part of comprehensive guidelines and establish permitted levels of RF energy for the general population. The guidelines are based on standards that were developed by independent scientific organizations through periodic and thorough evaluation of scientific studies. The standards include a substantial safety margin designed to assure the safety of all persons, regardless of age and health.

The exposure standard for wireless mobile phones employs a unit of measurement known as the Specific Absorption Rate, or SAR. The SAR limit set by the FCC is 1.6W/kg.\* Tests for SAR are conducted using standard operating positions specified by the FCC with

the phone transmitting at its highest certified power level in all tested frequency bands. Although the SAR is determined at the highest certified power level, the actual SAR level of the phone while operating can be well below the maximum value. This is because the phone is designed to operate at multiple power levels so as to use only the power required to reach the network. In general, the closer you are to a wireless base station antenna, the lower the power output.

Before a phone model is available for sale to the public, it must be tested and certified to the FCC that it does not exceed the limit established by the government-adopted requirement for safe exposure. The tests are performed in positions and locations (e.g., at the ear and worn on the body) as required by the FCC for each model. The highest SAR value for this model phone when tested for use at the ear is 0.552 W/kg and when worn on the body, as described in this user guide, is 0.706 W/kg. Body-worn Operation; This device was tested for typical body-worn operations with the back of the phone kept 1.5 cm from the body. To maintain compliance with FCC RF exposure requirements, use accessories that maintain a 1.5 cm separation distance between the user's body and the back of the phone. The use of belt-clips, holsters and similar accessories should not contain metallic components in its assembly.

The use of accessories that do not satisfy these requirements may not comply with FCC RF exposure requirements, and should be avoided. While there may be differences between the SAR levels of various phones and at various positions, they all meet the government requirement for safe exposure.

The FCC has granted an Equipment Authorization for this model phone with all reported SAR levels evaluated as in compliance with the FCC RF emission guidelines. SAR information on this model phone is on file with the FCC and can be found under the Display Grant section of <http://www.fcc.gov/oet/fccid> after searching on FCC ID APYHRO00033.

Additional information on Specific Absorption Rates (SAR) can be found on the Cellular Telecommunications & Internet Association (CTIA) web-site at <http://www.phonefacts.net>.

\* In the United States and Canada, the SAR limit for mobile phones used by the public is 1.6 watts/kg (W/kg) averaged over one gram of tissue. The standard incorporates a substantial margin of safety to give additional protection for the public and to account for any variations in measurements.

## **Index**

### **Symbols**

# key 10

\* /Shift key 9

### **A**

Accessories 7

Alarm 121

    Changing alarm settings 123

    Disabling alarm function 123

    Resetting alarm setting 123

    Resetting all alarm settings 123

    Setting alarms 121

Any Key Answer 144

Applications 117

    Alarm 121

    Calculator 124

    Calendar 118

    Melody Editor 127

    MP3 Player 117

    Phone Help 136

    SIM Application 117

    Voice Recorder 125

Area Info 86

    Enabling/Disabling 86

### **B**

Battery 11

    Charging 15

    Disposal 14

    Inserting 11

    Removing 13

Battery level indicator 15

Bookmarks 89

    Accessing bookmarked pages  
    89

    Adding a bookmark 89

    Deleting bookmarks 90

    Editing bookmarks 90

Busy tone 26

### **C**

Calculator 124

    Rate conversion 124

Calendar 118

    Deleting schedules 120

    Finding a particular date 119

Call 24

    Answering 26

    Ending 25

    Holding 27

    Making 24

    Making another call during a  
    call 27

    Putting on hold 27

    Rejecting 26

Call Costs 147

    Checking charge limit 149

    Checking charge rate 148

    Checking cost of last call 147

    Checking residual credit 149

    Checking total call cost 148

    Resetting all call costs 149

    Setting charge limit 148

    Setting charge rate 148

Call Log 145

    Deleting 146

    Sending messages 145

    Viewing 145

Call Settings 165

    Adjusting earpiece volume 166

    Auto Answer 167

    Auto Redial 167

    Call waiting 165

    Display Call Timers 166

    Minute Minder 167

- Resetting 167
- Show Your No. 166
- Call Timers 146
  - Checking duration of last call 146
  - Checking total call time 147
  - Resetting all call timers 147
- Call waiting 28, 165
- Camera 10, 51
  - Selecting the memory 51
- Cell Broadcasts 84
  - Enabling/Disabling 84
  - Reading 85
  - Setting languages 85
  - Subscribing 85
- Centre key 9
- Centre key/Navigation keys 19
- Characters 32
  - Changing input method 33
  - Changing the input languages 33
  - Copying text 34
  - Cuttings text 34
  - Entering 32
  - Pasting text 34
  - Symbols and punctuation 33
  - T9 text input 33
  - Table of characters 32

- Conference call 29
  - Adding new participants 30
  - Ending call with a participant 30
  - Making a conference call 29
  - Private conversation 30
- Connectivity 171
  - Bluetooth function 171
  - Infrared function 175
  - PC Software 175
- Contacts List 38
  - Adding number from call Log 41
  - Changing the memory to be used 38
  - Creating 39
  - Deleting 45
  - Dialling 43
  - Editing 44
  - Finding 43
  - Memory status 48
  - Sending messages 49
  - Storing input number 41
  - Swapping location number of the phone number 50
  - Viewing groups 45

**D**

- Data Counter 150
  - Resetting 150
- Delivery report
  - Confirming 75
- Dial tone
  - Muting 31
- Digital camera
  - Adjusting the brightness of the picture 56
  - Continuous shooting 57
  - Deleting pictures 59
  - Indicators 54
  - Retaking pictures 53
  - Selecting light colour 58
  - Selecting the frame 58
  - Selecting the memory 51
  - Selecting the picture quality 53
  - Selecting the picture size 53
  - Selecting the shutter sound 59
  - Selecting the shutter speed 59
  - Sending messages 97
  - Sending pictures 59
  - Switching the viewfinder 52
  - Taking close-up pictures 53
  - Taking pictures 51
  - Using the timer 56

- Using the zoom function 53
- Viewing the taken pictures 56
- Display indicators
  - External display 22
  - Main display 9, 19
- Diverts 168
  - Canceling all divert settings 169
  - Canceling divert settings individually 170
  - Checking divert status 169
  - Divert calls 168
- DTMF tone 31
  - Muting 31
- E**
- Earpiece 9
- Earpiece volume 27
  - Adjusting 27
- Emergency calls 24
- End/Power key 10
- External connector 11
- F**
- Flash light 10
- G**
- Games & More 99
  - Backlight 113
- Checking information 100
- Clearing all applications 116
- Deleting 101
- Downloading 99
- Executing 100
- Screensavers 111
- Settings 112
- Group call 46
- H**
- Handsfree kit connector 11
- I**
- Infrared port 10
- Input languages
  - Changing 33
- Input method 33
  - Changing 33
- International calls 24
- Internet settings 176
- L**
- Left soft key 9, 19
- Light Colour 140
- M**
- Macro switch 11
- Main menu 35
  - List of menu functions 37
- Operation guidance 35
- Shortcut keys 35
- Master reset 190
- Melody Editor 127
  - Copying/Pasting notes 135
  - Creating your original ringtone 127
  - Editing 134
  - Musical scale/rest 129
  - Strength 134
  - Tone 131
  - Types of notes/rests 130
- Memory card
  - Formatting 170
  - Inserting 16
  - Making a backup file 47
  - Removing 18
  - Viewing information 171
- Memory status 110
- Menu 35
  - Main menu 35
  - Operation guidance 35
  - Shortcut keys 35
- Messages
  - MMS 66
  - SMS 77

- Microphone 10
  - Muting 31
- Mobile light 10, 15
- MP3 Player 117
  - Playing back 117
- Multimedia Message 66
  - Adding recipients 68
  - Check the sender and receiver phone number or e-mail address 72
  - Creating 66
  - Deleting 75
  - Forwarding 73
  - Inserting attached data 69
  - Lock/Unlock 76
  - Making a call 76
  - Modifying 73
  - Reading 71
  - Replying 72
  - Re-sending 74
  - Retrieving 74
  - Saving in Drafts box 68
  - Sending message in Drafts box 71
  - Setting up 76
- Storing the phone number or e-mail address of a sender in the Contacts List 74
- Turning the slide show setting on or off 69
- My Numbers 151
- My Stuff 92
- N**
- Navigation keys (Arrow keys) 9, 35
- Network settings 182
  - Adding new network 182
  - Changing network password 183
  - Editing preferred list 183
  - Selecting a network automatically 182
- P**
- PC connection
  - GSM/GPRS modem 191
  - Handset Manager 191
  - Software installation 192
  - System requirements 191
- Phone settings 152
  - Assigning pictures 159
  - Backlight 156
  - Brightness of backlight 157
  - Changing language 152
  - Display saving 158
  - External display 160
  - Greeting message 158
  - Main display 155
  - Resetting 164
  - Setting time zone 154
- Pictures 92
  - Adjusting size 97
  - Changing file name 96
  - Checking information 98
  - Copying or moving 96
  - Deleting 98
  - Downloading 96
  - Editing pictures 94
  - Saving to Contacts List 93
  - Sending messages 97
  - Using as wallpaper 93
  - Viewing 92
- PIN code 184
- PIN2 code 185
- Profiles 137
  - Activating 137
  - Any Key Answer 144
  - Customising 138
  - Echo reduction 143
  - Keypad tones 140

- Low battery alert 143
  - Message alert 142
  - Power on/off sound 142
  - Resetting 138
  - Ringer volume 139
  - Vibration 140
  - Warning tone 141
- R**
- Redialling 25
    - Auto redial 25
  - Right soft key 9, 19
  - Ringtone
    - Assigning a Ringtone to Each
      - Contacts List Entry 47
    - Using the sounds in the handset
      - memory 103
- S**
- SAR 199
  - Screensavers 111
  - Security 184
    - Call Barring 186
    - Changing handset code 185
    - Changing PIN code 184
    - Changing PIN2 code 185
    - Enabling/Disabling PIN code
      - 184
  - Fixed Dialling No. 187
  - Handset Lock 185
  - Send key 9
  - Settings 152
    - Call settings 165
    - Connectivity 171
    - Date & Time 152
    - Diverts 168
    - Internet 176
    - Master Reset 190
    - MMS 178
    - Network settings 182
    - Phone settings 152
    - Security 184
    - WAP 176
  - SIM card 11
    - Inserting 11
    - Removing 13
  - Sounds 102
    - Changing file name 104
    - Checking information 103
    - Copying or moving 103
    - Deleting 105
    - Downloading 102
    - Playing back 102
    - Sending messages 104
    - Strength 104
  - Tone 104
  - Speaker 10
  - Speed Dial List 150
    - Assign 150
    - Clear All 151
    - Delete 151
    - Re-assign 150
  - Speed dialling 24, 49
  - Status indicators 19
- T**
- Text (SMS) 77
  - Text message 77
    - Calling 81
    - Connection type 84
    - Creating 78
    - Deleting 82
    - Extracting phone numbers 82
    - Forwarding 81
    - Message format 83
    - Modifying 81
    - Optimisation 84
    - Reading 80
    - Replying 80
    - Saving in Drafts box 78
    - Sending 78
    - Setting up 83
    - Validity period 83



- Text template 109
  - Adding phrases 109
  - Deleting 110
  - Editing 109
  - Using 34, 68, 78
  - Viewing 109
- Troubleshooting 193
- Turning your phone on and off 18
- V**
- Video camera
  - Adjusting the brightness of the video clips 63
  - Deleting video clips 65
  - Indicators 62
  - Recording close-up video clips 61
  - Recording video clips 60
  - Recording video clips with sound 64
  - Selecting light colour 65
  - Selecting the memory 59
  - Selecting the recording time mode 61
  - Selecting the video quality 61
  - Sending video clips 65
  - Using the timer 64
  - Using the zoom function 61
  - Viewing the recorded video clips 63
- Video clips 105
  - Changing file name 107
  - Checking information 106
  - Copying or moving 106
  - Deleting files 108
  - Downloading 105
  - Playing back 106
  - Sending messages 107
- Viewfinder switch key 9
- Vodafone live! 87
  - Browser menu 88
  - Exiting WAP browser 87
  - Navigating WAP page 88
  - Viewing WAP browser 87
- Voice mail key 9
- Voice Recorder 125
  - Playing back 126
  - Recording 125
  - Selecting the memory 125
  - Selecting the recording time mode 126
  - Sending voice clips 127